

PERFORMANCE AUTOMOTIVE GASKETS

Domestic and Import

2026



Gasket Development

Cometic provides customers with quality products, born of exhaustive research and development.

Cometic's Superflow 902S Dynamometer positions us a leader in gasket design and technology, and affords us the ability to analyze gasket designs and materials in the most extreme conditions. Alongside our in-house research and development, we also collaborate with our performance partners, who compete in the most exacting environments, to ensure your gasket won't fail when you need it most.

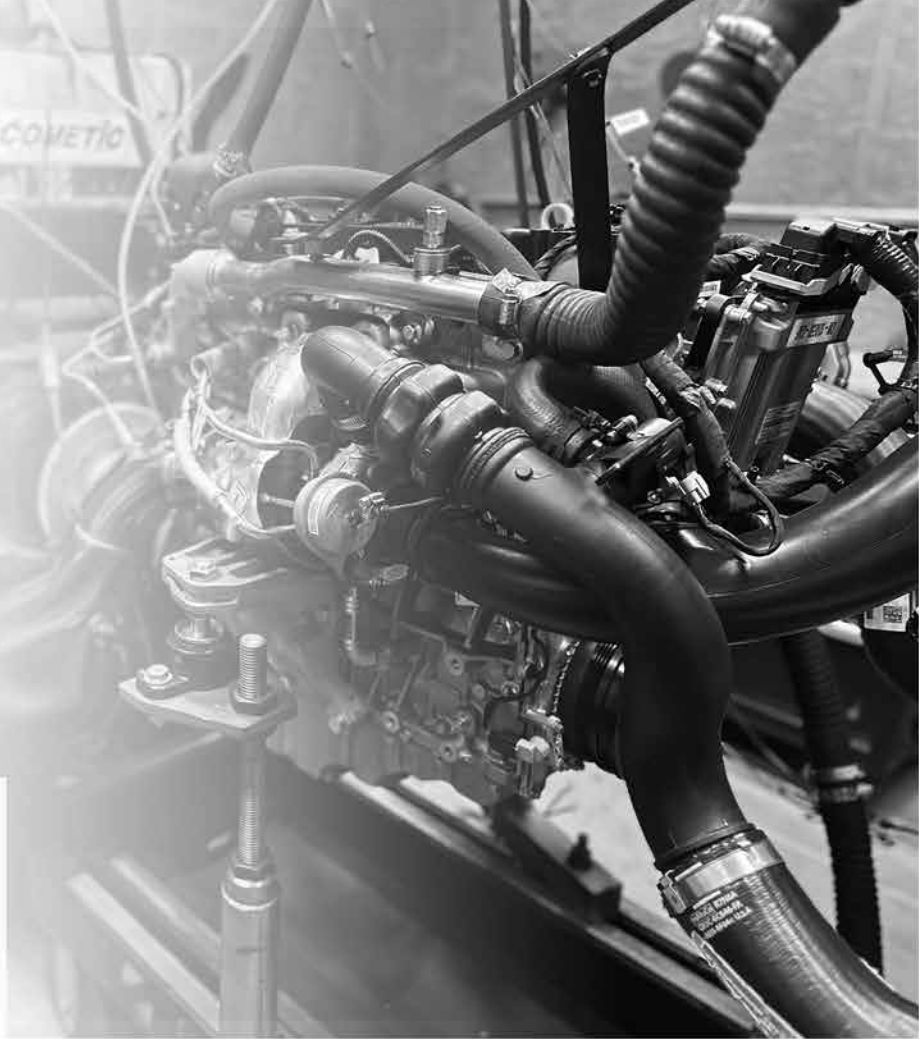
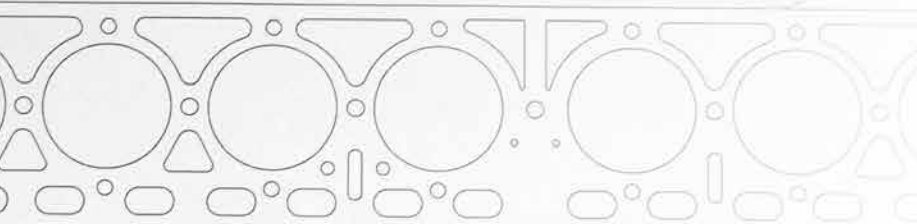

Custom Gaskets

Need to change a gasket bore size, thickness or both? Do you need a complete gasket design? The process starts with a simple phone call.

Cometic's in-house technical sales team can accommodate virtually any engine configuration, from naturally aspirated to the most exotic turbo or nitrous injected engines. Our commitment is to provide innovative, quality gaskets while maximizing your engine's power and performance. When customization is the only option, Cometic delivers!

How does Cometic do it? The process starts and ends under one roof in Concord, Ohio. Once our technical sales team understands your needs, design engineers draw the gasket with state-of-the-art software, and then it is off to manufacturing. Your gasket is engineered from the highest quality materials before being shipped. If special tooling is required, Cometic always provides a pre-production estimate for approval.

The passion for racing runs deep with our technical sales and engineering teams. We understand the importance of perfection in your next engine build because we're all high-performance aficionados!



OEM Production Gaskets

Cometic is your one source for OEM gaskets, from prototyping to full production.

We currently develop sealing solutions in nearly every environment for customers in the automotive, marine, powersports, industrial, and stationary power industries. Prototyping is essential and economical. Our in-house tool and die shop offers custom tooling options and quick turnaround. Not only are we ISO 9001:2015 Certified, but we have stamping, laser cutting, rubber-injection molding and 5-axis machining capabilities.

Flexibility and communication are key. Cometic understands there are countless variables in determining design, volume, and production forecasts. We are accustomed to working in dynamic environments and maintain the existing knowledge base and part awareness during the transition from the early stages of development through production, without the hassle of changing suppliers. Inventory turns are essential. We can work together for a delivery solution that best fits your inventory level and cash flow needs.



Partner Relationships

Cometic's gaskets are the industry standard for championship-winning teams and engine builders across multiple disciplines of both professional and amateur motorsports. Since its inception in 1989, Cometic has built relationships with the most reputable engine builders in the industry. Those relationships create the foundation on which Cometic's gaskets are engineered, validated and manufactured for everyday use, or in the most competitive and demanding environments.





Partners



Cometic Technology

FAQ	1
Cometic Head Gasket Technology.....	2
Cometic Material Offerings	3 & 4
Retail Line.....	5 & 6
StreetPro/Diesel Feature.....	7
ProPack.....	8

Miscellaneous Gaskets & Accessories

Timing Cover Sets	9
2PC Rear Main Seals	9
ATI Damper Re-Build Viton O-Rings.....	9
Engine Crankshaft Seals	10
Transmission Gaskets	10
Turbo Gaskets.....	10
Carburetor Gaskets.....	11
Differential Gaskets.....	11
Valve Cover Gaskets & Sets.....	12
Valve Stem Seals	13 & 14

Gaskets - Domestic

MAKE	PAGE
AMC	15
BUICK/GM	15
CADILLAC.....	17
CHEVROLET/GM	17
CHRYSLER/DODGE.....	37
CUMMINS.....	53
FORD.....	58
OLDSMOBILE/GM	82
PONTIAC/GM.....	83

Gaskets - Import

MAKE	PAGE
AUSTIN.....	85
BMW	85
COVENTRY CLIMAX.....	91
FERRARI.....	92
FIAT/LANCIA	92
FORD/LOTUS	92
GM.....	97
HOLDEN.....	98
HONDA/ACURA.....	98
HYUNDAI.....	112
JAGUAR.....	113
MAZDA.....	117
MERCEDES-BENZ	120
MG.....	120
MINI	121
MITSUBISHI.....	121
NISSAN.....	125

Import Gaskets continued to the right

Gaskets - Import (continued)

MAKE	PAGE
PEUGEOT/CITROËN	140
PORSCHE.....	141
RENAULT	143
ROVER.....	143
SAAB.....	144
SUBARU.....	144
TOYOTA	157
TRIUMPH	168
TVR.....	168
VAUXHALL/OPEL	169
VOLKSWAGEN/AUDI.....	169
VOLVO	172

Street Pro Kits

Cometic® StreetPro Kits are geared toward the street rodder who is looking to purchase a kit with all the necessary gaskets and seals needed for your rebuild.

Top & Bottom End Gasket Kits

MAKE	PAGE
BMW	85, 87
BUICK/GM	17
CHEVROLET/GM.....	20, 22, 26, 29, 30, 32, 33
CHRYSLER/DODGE.....	37, 38, 42, 43, 44, 46, 49, 50, 51
FORD.....	60, 61, 64, 66, 67, 70, 72, 76, 77
FORD/LOTUS	95, 96
HONDA/ACURA.....	100, 101, 102, 103, 104, 105, 106, 109
MAZDA.....	117, 119
MITSUBISHI.....	122, 123, 124
NISSAN.....	126, 127, 128, 129, 130, 131, 132, 133, 135, 136, 137
OLDSMOBILE/GM	83
PONTIAC/GM.....	84
SUBARU.....	147, 148, 149, 150, 152, 153, 154, 155
TOYOTA	158, 160, 161, 162, 164, 165

Top & Bottom End Gasket Kits - DIESEL

MAKE	PAGE
CHEVROLET/GM DURAMAX	36
DODGE CUMMINS.....	54, 55, 56, 57, 58
FORD POWERSTROKE	79, 80, 81, 82

Fel-Pro to Cometic Cross Reference

Fel-Pro to Cometic Cross Reference	173 & 174
--	-----------

NOTE: All pricing in this catalog is subject to change

MLS HEAD GASKETS

Q: CAN MLS HEAD GASKETS BE USED WITH ENGINES SETUP WITH O-RINGS OR RECEIVER GROOVES AROUND THE CYLINDER BORES?

A: No. MLS head gaskets require smooth, flat and true head and deck surfaces to seal. Most of the time with o-ring setups the wire and groove fall where our gasket's combustion seal is located; therefore, the wire will hold the gasket and not allow proper compression while the receiver grooves allow combustion gases to escape.

MLS HEAD GASKET INSTALLATION

Q: WHY DOES COMETIC RECOMMEND MLS GASKETS TO BE INSTALLED DRY?

A: Cometic Multi-Layer Steel (MLS) head gaskets go on dry because they are coated with a sealant. Each MLS head gasket is coated with a .001" thick proprietary coating that is bonded to the outer stainless steel layers. Adding an additional sealer can hinder the performance of an MLS head gasket.

TORQUE RECOMMENDATION

Q: WHAT HEAD BOLT/STUD TORQUE DO YOU RECOMMEND WHEN USING AN MLS GASKET?

A: When using MLS head gaskets always refer to the manufacturer of the fastener to determine accurate torque values. Appropriate torque is critical when installing new gaskets of any kind.

SURFACE FINISHING

Q: WHAT SURFACE FINISH IS REQUIRED TO US AN MLS HEAD GASKET?

A: A surface finish of 50 RA (roughness average) or finer, is recommended for a proper gasket seal. Anything rougher may conflict with the gasket design.

CUSTOM GASKETS

Q: CAN I ORDER HEAD GASKETS WITH A DIFFERENT THICKNESS AND/OR BORE SIZE THAN YOU HAVE IN YOUR CATALOG?

A: Cometic offers a wide range of options tailored to your specific application. For assistance, call our technical support line at 440-354-0777.

GASKETS AVAILABLE

Q: DOES COMETIC OFFER MORE THAN JUST HEAD GASKETS?

A: Absolutely! Cometic has the capabilities to make every gasket and seal needed to overhaul nearly any type of engine. We offer Rubber Molded Valve Cover Gaskets, Intake, Exhaust, Timing Cover, Oil Pan, Rear Main Seals, Valve Stem Seals, Carburetor Gaskets, and much more!

NEED IT CUSTOM?

Cometic's in-house Technical Sales Team understands your needs, working directly with our design engineers to ensure the gasket is drawn with state-of-the-art software and manufactured with the best materials, utilizing the most current and efficient manufacturing processes.

MLS | Multi-Layer Steel (Fully Embossed)

MLS technology features fully embossed active combustion seals located on the outer layers of the gasket. Precise embossments for critical sealing around water and oil passages are also formed on the outer layers. These are combined with Cometic's proprietary coated and uncoated stainless-steel layers to deliver exceptional sealing performance while reducing the required clamp load and minimizing bore distortion.

Optional shim layers can be added to tailor the overall gasket thickness to specific engine requirements.

AVAILABLE THICKNESSES*

(3-LAYER):

.023", .030", .036", .040", .045", .051"

(5-LAYER):

.050", .056", .060", .066", .070", .075", .080", .086", .092", .098", .120", .140"

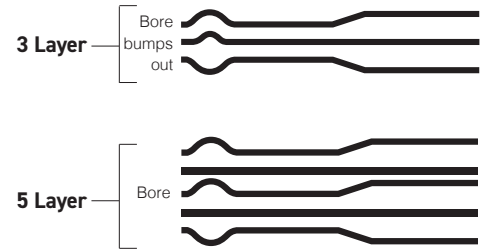

HP | High Performance Shim

HP Shim technology places active combustion seal embossments and precision water/oil sealing embossments on the outer layers. Designed primarily for open-deck engine platforms, HP technology incorporates a dedicated shim layer directly beneath the combustion seal embossment (unlike the offset styles seen in MLX or DST technologies).

This strategically placed shim layer, is engineered with precise thickness and width, that amplifies stress concentration around the combustion chamber to reduce distortion and deliver a dependable seal under demanding conditions.

AVAILABLE THICKNESSES*

(3-LAYER):

Ranges from .024" - .036"

(4-LAYER):

Ranges from .038" - .054"

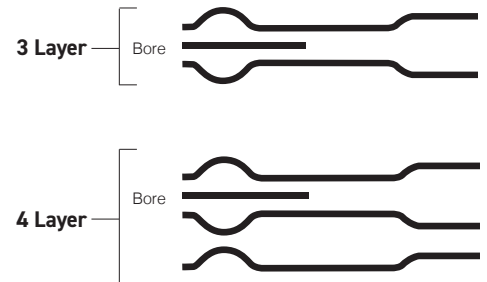

MLX | Multi-Layer Xtreme

MLX technology builds upon the MLS platform by incorporating a center stainless steel layer that is precision-folded. This "stopper" design improves clamp and provides local stress and sealing integrity around the combustion chamber without increasing bore distortion.

Precision embossments on the outer layers provide sealing for oil and coolant passages, ensuring all critical systems are reliably isolated.

AVAILABLE THICKNESSES*

(3-LAYER):

Ranges from .028" - .032"

(4-LAYER):

Ranges from .038" - .044"

(5-LAYER):

Ranges from .052" - .068"

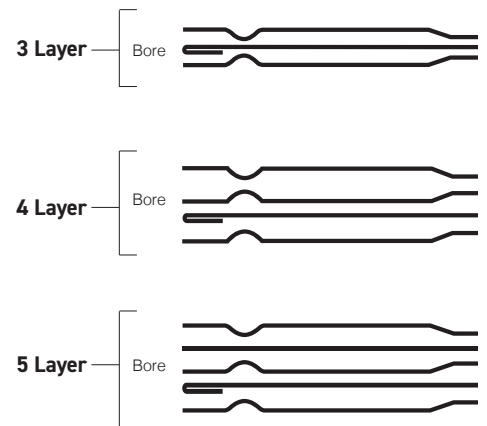

NEW!

DST | Dual Stopper Technology

DST is the next evolution of Cometic's proven Multi-Layer Steel and MLX Stopper designs. DST combines dual integrated, precision-folded stainless steel stopper layers with our embossed, proprietary-coated sealing layers. This construction delivers a uniform, evenly distributed clamping force across both the cylinder head and block combustion seal, significantly reducing bore distortion and enhancing overall sealing reliability.

DST gaskets are engineered as a direct bolt-on solution, eliminating the need for additional head machining, grooving, or o-ringing typically required in forced induction extreme performance applications.

AVAILABLE THICKNESSES*

.063", .071"

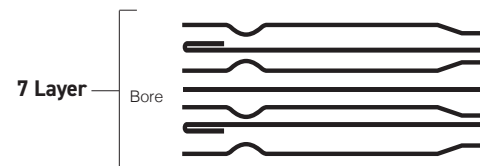

*NOTE: Not all thicknesses are available for every application.

MP

A high-quality synthetic material engineered for superior resistance to oil, fuel, ozone, and weathering. It offers excellent low flange pressure sealability and exceptional bolt torque retention. MP performs exceptionally well where chemical resistance and long-term sealing performance are critical.

RECOMMENDED USE:

- Carburetor Flange Gasket
- Metering Block
- Fuel Cell Gasket

*THICKNESS:

.062"

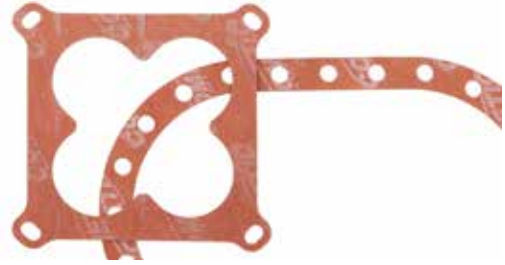

HTG

Features a metal-reinforced sealing material designed to seal irregular-surfaced flanges with reliability and resilience. Layered construction, a steel backing for strength, a graphite facing for high-temperature resistance, and a compressible fiber core for conformability. This robust combination delivers superior sealing performance at temperatures up to 1400°F.

RECOMMENDED USE:

- Exhaust Gaskets
- Turbo Gaskets

*THICKNESS:

.094"



RC

Consists of a 75-durometer NBR (nitrile butadiene rubber) coating applied to 1010 1/4 hard carbon steel. The NBR layer offers excellent resistance to oils, fuels, and coolants, while the steel core provides structural strength and dimensional stability.

RECOMMENDED USE:

- Differential Gaskets
- Base & Engine Case Gaskets

*THICKNESS:

.010" .012" .014" .016"
.020" .030"



Copper

Made from C110 copper, the purest form of oxygen-free copper, offers excellent corrosion resistance, superior ductility, and high thermal conductivity. It also resists embrittlement under heat. Cometic utilizes 99.9% pure copper, precision-tested for flatness to provide the most reliable seal between the cylinder head and engine block. For optimal performance, O-ringing is recommended.

RECOMMENDED USE:

- Head Gaskets
- Base Gaskets
- Exhaust Gaskets

*THICKNESS:

.005" .010" .016" .020" .032"
.043" .050" .063" .094"



Armor Clad

Featuring a high-temperature, high-performance fiber core, clad-style laminated with carbon steel layers on both sides. This construction delivers exceptional strength, thermal resistance, durability and is temperature rated up to 1,600° F.

RECOMMENDED USE:

- Exhaust Gasket
- Turbo Gasket

*THICKNESS:

.042" .064"



Cork

With a Shore A hardness of 50–65, it provides a balanced mix of softness and durability for a reliable seal under moderate pressure.

RECOMMENDED USE:

- Valve Cover Gaskets
- Oil Pan
- Timing Cover Gaskets
- Low-Torque Applications

*THICKNESS:

.031" .094" .125" .156"
.188" .250"



***NOTE: Not all thicknesses are available for every application.**

HTS

Featuring a high-strength, fiber-reinforced sealing material designed for demanding thermal and mechanical environments. It features a 75% graphite and Kevlar fiber blend, mechanically bonded to a perforated stainless steel core for enhanced structural integrity. Ideal for high-temperature sealing applications, with a short-duration maximum temperature rating of 760°C (1400°F).

RECOMMENDED USE:

- Intake Gaskets
- Exhaust Gaskets
- Turbo Gaskets

*THICKNESS:

.060"



Fiber

Fully cured nitrile butadiene rubber binder for maximum fluid resistance. It has excellent sealability in a variety of environments and flange conditions. Robust chemical resistance suitable for sealing oil, coolant, fuel, and is designed to withstand maximum temperatures up to 290°C (550°F).

RECOMMENDED USE:

- Intake Gasket
- Oil Pan Gasket
- Engine Case Gaskets
- Water Pump/Thermostat
- Valve Cover Gasket

*THICKNESS:

.012" .015" .020" .031" .039"
.047" .062" .080" .094" .125" .188"



AFM

A chemically blown, compounded nitrile synthetic rubber bonded to a durable aluminum core. Engineered for reliable sealing performance, it offers excellent temperature resistance exceeding 205°F. AFM stands out with an impressive 85% recovery and strong torque retention, ensuring consistent sealing without the need for additional sealants or re-torquing.

RECOMMENDED USE:

- Engine Case Gaskets
- Intake Gaskets
- Oil Pan/Pump Gaskets

*THICKNESS:

.018" .032" .060" .075"



CFM-20

Tanged and galvanized steel core. An asbestos-free soft material compound containing aramid fibers, inorganic fillers, and high-grade binder elastomers is applied to both sides of the core.

RECOMMENDED USE:

- Head Gasket
- Intake Gaskets
- Plenum Gaskets
- Base Gaskets

*THICKNESS:

.043" .059"



TNG Fiber

High-density material with a fully cured nitrile binder. Excellent resistance to fuel, oil, and has good tensile strength. Intended for high flange pressures and short-run duration max temperatures up to 350C (650F).

RECOMMENDED USE:

- Intake Gasket
- Carburetor Gasket
- Supercharger Gasket

*THICKNESS:

.060" .062"



**NOTE: Not all thicknesses are available for every application.*



Description	Part No.	Retail
Chevrolet Gen-1 Small Block V8 .094" HTG Exhaust Manifold Gasket Set, 1.625" Round Ports	C5893HTG	\$37.77
Chevrolet Gen-1 Small Block V8 .094" HTG Exhaust Manifold Gasket Set, 1.480" x 1.450" Square Ports	C15190HTG	\$36.66
Holley 4 Barrel .060" Fiber Carburetor Gasket, Open Plenum	C5263FC	\$9.43
Intake Manifold Bolts 3/8 - 16 x 1", Grade 8 Zinc Plated	CF1010	\$31.10
26" x 10" x 1/32" Fiber Gasket Making Material, Includes Cutting Tool	C15385	\$13.88
Header Bolts 3/8 - 16 x 1", Grade 5 Black Oxide Finish With Compact Hex Head	CF1012	\$18.88
GM Gen-3/4 Small Block V8 MLS Exhaust Manifold Gasket Set	C15547	\$55.54
Chevrolet L82/L83/L84/L86/L87/L88/L8T/LT1/LT4/LT5 Gen-5 Small Block V8 .021" MLS Exhaust Manifold Gasket Set	C5020-021	\$57.77
Header Bolts 3/8 - 16 3/4", Grade 5 Black Oxide Finish With Hex and Socket Head	CF1009	\$22.21
Chevrolet Gen-1 Small Block V8 .060" HTS Exhaust Manifold Gasket Set, 1.550" x 1.450" Square Ports	C15189HTS	\$29.99
Exhaust Header Collector Gasket Set .060" Copper, 3.0" Diameter Port, 3.875" Bolt Circle, Set	C5907C	\$24.43
5/16" Air Cleaner Stud, Includes Stud, Wingnut, and Stud Adapter	CF1014	\$11.66
Ford/GM 1986+ Fuel Injector O-Ring, 8 Pack	C15383	\$11.10
Chevrolet Gen-1 Small Block V8 .060" HTS Exhaust Manifold Gasket Set, 1.625" Round Ports	C5893HTS	\$31.10
Carburetor Studs 2 1/2" Zinc Plated, Set of 4 With Washers and Nuts	CF1002	\$13.32
Carburetor Studs 1 1/2" Zinc Plated, Set of 4 With Washers and Nuts	CF1000	\$11.10
Chevrolet Gen-1 Small Block V8 .060" Fiber With Silicone Bead Intake Manifold Gasket Kit, 2.00" x 1.25" Port, With Blocked Exhaust Crossovers	C15178FCS	\$27.77
Holley 2300/4150/4160/4500 Carburetor Float Bowl Cover Gasket Set	C15386	\$14.43
Ford 5.0L Gen-1/2/3 Coyote Modular V8 .030 MLS Exhaust Manifold Gasket Set	C5392-030	\$55.54
Chevrolet Mark-IV; GM Gen-V/VI Big Block V8 .060" HTS Exhaust Manifold Gasket Set	C5897HTS	\$31.10
Chevrolet Gen-1 Small Block V8 .188" Molded Rubber Valve Cover Gasket Set, 18/23 Degree Heads	C5973PR	\$25.54
Header Bolts M8 - 1.25 x 25mm, Grade 5 Carbon Steel Comes With Compact Head and Black Oxide Finish	CF1013	\$14.43
Flexplate Bolts 7/16 - 20 x 11/16", Grade 8 With Black Oxide Finish and Lock Washers	CF1007	\$20.54

See page 6 for additional gaskets

Description	Part No.	Retail
GM/Ford/Chrysler Aluminum Carrier With Rubber Insert Water Outlet Gasket, 2 Bolt	C15191	\$27.21
Exhaust Header Collector Gasket .043" Copper, 2.5" Diameter Port, 3.5" Bolt Circle, Set	C15187C	\$24.99
Carburetor Studs 2" Zinc Plated, Set of 4 With Washers and Nuts	CF1001	\$12.21
Intake Manifold Bolts 3/8 - 16 x 1", Grade 5 Zinc Plated	CF1011	\$14.43
Exhaust Header Collector Gasket .040" Aluminum, 3.0" Diameter Port, 3.875" Bolt Circle, Set	C5907A	\$24.43
26" x 10" x 1/16" Cork/Rubber Gasket Making Material, Includes Cutting Tool	C15384	\$13.88
Chevrolet Gen-1 Small Block V8 .188" Fiber Valve Cover Gasket Set, 18 Degree Heads, Brodix 12 Series Head	C5537LF	\$22.21
Harmonic Balancer Bolt Kit 7/16 - 20 x 2.25", Grade 8 Bolt With Tall Hex Head and Extra Thick Ground Washer With Zinc Dichromate Gold Finish	CF1008	\$13.32
Holley 4 BBL .060" Fiber Carburetor Mounting Gasket, 4 Hole, 1.750" Holes	C5262FC	\$8.32
Torque Converter Bolts 3/8 - 24 x 5/8", Grade 8 Black Oxide Finish With Nuts, Fits GM TH350 and Powerglide Transmissions	CF1003	\$16.66
Carburetor Studs 2" Black Oxide Finish, With Bullet Tip	CF1005	\$15.54
GM LS1 V8 .060" HT Exhaust Header Gasket Set	C15568HT	\$32.21
Exhaust Header Collector Gasket Set .060" HTS, 3.0" Diameter Port, 3.875" Bolt Circle, Set	C5907HTS	\$18.88
Exhaust Header Collector Gasket Set .060" HTS, 2.5" Diameter Port, 3.5" Bolt Circle, Set	C15187HTS	\$19.43
Rochester Quadrajet 4 BBL .060" Fiber Carburetor Mounting Gasket, Spread Bore	C15183FC	\$8.32
Exhaust Header Collector Gasket .040" Aluminum, 2.5" Diameter Port, 3.5" Bolt Circle, Set	C15187A	\$23.32
Carter AFB .060" Fiber Carburetor Mounting Gasket, 1.490" Ports, Square Bore	C15181FC	\$8.88
Ford Windsor V8 .060" HTS Exhaust Manifold Gasket Set	C5898HTS	\$26.77
Holley 2 BBL .060" Fiber Carburetor Mounting Gasket, Open Center	C15184FC	\$8.32
Replacement Water Neck O-Rings Fits #2660/2661/2663/2667/9845	C15192	\$9.99

Sheet Materials



C15180F



C15543



C15384

Description*	Part No.	Retail
10" X 10" X .060" HTS	C15180HTS	\$17.70
24" X 6" X .060" FC	C15346FC	\$15.35
24" X 6" X .060" HTS	C15346HTS	\$27.15
24" X 6" X .060" TNG	C15346TNG	\$21.97
36" X 9" X .031" Fiber	C15354F	\$17.66
12" X 12" X .060" TNG	C15358TNG	\$15.35
10" X 26" X 1/16" Cork/Rubber (w/Cutting Tool)	C15384	\$14.57
10" X 26" X 1/32" Fiber (w/Cutting Tool)	C15385	\$14.57



C15385

*NOTE: See pages 3 & 4 for detailed material descriptions.



STREETpro

by Cometic Gasket

Cometic's StreetPro gasket kits are built to meet or exceed OE standards engineered for rebuilders who demand reliability and convenience in one complete package. Each kit includes all the essential gaskets and seals needed for a successful engine rebuild.

Available for a wide range of applications, including: Domestic, Import, and Diesel Engines.

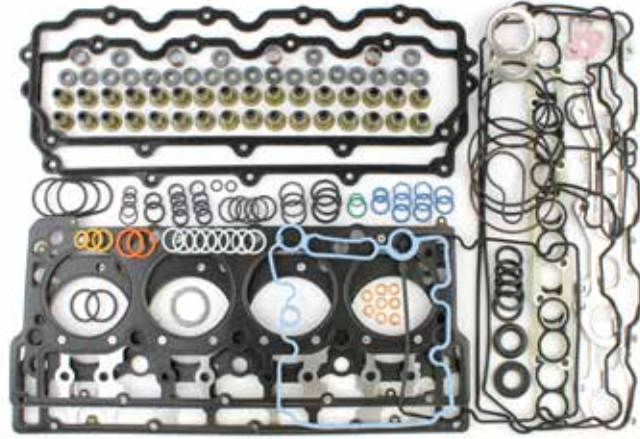

Top End Diesel Gasket ProKit

FEATURED:

Cometic StreetPro Diesel Gasket Kits

Top End ProKits

Description	Part No.	Retail
Cummins 3.9L 4BT Top End Gasket Kit, 4.100" Bore, .061" MLX Cylinder Head Gasket	PRO3000T	\$246.02
Cummins 5.9L 6BT Top End Gasket Kit, 4.100" Bore, .061" MLX Cylinder Head Gasket	PRO3001T	\$432.74
Cummins 5.9L ISB Top End Gasket Kit, 4.100" Bore, .061" MLX Cylinder Head Gasket	PRO3002T	\$469.84
Cummins 5.9L ISB CR Top End Gasket Kit, 4.100" Bore, .061" MLX Cylinder Head Gasket	PRO3003T	\$502.00
Cummins 2007-2018 6.7L ISB Top End Gasket Kit, 4.312" Bore, .052" MLX Cylinder Head Gasket	PRO3004T	\$502.00
Ford 6.0L Power Stroke Top End Gasket Kit, 96mm Bore, .062" MLX Cylinder Head Gasket, 18mm Dowels	PRO3005T	\$910.07
Ford 6.0L Power Stroke Top End Gasket Kit, 96mm Bore, .062" MLX Cylinder Head Gasket, 20mm Dowels	PRO3006T	\$910.07
Ford 6.4L Power Stroke Top End Gasket Kit, 103mm Bore, .062" MLX Cylinder Head Gasket	PRO3007T	\$910.07
GM LB7 Duramax Top End Gasket Kit, 4.100" Bore, .040" MLS Cylinder Head Gasket	PRO3008T	\$539.09
GM LLY/LBZ Duramax Top End Gasket Kit, 4.100" Bore, .040" MLS Cylinder Head Gasket	PRO3009T	\$662.75
Ford 7.3L Power Stroke Top End Gasket Kit, 4.140" Bore, .066" MLS Cylinder Head Gasket, 1994-2003 VIN F	PRO3010T	\$520.55
GM LMM/LLY Duramax Top End Gasket Kit, 4.130" Bore, .047" MLX Cylinder Head Gasket	PRO3011T	\$653.79
GM LML/LGH Duramax Top End Gasket Kit, 4.130" Bore, .047" MLX Cylinder Head Gasket	PRO3012T	\$660.45

Bottom End ProKits

Description	Part No.	Retail
Cummins 3.9L 4BT Bottom End Gasket Kit	PRO3000B	\$246.02
Cummins 5.9L 6BT Bottom End Gasket Kit	PRO3001B	\$279.41
Cummins 5.9L ISB Bottom End Gasket Kit	PRO3002B	\$222.00
Cummins 2007-2018 6.7L ISB Bottom End Gasket Kit	PRO3004B	\$241.07
Ford 6.0L Power Stroke Bottom End Gasket Kit	PRO3005B	\$169.35
Ford 6.4L Power Stroke Bottom End Gasket Kit	PRO3007B	\$222.52
GM LB7/LLY/LBZ Duramax Bottom End Gasket Set	PRO3008B	\$205.22
Ford 7.3L Power Stroke Bottom End Gasket Kit, 1994-2003, VIN F	PRO3010B	\$230.88
GM LMM/LGH Duramax Bottom End Gasket Set	PRO3011B	\$214.77
GM LML Duramax Bottom End Gasket Kit	PRO3012B	\$220.89
Ford 6.7L Power Stroke Bottom End Gasket Kit	PRO3013B	\$220.89



Bottom End Diesel Gasket ProKit

THERE'S MORE!

Diesel, Domestic, and Import gasket kits can also be found under their respective applications throughout this catalog.



- Convenient bulk packaged gaskets for the Professional Engine Builder
- Available in 10 & 20 packs
- Significant cost savings over individually purchased gaskets

Pro Pack Bulk Packaged Gaskets

Description	Pkg. Qty.	Part No.	Retail
Chrysler/Ford/GM Fuel Pump Gasket .031" Fiber, 4 Bolt	10 pack	CP15012	\$12.35
Holley 4500 Dominator Carb Gaskets .060" Fiber, Open Plenum	10 Pack	CP15238	\$33.06
Holley Float bowl Gasket, .062" MP	20 Pack	CP15241	\$61.73
Holley Metering Block Gaskets .062" MP, 2 Circuit	20 Pack	CP15242	\$61.73
Holley Metering Block Gaskets .062" MP, 3 Circuit	20 Pack	CP15243	\$61.73
GM LS Gen-3/4 Timing Cover Gasket	10 Pack	CP15280	\$194.63
GM LS Gen-3/4 Rear Main Seal Cover Gasket	10 Pack	CP15281	\$257.57
Chevy Gen-1 Small Block V8 Timing Cover Seal	10 Pack	CP15282	\$50.11
Chevy Gen-4/5/6 Big Block V8 Timing Cover Seal	10 Pack	CP15283	\$61.76
Chevy Gen-1 Small Block V8 Timing Cover Gasket .031" Fiber	10 Pack	CP15615	\$50.70
Ford 302/351W V8 Intake Manifold Gasket .060" Fiber 1.200" X 2.00" Port	20 Pack	CP15648	\$178.59
Ford 302/351W V8 Intake Manifold Gasket .060" Fiber 1.400" X 2.250" Port	20 Pack	CP15649	\$178.59
Ford 302/351W V8 Exhaust Manifold Gasket .060" HTS 1.668" X 1.617" Port TFS R Head Dual Pattern	20 Pack	CP15650	\$192.94
Ford 302/351W V8 Exhaust Manifold Gasket .060" HTS 1.422" X 1.625" Port Dart/TFS Heads Dual Pattern	20 Pack	CP15651	\$209.48
Ford 302/351W/460 V8 Timing Cover Seal	10 Pack	CP15652	\$75.76
Chrysler B/RB, Gen-2 Hemi V8 Timing Cover Gasket .031 Fiber	10 Pack	CP5062	\$61.73
Chevy Gen-1 Small Block V8 Header Gasket .060" HTS 1.810", Round Port Hooker/Stahl Pattern	20 Pack	CP5126	\$208.36
GM LS Gen-3/4 Small Block V8 Oil Pan Gasket Except LS1/LS6 Corvette	10 Pack	CP5173	\$339.15
Chevy Gen-4 Big Block V8 .060" HTS Exhaust Manifold Gasket, 2.250" Round Port	20 Pack	CP5251	\$220.49
Holley 4 Barrel Carb Gasket .060" Fiber, Open Plenum	10 Pack	CP5263	\$31.96
Ford 302/351W V8 Timing Cover Gasket .031" Fiber	10 Pack	CP5276	\$55.11
Chevy Gen-1 Small Block V8 .031" Fiber Water Pump Mounting Gasket	20 Pack	CP5299	\$30.86
Chevy Gen-4/5 Big Block V8 Timing Cover Gasket .031" Fiber	10 Pack	CP5345	\$55.11
Chevy Gen-4 Big Block V8 Water Pump Mounting Gasket .031" Fiber	20 Pack	CP5347	\$30.86
Chrysler/Ford/GM Fuel Pump Gaskets .031" Fiber, 2 Bolt	10 Pack	CP5389	\$11.91
Chevy Gen-1 Small Block V8 Intake Manifold Gasket .060" Fiber, 1.280" X 2.170" Port, 23 Degree Heads	20 Pack	CP5528	\$176.39
Chevy Gen-1 Small Block V8 Intake Manifold Gasket .060" Fiber, 1.350" X 2.250" Port, 18 Degree Heads	20 Pack	CP5541	\$176.39
Chevy Gen-1 Small Block V8 Intake Manifold Gasket .060" Fiber, 1.240" X 2.100" Port, 23 Degree Heads	20 Pack	CP5542	\$176.39
Chevy Gen-1 Small Block V8 Intake Manifold Gasket .060" Fiber, 1.240" X 1.970" Port, 23 Degree Heads	20 Pack	CP5544	\$176.39
Chrysler B/RB, Gen-2 Hemi V8 Water Pump Housing Gasket .031" Fiber	10 Pack	CP5602	\$22.04
Chrysler B/RB, Gen-2 Hemi V8 Water Pump Gasket .031" Fiber	20 Pack	CP5615	\$39.03
Chevy Gen-4 Big Block V8 Intake Manifold Gasket .060" Fiber, 1.750" X 2.500" Rectangular Port	20 Pack	CP5649	\$176.39
Ford 302/351W V8 Intake Manifold Gasket .060" Fiber 1.280" X 2.115" Port	20 Pack	CP5652	\$178.59
GM LS Gen-3/4 Small Block V8 .060" HTS Exhaust Manifold Gasket	20 Pack	CP5818	\$199.54
Ford 302/351W V8 Exhaust Manifold Gasket .060" HTS 1.250" X 1.480" Port	20 Pack	CP5898	\$192.94

Description	Part No.	Retail
AMC 290-401 V8 66-88	C5046	\$19.47
AMC 4/6 Cyl 2.5/3.8/4.0/4.2L 65-06	C5047	\$20.58
Buick V6/Small V8 66-87 (Rope Seal)	C5048	\$27.46
Buick V6/Small V8 66-87 (Radial Seal)	C5049	\$20.58
Buick 400/430/455 V8 67-74	C5050	\$19.47
GM Small Block V8/V6 75-95 (Thick Front Seal)	C5051	\$19.47
GM Small Block V8 57-74 (Thin Front Seal)	C5052	\$19.47
GM 4/6 Cyl 151/230/250/192 63-89	C5053	\$19.47
GM Small Block LT1 V8 92-94	C5054	\$33.80
GM Small Block LT1 V8 94-97	C5055	\$25.98
GM Small Block LS V8 97-Up	C5056	\$45.45
GM Big Block V8 65-95	C5057	\$21.78
GM Big Block V8 96-00	C5058	\$19.47
Chrysler Magnum V6/V8 92-96	C5059	\$25.98
Chrysler Magnum V6/V8 97-03	C5060	\$25.98
Chrysler LA Small Block V6/V8 64-91	C5061	\$32.46
Chrysler 5.7/6.1/6.2/6.4L Hemi 03-UP	C5202	\$48.06
Chrysler Wedge/426 Hemi V8 58-79	C5062	\$32.46
Chrysler Early Hemi V8 55-59	C5063	\$34.31
Ford Small Block V8 62-78	C5064	\$28.58
Ford Small Block V8 79-97	C5065	\$28.58
Ford 351C/351M/400 V8 70-81	C5066	\$25.98
Ford 352/360 FE V8 58-60	C5067	\$27.46
Ford 332-428 FE V8 61-71	C5068	\$25.98
Ford 429/460 Big Block 68-85	C5069	\$25.98
Olds 260-455 V8 64-90	C5070	\$27.46
Pontiac 265-455 V8 63-81	C5071	\$32.46



Rear Main Seals

2 Pc Viton Rear Main Seals

Description	Part No.	Retail
Buick W / Side Rails 196, 23, 252	C5707	\$22.14
Chevy 283-400	C5680	\$29.75
Chevy BB 396-454	C5682	\$35.65
Chrysler 273, 318, 340	C5683	\$38.73
Chrysler 360	C5684	\$43.00
Chrysler 361-440 & Hemi	C5686	\$40.69
Ford 289, 302	C5688	\$34.21
Ford 351C, 351M, 351W	C5689	\$36.26



ATI Damper Re-Build Viton O-Rings

Description	Part No.	Retail
6" Damper Rebuild Kit (3-Ring)	C5393	\$97.46
7" Damper Rebuild Kit (3-Ring)	C5982-070	\$97.46
6" Damper Rebuild Kit (4-Ring)	C5632	\$121.83

Description	Signal Part No.	TTS Part No.	Part No.	Retail
JESEL Small Block Crank B/Drive F.C	86587	T-13527	C5376	\$89.73
JESEL Big Block Crank B/Drive F.C	86622	T-13553 Rev. B	C5377	\$77.73
JESEL (SEL 38000) Cam	86586	T-13561 Rev. B	C5435	\$81.12
Aluminum GM Sprint 400 Main	86410	T-13675	C5672	\$105.96
Chevy Small Block Rear Split Seal	86625	T-13675-DL	C5379	\$95.05
Chevy Big Block Rear Single Split Seal	86665	T-13676-SS	C15560	\$91.78
Ford Rear Crankseal W/302 Crank	85742	T-13584	C5384	\$124.53
Ford Rear Crankseal 302	13610	T-13610	C5385	\$98.25
Ford Front Crankseal 302 & 351	85338	T-13690	C5386	\$90.91
Ford R.R. Crankseal 351	85339	T-14053	C5391	\$87.82



Transmission Gaskets

Why trust your expensive transmission to some flimsy paper gasket? Keep your transmission fluid and gear lube where it belongs with our Aluminum Foamet Material (AFM) Gaskets. AFM consists of an aluminum core and features a foam rubber coating bonded to both sides. Ideal for sealing less than perfect surfaces and can be installed without the use of additional sealers!

Application	Material	Part No.	Retail
Dodge 727/46RE Pan	.060" AFM	C15246	\$21.20
Ford A4LD/4R44E/4R55E 1993-05	.060" AFM	C15247	\$21.20
Ford C-4/C-5 11 Bolt 1970-86	.060" AFM	C15248	\$21.20
Ford C-6 3 Speed 17 Bolt	.060" AFM	C15249	\$21.20
GM 4L80E 1991-10	.060" AFM	C15250	\$21.20
GM TH700-R4/4L60E 1982-03	.060" AFM	C15251	\$21.20
GM Powerglide 2Spd Trans Pan	.075" AFM	C15252	\$21.20
GM Turbo 400 Trans Pan	.075" AFM	C15253	\$21.20
GM Turbo 350 Pan Trans	.075" AFM	C15254	\$21.20
Muncie M21 Gasket Kit - No Seals	018" & .032" AFM	C15255	\$35.36
DOD/CHRY/AMC 904 Torqueflite	.060" AFM	C15469	\$21.20
Chry ZF 8HP90/8HP95 Transmission	.075" AFM	C15265	\$41.45
GM 6L80 Transmission Pan	.060" AFM	C15725	\$24.84
GM 8L90 Transmission Pan	.060" AFM	C15726	\$24.84
GM 10L80 Transmission Pan	.060" AFM	C15727	\$24.84

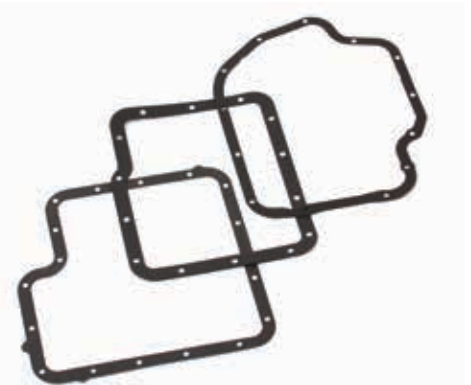

Turbo Gaskets

Manufactured from a high grade stainless steel, these turbocharge gaskets get the job done the first time! The embossed spring steel maintains a torque set and won't burn through or push out. Does not require additional sealers.

Application	Material	Part No.	Retail
Turbo Inlet Flange Gasket, T3/GT30R	.016" Stainless	C15585	\$14.32
Turbo Inlet Flange Gasket, T3 Divided	.016" Stainless	C15586	\$14.32
Turbo Inlet Flange Gasket, T4 Rectangular	.016" Stainless	C15584	\$14.32
Turbo Inlet Flange Gasket, T04 Divided	.016" Stainless	C15590	\$20.58
Turbo Inlet Flange Gasket, T25/T28/GT25	.016" Stainless	C15587	\$14.32
Turbo Inlet Flange Gasket, T06	.016" Stainless	C15589	\$14.32
Turbo Inlet Flange Gasket, T06 Divided	.016" Stainless	C15588	\$20.58
Turbo Inlet Flange Gasket, GT30R/GT35R/GT40R	.016" Stainless	C15591	\$14.32
Discharge Flange Gasket, GT Series 2.5"	.016" Stainless	C15596	\$14.32
Discharge Flange Gasket, GT Series 3"	.016" Stainless	C15595	\$20.58
Discharge Flange Gasket, GT32 6 Bolt	.016" Stainless	C15594	\$21.74
Discharge Flange Gasket, K03/K04 4 Bolt	.016" Stainless	C15593	\$20.58
Wastegate Flange Gasket, Tial Style	.016" Stainless	C15592	\$9.50
Subaru WRX Turbo To Up Pipe	.030" MLS	C5723-030	\$10.37
Subaru WRX Turbo To Downpipe	.030" MLS	C5736-030	\$10.37



Designed by engineers, validated by the winner's circle. Cometic carburetor gaskets are manufactured from performance grade materials that resist swelling from various types of fuel. Can be custom ordered to your exact specifications.

Application	Material	Part No.	Retail
Holley 2bbl Carb Open Plenum	.039" Fiber	C15184	\$8.25
Holley 2bbl Carb 2 Hole 1.750"	.047" Fiber	C5282	\$6.00
Holley 4150 4bbl Carb Open Plenum	.047" Fiber	C5263	\$6.57
Holley 4150 4bbl 4 Hole 1.750"	.047" Fiber	C5262	\$6.57
Holley 4500 4bbl Carb Open Plenum	.047" Fiber	C15238	\$9.92
Holley 4500 4bbl 4 Hole 2.000" Gasket	.047" Fiber	C15239	\$6.57
Holley 390 Cfm 4bbl Carb 4 Hole 1-19/32"	.047" Fiber	C5280	\$6.57
Carter Afb 4bbl Square Bore 4 Hole	.039" Fiber	C15181	\$8.25
Rochester Quadrajel 4bbl Spread Bore	.039" Fiber	C15183	\$8.25
Weber 48mm Carb	.047" Fiber	C15240	\$4.02
Holley Airhorn Carb	.060" Fiber	C5388	\$3.40
Holley Float Bowl	.062" MP	C15241	\$7.47
Holley 2 Circuit Metering Block	.062" MP	C15242	\$7.47
Carter Afb 4bbl Square Bore 4 Hole	.062" MP	C15243	\$7.47
Holley/Quik Fuel Power Valve	.062" MP	C15244	\$1.23

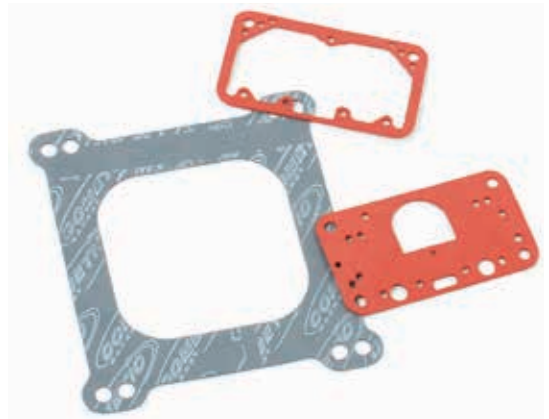

Differential Gaskets

Cometic Differential Gaskets are offered for the most popular differentials in the industry. Made from performance inspired materials and engineered to be the best sealing gasket you can find. Don't see what you are looking for? Simply contact Sales at 1-800-752-9850.

Application	Material	Part No.	Retail
Nissan Titan XD	.060" AFM	C14006-060	\$29.47
AMC 12 Bolt	.125" FIBER	C15212	\$13.08
Dana 25,27,30 10 Bolt	.032" AFM	C15213	\$9.78
Dana 35 10 Bolt	.060" AFM	C15214	\$10.54
Dana 44	.060" AFM	C15215	\$18.15
Dana 44/GM 8.75" Corvette/Viper	.032"AFM	C15216	\$7.35
Dana 60/70	.060" AFM	C15217	\$18.15
Dana 80 10 Bolt	.032" AFM	C15218	\$13.41
Dodge 7.25" 10 Bolt Front Axle	.032" AFM	C15219	\$11.49
Dodge 8.25" 10 Bolt Rear Axle	.032" AFM	C15220	\$9.63
Ford 10.5" 12 Bolt	.032"AFM	C15221	\$9.78
Ford 8" 10 Bolt	.032" AFM	C15222	\$8.49
Ford 8.8" 10 Bolt	.060" AFM	C15223	\$22.39
Ford 9" 10 Bolt	.032" AFM	C5848-032	\$22.39
Ford 9.75" 12 Bolt	.060" AFM	C15225	\$13.65
GM "O" Axle 12 Bolt Irregular	.060" AFM	C15226	\$11.50
GM 1/2 Ton 12 Bolt	.032"AFM	C15227	\$7.35
GM 12 Bolt	.060" AFM	C15228	\$11.50
GM 7.5" 10 Bolt Rear Axle	.032"AFM	C15229	\$9.19
GM 7.75" 9 Bolt Front Axle	.032" AFM	C15230	\$9.78
GM 8.5" 1/2 & 3/4 Ton 10 Bolt	.032"AFM	C15231	\$7.35
GM 8.5" 10 Bolt	.060"AFM	C15232	\$10.89
GM 9.5" 1/2 & 3/4 Ton 14 Bolt	.060"AFM	C15233	\$14.98
GM Truck 14 Bolt	.060"AFM	C15234	\$14.98
Legend Car 10 Bolt	032" AFM	C15235	\$16.25
Sprint Midget 10-Bolt Quick Change	.060" AFM	C15236	\$12.96
Winter Quick Change 10 Bolt	.060" AFM	C15237	\$10.11



Sport Compact

Application	Part No.	Retail
Ford Zetec 2.0L DOHC 1995-97 / Set	C4643	\$34.31
Ford Zetec 2.0L DOHC 1998-04 / Set	C4644	\$64.10
Ford Focus ST 2.0L/2.3L 2012-2018	C15445	\$42.55
Ford 2300 2.3L SOHC 1974-93 / Set	C4653	\$44.29
Honda D15B1/D15B2/D15B7/D16A6/D16A7 88-95 / Set	C4701	\$38.44
Honda B16A2/3, B17A1, & B18C1/C5 94-01 / Set	C4628	\$27.46
Honda D16B5 & D16Y5/7/8 96-00 / Set	C4665	\$27.46
Honda D16Z6 VTEC 92-95 / Set	C4655	\$43.05
Honda D16A1/D16A8/D16A9 86-89 / Set	C4706	\$38.44
Honda B18A1/B1 1990-01 / Set	C4679	\$50.12
Honda L15B7	C14111	\$24.96
Honda K20/K23/K24	C14012	\$16.96
Mazda B6ZE 1.6L 1989-93 / Set	C4781	\$27.46
Mazda MX-6 FS-DE 2.0L 91-97 / Set	C4788	\$34.31
Mitsubishi 6G72 DOHC 24V 3.0L 91-99 / Set	C4722	\$95.57
Mitsubishi 4G63/4G63T 2.0L 90-99 / Set	C4691	\$46.68
Mitsubishi 6G72 SOHC 24V 3.0L 88-96 / Set	C4713	\$72.71
Mitsu/Dodge 2.0L 420A/ECC 95-99 / Set	C15046	\$52.45
Nissan CA16DE/CA18DE/CA18DET 1987-1993 / Set	C4607	\$41.96
Nissan E13/E15/E16 1982-89 / Set	C4906	\$20.58
Nissan KA24DE-A 2.4L 1993-01 Fwd / Set	C4631	\$34.31
Nissan KA24DE 2.4L DOHC 1990-94 / Set	C4761	\$27.46
Nissan KA24DE 2.4L DOHC 1995-04 / Set	C4766	\$41.96
Nissan RB20/25/26 1988-02 / Set	C4552	\$41.19
Nissan SR16VE/SR20VE/SR20DE 97-02 Fwd / Set	C4730	\$48.06
Nissan SR20DE Fwd, SR20DET Awd 91-96 / Set	C4747	\$34.31
Nissan SR20DE/SR20DET S13 DOHC 88-93 Rwd / Set	C4753	\$25.98
Nissan SR20DE/SR20DET S14/S15 DOHC 94-98 Rwd / Set	C4755	\$25.98
Nissan VG30DE/VG30DETT 3.0L V6 90-99 / Set	C4773	\$34.31
Subaru EJ22E SOHC 90-96 / Set	C4871	\$48.95
Subaru EJ255 06-Up, EJ257 08-Up / Left	C4880	\$27.46
Subaru EJ255 06-Up, EJ257 08-Up / Right	C4881	\$27.46
Subaru EJ25D DOHC 96-99 / Set	C4873	\$114.22
Subaru WRX EJ205 02-05 / Right	C4863	\$54.00
Subaru WRX EJ205 02-05 / Left	C4864	\$38.44
Subaru EJ251 SOHC 1999-05 / Set	C4642	\$41.19
Subaru EJ257 DOHC 2004-07 / Left	C4928	\$27.46
Subaru EJ257 DOHC 2004-07 / Right	C4929	\$27.46
Toyota 20R/22R/22R-E 75-85 / Set	C4935	\$20.58
Toyota 2RZ-FE/3RZ-FE 4 Cyl 95-04 / Set	C4830	\$41.96
Toyota 4A-GE/4A-GEZ 1.6L 16-Valve 84-92 / Set	C4807	\$21.96
Toyota 5S-FE 2.2L 4 Cyl 90-97 / Set	C4820	\$31.57
Toyota Supra 2JZ-GE/2JZ-GTE 93-98 / Set	C4851	\$41.19
Toyota Supra 7M-GE/7M-GTE 86-92 / Set	C4838	\$27.46
Toyota 3S-GTE 1990-1995 / Set	C4608	\$45.32

Race inspired designs and materials ensure that these valve cover gaskets will perform well above the OE standard. Cometic valve cover gaskets surpass the quality and ability of typical cork or paper gaskets offered by other manufacturers. Withstands blowing out, over tightening, and high vacuum all at an affordable price.

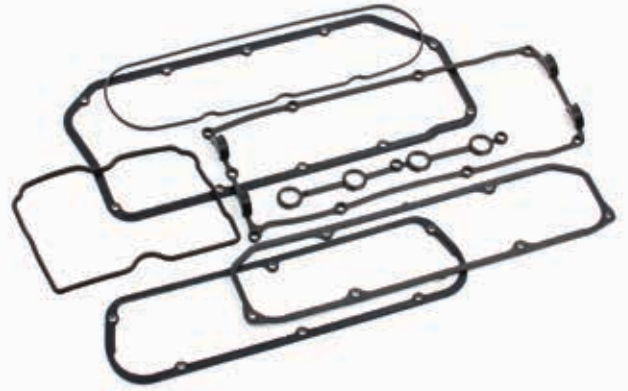

Diesel

Application	Part No.	Retail
Cummins 3.9L 4Bt 4Cyl Diesel / Set	C15056	\$25.98
Cummins 5.9L 24V Diesel 1998.5-02 / Set	C5614	\$174.83
Cummins 5.9L 12V Diesel 1992-98 / Set	C15066	\$45.45
Cummins 5.9L 24V CR Diesel 2003-07 / Set	C15070	\$87.41
Ford 6.0L Power Stroke 2003-08 / Set	C15143	\$157.34
Ford 6.4L Power Stroke 2008-10 / Set	C15151	\$122.35
Ford 7.3L Power Stroke 1994-97 / Each	C15162	\$136.50
Ford 7.3L Power Stroke 1998-03 / Each	C15163	\$168.19

Domestic

Application	Part No.	Retail
Buick 400/430/455 1967-76	C15579	\$34.01
Chevy LT1/LT4 5.3L/6.2L 2014-2017	C15438	\$34.65
Chrysler 426 Hemi V8	C5976	\$41.95
Chrysler Big Block Wedge	C5983	\$25.98
Chrysler 318/340/360 LA V8 1964-1992	C15468	\$34.01
Chrysler/Dodge 5.7/6.1L Hemi 2003+Up Set - 1 Head	C5193	\$20.58
Ford 4.6L DOHC 1996-98	C5177	\$137.53
Ford 4.6L SOHC 1996-04	C5178	\$54.92
Ford 4.6L SOHC 2002-04 Truck	C5179	\$54.92
Ford Small Block 289,302,351W	C5974	\$19.47
Ford 429/460 Big Block V8	C15467	\$36.29
Ford 5.0L 2014-2017 / 5.2L 2015-2018 Set	C15442	\$127.27
GM Big Block Mark 4/5/6	C5975	\$25.98
GM LS V8 Gen 3/4 1999-14	C15245	\$27.46
GM Small Block 18/23* V8	C5973	\$25.98
Olds 330/350/400/403/455	C15440	\$25.98
Pont 265/301/350/400/428/455	C5044	\$25.98



Umbrella



Positive All Rubber



Positive Ring & Spring



Positive Ring & Band



O-Ring



Metal Jacket



Metal Jacket "Hat"

Metric Valve Stem

Stem OD	Guide OD	Height	OD	Type/Material	Part No.	Retail
8.0mm	12.0mm	9.6mm	15.5mm	Metal Jacket/Viton	3154V-16	\$38.13
6.0mm	10.7mm	11.5mm	13.8mm	Metal Jacket/Viton	3158V-16	\$26.52
6.0mm	11.75mm	15.0mm	14.6mm	Metal Jacket/Viton	3159V-16	\$26.52
8.0mm	.420"	.396"	.573"	Metal Jacket/Viton	3162V-16	\$46.17
8.0mm	12.3mm	12.0mm	17.0mm	Ring & Band/Viton	3164V-16	\$37.53
7.5mm	14.0mm	13.0mm	16.8mm	Metal Jacket/Viton	3168V-16	\$45.85
5.5mm	12.0mm	13.8mm	14.5mm	Metal Jacket/Viton (no int rubber)	3169V-16	\$53.18
5.0mm	11.0mm	10.0mm	12.85mm	Metal Jacket/Viton	3170V-16	\$24.56
6.0mm	9.8mm	10.0mm	13.2mm	Metal Jacket/Viton	3172V-16	\$55.87
5.5mm	11.8mm	12.0mm	14.75mm	Metal Jacket/Viton	3173V-16	\$37.74
6.0mm	11.0mm	9.3mm	13.4mm	Metal Jacket/Viton	3225V-16	\$30.91
8.5mm	12.5mm	2.0mm	11.9mm	O-ring/Viton	3174V-16	\$7.08
5.5mm	9.5mm	11.4mm	12.75mm	Metal Jacket/Viton	3175V-16	\$26.52
5.0mm	10.6mm	11.6mm	14.15mm	Metal Jacket/Viton	3176V-16	\$41.85
6.0mm	12.0mm	10.0mm	13.7mm	Metal Jacket/Viton	3177V-16	\$44.03
5.0mm	10.8mm	18.3mm	16.9mm	Metal Jacket (Hat)/Viton	3180V-16	\$39.39
5.5mm	11.6mm	20.2mm	17.2mm	Metal Jacket (Hat)/Viton	3181V-16	\$54.01
5.0mm	11.8mm	21.0mm	17.15mm	Metal Jacket (Hat)/Viton	3182V-16	\$58.17
7.0mm	11.0mm	9.5mm	14.4mm	Metal Jacket/Viton	3262V-16	\$31.25
5.0mm	11.0mm	8.0mm	13.4mm	Metal Jacket EXH/Viton	3264V-16	\$33.02
5.0mm	11.0mm	8.0mm	13.4mm	Metal Jacket INT/Viton	3265V-16	\$88.44
8.0mm	0.492"	0.47"	0.616"	Metal Jacket/Poly	3516P-16	\$32.19

1/4" Valve Stem

Stem OD	Guide OD	Height	OD	Type/Material	Part No.	Retail
1/4	0.435	0.392	0.531	Metal Jacket/Viton	3184V-16	\$31.63
1/4	0.476	0.517	0.562	Metal Jacket/Viton (no int rubber)	3232V-16	\$29.68
1/4	0.476	0.646	1.106	Metal Jacket (Hat)/Viton	3258V-16	\$19.45
1/4	0.48	0.794	1.106	Metal Jacket (Hat)/Viton	3259V-16	\$19.66

5/16" Valve Stem

Stem OD	Guide OD	Height	OD	Type/Material	Part No.	Retail
5/16	0.438	0.445	0.6	Ring & Band/Viton	3057V-16	\$55.03
5/16	0.562	0.461	0.71	Ring & Band/Viton	3060V-16	\$63.00
5/16	0.562	0.461	0.71	Ring & Band/Viton	3061V-16	\$49.33
5/16	0.563	0.58	0.712	Metal Jacket/Viton	3064V-16	\$70.75
5/16	0.514	0.403	0.61	Metal Jacket/Viton	3222V-16	\$31.63
5/16	0.531	0.516	0.677	Metal Body/Viton	3235V-16	\$35.76
5/16	0.491	0.531	0.623	Metal Body/Viton	3236V-16	\$37.74
5/16	0.476	0.517	0.562	Metal Body/Viton (no int rubber)	3237V-16	\$29.68
5/16	0.562	1.085	1.3888	Metal Jacket (Hat)/Viton	3216V-16	\$72.47

See page 14 for additional valve stem seals



Umbrella



Positive All Rubber



Positive Ring & Spring



Positive Ring & Band



O-Ring



Metal Jacket



Metal Jacket "Hat"

11/32" Valve Stem

Stem OD	Guide OD	Height	OD	Type/Material	Part No.	Retail
11/32	0.5	0.54	0.64	Ring & Band/Viton	3012V-16	\$35.95
11/32	0.52	0.47	0.69	Positive 2-Ring/Nitrile	3013N-16	\$8.05
11/32	0.53	0.485	0.71	Ring & Band/Nitrile	3014N-16	\$9.35
11/32	0.53	0.485	0.71	Ring & Band/Viton	3024V-16	\$37.93
11/32	0.563	0.47	0.69	Ring & Band/Viton	3066V-16	\$36.98
11/32	0.5	0.531	0.623	Metal Jacket/Viton	3188V-16	\$35.11
11/32	0.562	0.485	0.677	Ring & Band/Viton	3192V-16	\$37.81
11/32	0.472	0.435	0.677	Metal Jacket/Viton	3223V-16	\$31.63
11/32	0.53	0.527	0.674	Metal Jacket/Viton	3228V-16	\$39.67
11/32	0.583	0.4	0.74	Metal Jacket/Viton	3245V-16	\$28.69

3/8" Valve Stem

Stem OD	Guide OD	Height	OD	Type/Material	Part No.	Retail
3/8	0.623	0.47	0.79	Positive-2-Ring/Nitrile	3017N-16	\$18.57
3/8	0.75	0.83	0.875	Umbrella Seal/Viton/Teflon	3050V-16	\$36.16
3/8	0.5	0.531	0.623	Metal Jacket/Viton	3195V-16	\$31.63
3/8	0.53	0.516	0.677	Metal Jacket/Viton	3196V-16	\$35.76
3/8	0.562	0.516	0.661	Metal Jacket/Viton	3197V-16	\$31.63
3/8	0.625	0.531	0.742	Metal Jacket/Viton	3198V-16	\$35.76

Misc. Valve Stem

Stem OD	Guide OD	Height	OD	Type/Material	Part No.	Retail
0.276	0.476	0.517	0.562	Metal Jacket/Viton (no int rubber)	3199V-16	\$29.68
-	-	0.975	0.97	Metal Jacket (Hat)/Viton	3240V-16	\$69.58
0.287	0.49	0.887	1.185	Metal Jacket (Hat) INT/Viton	3255V-16	\$27.91
0.287	0.49	0.887	1.185	Metal Jacket (Hat) EXH/Viton	3256V-16	\$29.49
0.281	0.53	1.035	1.372	Metal Jacket (Hat)/Viton	3260V-16	\$77.90
0.281	0.53	1.14	1.255	Metal Jacket (Hat)/Viton	3261V-16	\$50.68
0.265	0.5	0.555	0.645	Metal Jacket/Intake	3214V-16	\$44.59
0.265	0.5	0.555	0.638	Metal Jacket/Exhaust	3215V-16	\$58.20
0.265	-	1.02	1	Metal Jacket (Hat)/Viton	3217V-16	\$81.44
0.265	0.5	0.635	1.126	Metal Jacket/Intake/Yellow	3218V-16	\$36.86
0.265	0.5	0.635	0.645	Metal Jacket/Exhaust/Green	3219V-16	\$36.86
0.198	0.334	0.39	0.482	Metal Jacket/Viton	3246V-16	\$27.21
0.204	-	0.555	0.645	Metal Jacket	3257V-16	\$44.12

AMC

4.0L Inline 6 242ci 1987-2006: 87-01 Cherokee, 93-04 Grand Cherokee, 87-90 Wagoneer, 87-92 Comanche, 91-06 Wrangler

Head Gaskets

MLS Head Gaskets

Bore	Thickness	Pkg Qty	Part No.	Retail
3.950"	.050"	1	C5987-050	\$137.55
4.000"	.050"	1	C5988-050	\$137.55
4.060"	.050"	1	C5989-050	\$137.55

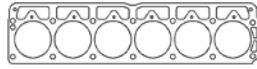

Additional thicknesses available
see pages 2 - 4

Individual Gaskets

Timing Cover Set

Application	Part No.	Retail
3.8/4.0/4.2L I6 1965-2006	C5047	\$20.58

290-401ci V8

Head Gaskets

MLS Head Gaskets

Fits: 290 1966-69, 304 1970-78, 343 1967-69, 360 1970-91

Bore	Thickness	Pkg Qty	Part No.	Retail
3.810"	.040"	1	C5669-040	\$107.27
4.140"	.040"	1	C5674-040	\$107.27

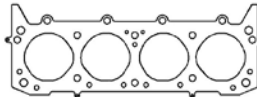

Additional thicknesses available
see pages 2 - 4

MLS Head Gaskets

Fits: 390 1970 & 401 1972-74

Bore	Thickness	Pkg Qty	Part No.	Retail
4.250"	.040"	1	C5937-040	\$107.27
4.380"	.040"	1	C5938-040	\$107.27

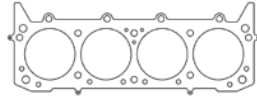

MLS Head Gaskets

Fits: INDY 401 Aftermarket Heads

Bore	Thickness	Pkg Qty	Part No.	Retail
4.380"	.040"	1	C5409-040	\$107.27
4.380"	.080"	1	C5409-080	\$156.31

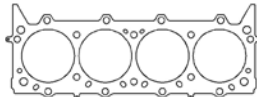

Individual Gaskets

Exhaust Gasket Set

Application	Part No.	Retail
304-401ci w/Dogleg Ports	C5161-064	\$29.75
304-401ci w/Rectangle Ports	C5101-064	\$29.75

Intake Gasket Set

Application	Part No.	Retail
290-401 V8 1970-91 1.13" x 2.22"	C15002-060	\$33.73
390/401 Indy Head 1.20" x 2.30"	C15003-060	\$33.73

Valve Cover Gasket (sold individually)

Application	Part No.	Retail
390/401ci V8 Indy Head	C5115-188	\$19.02

Timing Cover Set

Application	Part No.	Retail
290-401ci V8 1966-88	C5046	\$19.47

BUICK / GM

196, 231, 252ci V6 Stock, Stage I, and Stage II

Head Gaskets

MLS Head Gaskets - Stock

Bore	Thickness	Pkg Qty	Part No.	Retail
3.860"	.040"	1	C15577-040	\$102.61



Additional thicknesses available
see pages 2 - 4

MLS Head Gaskets - Stage I, Stage II

Bore	Thickness	Pkg Qty	Part No.	Retail
3.860"	.040"	1	C5691-040	\$102.61
4.020"	.040"	1	C5692-040	\$102.61
4.090"	.040"	1	C5693-040	\$102.61

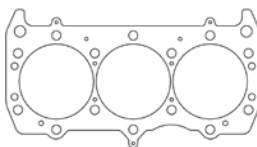

See page 16 for additional gaskets



BUICK / GM

196, 231, 252ci V6 Stock, Stage I, and Stage II (continued)

Head Gaskets (continued)

Copper Head Gaskets

Bore	Thickness	Pkg Qty	Part No.	Retail
3.860"	.043"	1	C15407-043	\$114.65

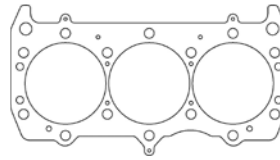

Additional thicknesses available
see pages 2 - 4

Individual Gaskets

Exhaust Gasket Set

Application	Part No.	Retail
Stock & Stage I Ports AM Material	C5696-064	\$33.16
Stock & Stage I Ports MLS	C15641-030	\$48.14
Stage II Ports AM Material	C5791-064	\$33.16

Intake Gasket Set

Application	Part No.	Retail
Stock & Stage I Ports	C5694-060	\$28.95
Stage II Ports	C5792-060	\$33.16

Valve Cover Gasket (sold individually)

Application	Part No.	Retail
Iron & Aluminum Heads	C5697-188	\$19.02

Timing Cover Set

Application	Part No.	Retail
66-87 V6/Small V8 w/Rope Seal	C5048	\$27.46
66-87 V6/Small V8 w/Radial Seal	C5049	\$20.58

Rear Main Seal

Application	Part No.	Retail
2 Piece w/Side Rails	C5707	\$22.14

Oil Pan Gasket

Application	Part No.	Retail
20 Bolt	C5700-094	\$36.75

3800 Series II/III V6 L26, L32, L36, L67 1995-2003, 2003-2009

Head Gaskets

MLS Head Gaskets - Left Side

Bore	Thickness	Pkg Qty	Part No.	Retail
3.840"	.066"	1	C5720-066	\$156.31

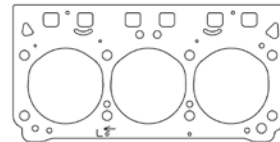

Additional thicknesses available
see pages 2 - 4

MLS Head Gaskets - Right Side

Bore	Thickness	Pkg Qty	Part No.	Retail
3.840"	.066"	1	C5721-066	\$156.31

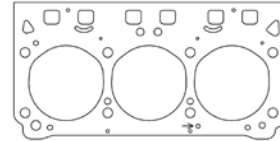

350 1968-81

Head Gaskets

MLS Head Gaskets

Bore	Thickness	Pkg Qty	Part No.	Retail
3.890"	.040"	1	C15267-040	\$109.94

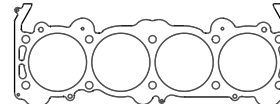

Additional thicknesses available
see pages 2 - 4

400, 430 & 455 V8 - All Years

Head Gaskets

MLS Head Gaskets

Bore	Thickness	Pkg Qty	Part No.	Retail
4.312"	.040"	1	C5753-040	\$109.94
4.385"	.040"	1	C5754-040	\$109.94
4.400"	.040"	1	C5755-040	\$109.94

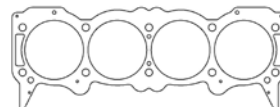

Additional thicknesses available
see pages 2 - 4

Individual Gaskets

Exhaust Gasket Set

Application	Part No.	Retail
All Years	C5776-064	\$35.14

Valve Cover Gasket (sold individually)

Application	Part No.	Retail
Buick 400/430/455 1967-76 .188" Molded Rubber	C15579	\$34.01
Buick 400/430/455 1967-76 V8 .094" KF	C5774-094	\$22.05

See page 17 for additional gaskets

BUICK / GM

400, 430 & 455 V8 - All Years (continued)

Individual Gaskets (continued)

Intake Gasket Set		
Application	Part No.	Retail
1967-71 1.172" x 2.453" Rectangle Port	C5143-060	\$32.26
1972-76 1.156" x 2.422" Rectangle Port	C5775-060	\$33.83

Water Pump Gasket		
Application	Part No.	Retail
1967-76 Water Pump Gasket	C5144-031	\$12.34
1967-76 Water Outlet Gasket	C15004-031	\$2.24

Oil Pan Gasket		
Application	Part No.	Retail
1967-76 4pc Set	C5145	\$42.27

Timing Cover Set		
Application	Part No.	Retail
67-76 400, 430, 455 V8	C5050	\$19.47

Gasket Kits



To purchase a complete gasket kit order both top end and bottom end gasket kit

TOP END GASKET KIT

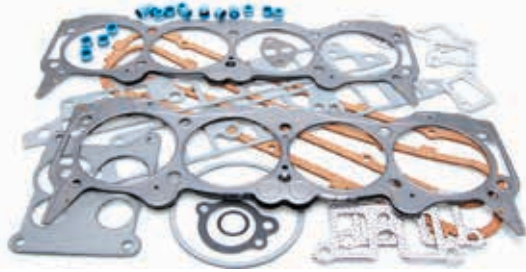

Application	Part No.	Retail
Big Block 455ci 1970-76 4.385" Bore	PRO1011T	\$237.21

BOTTOM END GASKET KIT

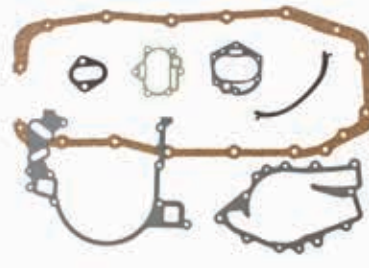

Application	Part No.	Retail
Big Block 455ci 1970-76	PRO1011B	\$40.06

CADILLAC

Northstar 4.6L 32v V8 L37, LD8 FWD 1993-2011

Head Gaskets

MLS Head Gaskets - Left Side				
Bore	Thickness	Pkg Qty	Part No.	Retail
3.700"	.066"	1	C5717-066	\$168.93

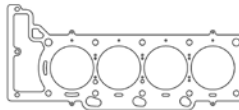

Additional thicknesses available
see pages 2 - 4

MLS Head Gaskets - Right Side				
Bore	Thickness	Pkg Qty	Part No.	Retail
3.700"	.066"	1	C5716-066	\$168.93

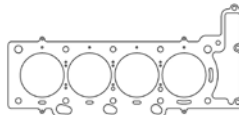

LTG Gen-3 ECOTEC 2013-2020

MLX Head Gaskets - LTG 2.0L DOHC				
Bore	Thickness	Pkg Qty	Part No.	Retail
87mm	.028"	1	C4964-028	\$156.31
87mm	.040"	1	C4964-040	\$156.31

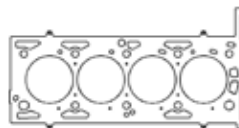

CHEVROLET / GM

ECOTEC 4 Cylinder

Head Gaskets

MLX Head Gasket - L3A/LE2/LFV/LV7/LYX 1.4L/1.5L 17-20				
Bore	Thickness	Pkg Qty	Part No.	Retail
75mm	.044"	1	C15565-044	\$128.10

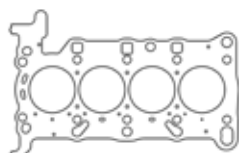

Additional thicknesses available
see pages 2 - 4

See page 18 for additional gaskets



CHEVROLET / GM

ECOTEC 4 Cylinder (continued)

Head Gaskets (continued)

MLS Head Gasket - LSJ 2.0L

Bore	Thickness	Pkg Qty	Part No.	Retail
87mm	.027"	1	C5921-027	\$112.63

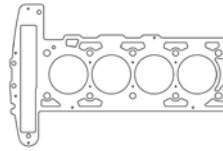

Additional thicknesses available
see pages 2 - 4

MLX Head Gasket - LSJ 2.0L

Bore	Thickness	Pkg Qty	Part No.	Retail
87mm	.040"	1	C5032-040	\$156.31

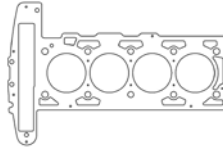

MLX Head Gasket - LNF 2.0L 08-10

Bore	Thickness	Pkg Qty	Part No.	Retail
88mm	.032"	1	C15256-032	\$156.31

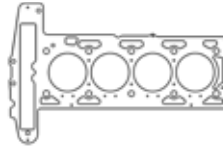

MLX Head Gasket - LTG 2.0L DOHC

Bore	Thickness	Pkg Qty	Part No.	Retail
87mm	.028"	1	C4964-028	\$156.31

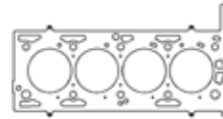

MLS Head Gaskets - L61/L42 2.2L DOHC

Bore	Thickness	Pkg Qty	Part No.	Retail
87mm	.040"	1	C5768-040	\$112.63
89mm	.040"	1	C5804-040	\$112.63

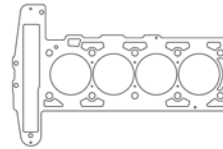

MLX Head Gaskets - LAT/LE5/LE9 Gen-2 ECOTEC 2.4L

Bore	Thickness	Pkg Qty	Part No.	Retail
89.6mm	.036"	1	C15422-036	\$156.31

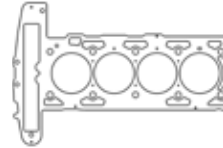

Individual Gaskets

MLS Exhaust Gasket - L42/L61/LAT/LE5 Gen-1/2 ECOTEC 2.2/2.4L

Application	Part No.	Retail
2000-2009 2.2/2.4L	C4150-030	\$27.22

2.2L 134ci "L43/LN2": Cavalier/Sunfire FWD 1998-02, S-10/Sonoma RWD 1998-03

Head Gaskets

MLS Head Gaskets

Bore	Thickness	Pkg Qty	Part No.	Retail
90mm	.030"	1	C5914-030	\$112.63
93mm	.030"	1	C5915-030	\$112.63

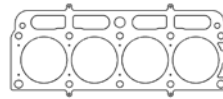

Additional thicknesses available
see pages 2 - 4

2.4L 146ci "LD9" Twin Cam 1996-2001

Head Gaskets

MLS Head Gaskets - 1996-99 w/EGR

Bore	Thickness	Pkg Qty	Part No.	Retail
3.595"	.030"	1	C5298-030	\$107.27

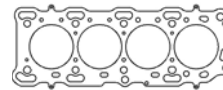

Additional thicknesses available
see pages 2 - 4

MLS Head Gaskets - 1999-01 w/o EGR

Bore	Thickness	Pkg Qty	Part No.	Retail
3.595"	.030"	1	C5866-030	\$107.27
3.595"	.075"	1	C5866-075	\$156.31

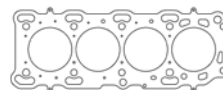



CHEVROLET / GM

2.5L 153ci 1965-79 / 3.0L VORTEC 3000 (Marine)

Head Gaskets

MLS Head Gaskets

Bore	Thickness	Pkg Qty	Part No.	Retail
4.100"	.045"	1	C5956-045	\$102.61

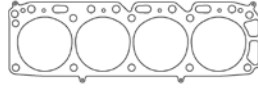

Additional thicknesses available
see pages 2 - 4

3.1L L82/LG8, 3.4L LA1 Gen-3 60 Degree V6

Head Gaskets

MLS Head Gaskets - 3.1L L82/LG8 1993-05

Bore	Thickness	Pkg Qty	Part No.	Retail
91mm	.051"	1	C5220-051	\$110.88

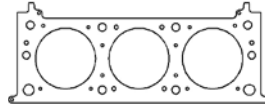

Additional thicknesses available
see pages 2 - 4

MLS Head Gaskets - 3.4L LA1 1996-05

Bore	Thickness	Pkg Qty	Part No.	Retail
95mm	.051"	1	C5266-051	\$110.88

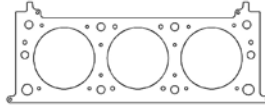

Individual Gaskets

Exhaust Gasket Set

Application	Part No.	Retail
1993-05 3.1/3.4L V6	C15005-064	\$22.61

3.5L LZ4/LZE, 3.9L LGD/LZ8/LZ9/LZG High Value V6 2006-2011

Head Gaskets

MLS Head Gaskets - Left Side

Bore	Thickness	Pkg Qty	Part No.	Retail
101mm	.051"	1	C5226-051	\$110.88

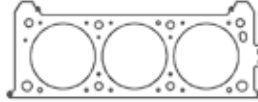

Additional thicknesses available
see pages 2 - 4

MLS Head Gaskets - Right Side

Bore	Thickness	Pkg Qty	Part No.	Retail
101mm	.051"	1	C5227-051	\$110.88

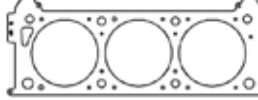

3.6L LY7/LLT/LFX/LFR/LFY High Feature V6 2004-Present

Head Gaskets

MLX Head Gasket - Left Side

Bore	Thickness	Pkg Qty	Part No.	Retail
98mm	.044"	1	C5029-044	\$110.88

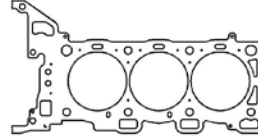

Additional thicknesses available
see pages 2 - 4

MLX Head Gasket - Right Side

Bore	Thickness	Pkg Qty	Part No.	Retail
98mm	.044"	1	C5028-044	\$110.88

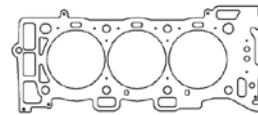

3.6L LF3/LF4 High Feature V6 2014-Present

Head Gaskets

MLX Head Gaskets - Left Side

Bore	Thickness	Pkg Qty	Part No.	Retail
96mm	.048"	1	C15695-048	\$137.84

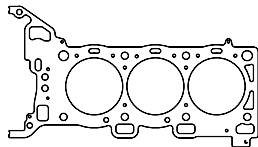

Additional thicknesses available
see pages 2 - 4

MLX Head Gaskets - Right Side

Bore	Thickness	Pkg Qty	Part No.	Retail
96mm	.048"	1	C15694-048	\$137.84

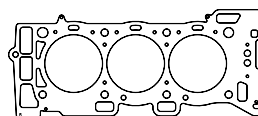



CHEVROLET / GM

4.3L 262ci 90 Degree V6 1985-2014

Head Gaskets

MLS Head Gaskets

Bore	Thickness	Pkg Qty	Part No.	Retail
4.060"	.040"	1	C5739-040	\$112.63
4.120"	.040"	1	C5740-040	\$112.63
4.155"	.040"	1	C5741-040	\$112.63

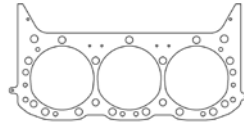

Additional thicknesses available
see pages 2 - 4

Individual Gaskets

Valve Cover Gasket (sold individually)

Application	Part No.	Retail
4.3L V6 .125" Molded Rubber, Center Bolt	C15006-125	\$15.44

Timing Cover Set

Application	Part No.	Retail
1985-95 w/Thick Front OP Seal	C5051	\$19.47

Intake Manifold Gaskets

Application	Part No.	Retail
4.3L V6 .060" Fiber, No EGR Passage	C15007-060	\$33.25

Water Pump Gasket

Application	Part No.	Retail
.018" AFM Material	C5299-018	\$3.77

Exhaust Manifold Gaskets

Application	Part No.	Retail
1985-92 4.3L V6 .064" AM	C15008-064	\$22.61

Oil Pan Gasket

Application	Part No.	Retail
1978-95 4 Piece Set	C5496	\$30.94

Fuel Pump Mounting Gasket

Application	Part No.	Retail
1985-96 4.3L V6 .020" Fiber	C15009-020	\$2.60

Rear Main Seal Kit

Application	Part No.	Retail
1 Piece Design	C5106	\$30.94

Gasket Kits



To purchase a complete gasket kit order both top end and bottom end gasket kit

TOP END GASKET KIT

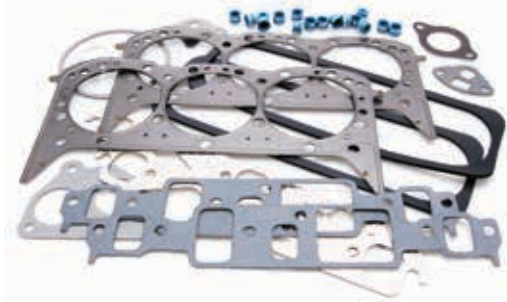

Application	Part No.	Retail
4.3L V6 1985-93 4.120" Bore	PRO1006T	\$207.24

BOTTOM END GASKET KIT



Application	Part No.	Retail
4.3L V6 1985-93	PRO1006B	\$66.77

4.3L LV1, LV3 EcoTec3 V6 2014-Present

Head Gaskets

NEW!

MLX Head Gaskets - Left Side

Bore	Thickness	Pkg Qty	Part No.	Retail
4.000"	.054"	1	C15278-054	\$112.63

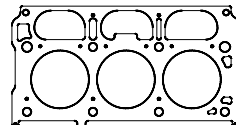

Additional thicknesses available
see pages 2 - 4

NEW!

MLX Head Gaskets - Right Side

Bore	Thickness	Pkg Qty	Part No.	Retail
4.000"	.054"	1	C15277-054	\$112.63

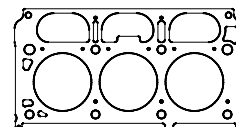



CHEVROLET / GM

194, 230, 250, 292 Inline 6 1962-89

Head Gaskets

MLS Head Gaskets

Bore	Thickness	Pkg Qty	Part No.	Retail
4.125"	.040"	1	C5699-040	\$201.10

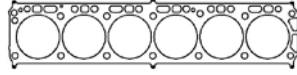

Additional thicknesses available
see pages 2 - 4

Individual Gaskets

Intake Exhaust Manifold Gasket

Application	Part No.	Retail
I6 Intake .059" CFM	C15010-059	\$61.93

Timing Cover Set

Application	Part No.	Retail
4/6 Cyl 151/230/250/292	C5053	\$19.47

4.2L Inline 6 "LL8" Vortec 4200 2002-09

Head Gaskets

MLX Head Gaskets

Bore	Thickness	Pkg Qty	Part No.	Retail
3.710"	.040"	1	C15374-040	\$215.84

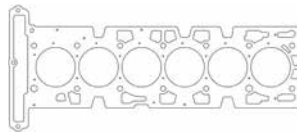

Additional thicknesses available
see pages 2 - 4

18/23 Degree Small Block V8 262-400ci (*has steam holes)

Head Gaskets

MLS Head Gaskets - Round Bore

Bore	Thickness	Pkg Qty	Part No.	Retail
4.030"	.040"	1	C15754-040	\$97.72
4.060"	.040"	1	C5245-040	\$97.72
4.100"	.040"	1	C5246-040	\$97.72
4.125"	.040"	1	C5247-040*	\$97.72
4.165"	.040"	1	C5248-040*	\$97.72
4.165"	.040"	1	C15504-040	\$97.72
4.200"	.040"	1	C5249-040*	\$97.72
4.200"	.040"	1	C15499-040	\$97.72

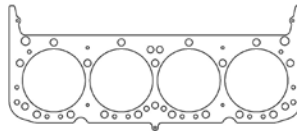

Additional thicknesses available
see pages 2 - 4

MLS Head Gaskets - Valve Pocketed Bore

Bore	Thickness	Pkg Qty	Part No.	Retail
4.060"	.040"	1	C5269-040	\$97.72
4.100"	.040"	1	C5270-040	\$97.72
4.125"	.040"	1	C5271-040*	\$97.72
4.165"	.040"	1	C5272-040*	\$97.72
4.200"	.040"	1	C5273-040*	\$97.72

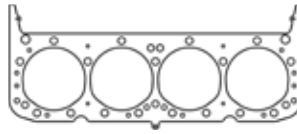

MLX Head Gaskets - Round Bore

Bore	Thickness	Pkg Qty	Part No.	Retail
4.165"	.040"	1	C5031-040	\$125.65
4.200"	.040"	1	C15575-040	\$125.65
4.220"	.040"	1	C5786-040*	\$125.65

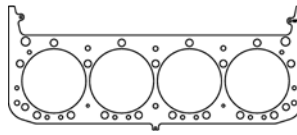

Copper Head Gaskets - Round Bore

Bore	Thickness	Pkg Qty	Part No.	Retail
4.165"	.043"	1	C15411-043	\$128.57

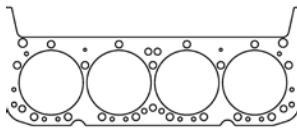

Copper Head Gaskets - No Steam Holes

Bore	Thickness	Pkg Qty	Part No.	Retail
4.200"	.043"	1	C15412-043	\$128.57

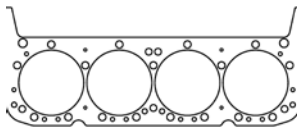

See page 22 for additional gaskets



CHEVROLET / GM

18/23 Degree Small Block V8 262-400ci (*has steam holes) (continued)

Individual Gaskets

Valve Cover Gaskets (sold individually)		
Application	Part No.	Retail
18/23° Molded Rubber	C5973	\$25.98
Splayed Valve Heads	C5390-094	\$22.61
23° .188" Fiber 1986-02 Center Bolt, Pair	C15206	\$39.96

Intake Manifold Gaskets		
Application	Part No.	Retail
18° Heads 1.35" X 2.25" Port	C5541-060	\$33.73
23° Heads 1.245" x 1.980" Rectangle Port	C5544-060	\$33.73
23° Heads 1.240" x 2.100" Rectangle Port	C5542-060	\$33.73
23° Heads 1.282" x 2.175" Rectangle Port	C5528-060	\$33.73
305/350 w/TPI 1985-92 Set	C15198	\$40.14
End Seal Gaskets	C5536-060	\$7.08

Exhaust Manifold Gaskets		
Application	Part No.	Retail
18° 1.50" x 1.47" .064" AM	C5314-064	\$40.86
23° 1.450" x 1.480" Rectangle .030" MLS	C5892-030	\$47.05
23° 1.500" Round .030" MLS	C5891-030	\$47.05
23° 1.450" x 1.600" Rectangle .030" MLS	C5894-030	\$48.31
23° 1.625" Round .030" MLS	C5893-030	\$48.31
23° 1.480" x 1.45" .030" MLS	C15190-030	\$43.86

Fuel Pump Mounting Gaskets		
Application	Part No.	Retail
2 Bolt - .032" AFM	C5389-032	\$2.05
4 Bolt - .032" AFM	C15012-032	\$2.05

Timing Cover Set		
Application	Part No.	Retail
1957-74 w/Thin Front OP Seal	C5052	\$19.47
1975-95 w/Thick Front OP Seal	C5051	\$19.47

Oil Pan Gasket Set		
Application	Part No.	Retail
1955-79 LH Dipstick 4pc Kit	C5295-094	\$35.14
1980-85 RH Dipstick 4pc Kit	C5294	\$35.14
1955-85 Dual Dipstick 1 pc Molded Rubber	C15546	\$40.01
1986-97 1 pc Molded Rubber	C5072	\$44.95

Water Pump Gaskets		
Application	Part No.	Retail
Water Pump MTG Gasket	C5299-018	\$3.77
Water Pump Backing Plate Gsk	C15011-032	\$6.93

Thermostat Gasket		
Application	Part No.	Retail
.047" Fiber	C5538-047	\$1.30

Rear Main Seal Kit		
Application	Part No.	Retail
2 Piece SN	C5680	\$29.75
1 Piece SN	C5106	\$30.94

Distributor Gasket		
Application	Part No.	Retail
.060" Fiber	C5531-060	\$1.49

Gasket Kits



To purchase a complete gasket kit order both top end and bottom end gasket kit

TOP END GASKET KITS

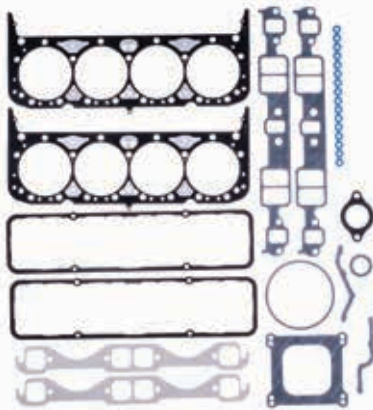

Application	Part No.	Retail
350ci (67-85) & 400ci (70-76) 4.165" Bore	PRO1003T	\$282.15
350ci TPI (87-92), TBI (86-93) 4.100" Bore	PRO1004T	\$294.63
ZZ4 Crate Engine 4.080" Bore	PRO1026T	\$262.16

BOTTOM END GASKET KITS

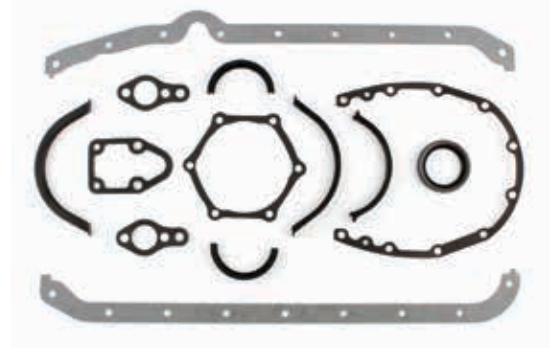

Application	Part No.	Retail
350ci (67-79) & 400ci (70-76)	PRO1003B	\$88.62
350ci (86-93) 1pc Rear Main	PRO1004B	\$80.14



CHEVROLET / GM

Small Block V8 - Aftermarket & Race

Head Gaskets

MLS Head Gaskets - Vortec Head

Bore	Thickness	Pkg Qty	Part No.	Retail
4.080"	.040"	1	C5474-040	\$97.72
4.165"	.040"	1	C5410-040	\$97.72

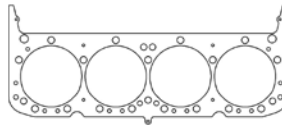

Additional thicknesses available
see pages 2 - 4

MLS Head Gaskets - Edelbrock RPM Heads

Bore	Thickness	Pkg Qty	Part No.	Retail
4.135"	.040"	1	C5274-040	\$97.72

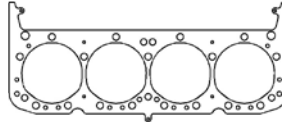

MLS Head Gaskets - Brodix BD2000

Bore	Thickness	Pkg Qty	Part No.	Retail
4.030"	.040"	1	C5404-040	\$94.98
4.125"	.040"	1	C5405-040	\$94.98
4.135"	.040"	1	C5406-040	\$94.98
4.160"	.040"	1	C5407-040	\$94.98
4.200"	.040"	1	C5408-040	\$94.98

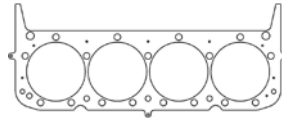

MLS Head Gaskets - Aftermarket Heads Undersized Water Ports to Allow for Customization

Bore	Thickness	Pkg Qty	Part No.	Retail
4.030"	.040"	1	C5399-040	\$94.98
4.125"	.040"	1	C5400-040	\$94.98
4.135"	.040"	1	C5401-040	\$94.98
4.160"	.040"	1	C5402-040	\$94.98
4.200"	.040"	1	C5403-040	\$94.98

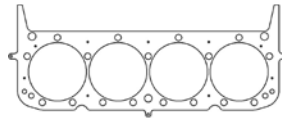

MLX Head Gaskets - All Pro Heads

Bore	Thickness	Pkg Qty	Part No.	Retail
4.220"	.040"	1	C5551-040	\$125.65

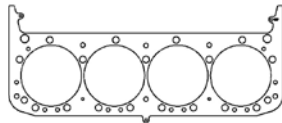

MLS Head Gaskets - Dart/Brodix 4.5" Bore Spacing

Bore	Thickness	Pkg Qty	Part No.	Retail
4.270"	.036"	1	C5215-036	\$100.59
4.270"	.040"	1	C5215-040	\$100.59
4.270"	.045"	1	C5215-045	\$105.62

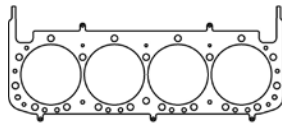

MLX Head Gaskets - Dart/Brodix 4.5" Bore Spacing

Bore	Thickness	Pkg Qty	Part No.	Retail
4.310"	.040"	1	C15208-040	\$125.65

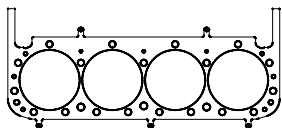

Individual Gaskets

Intake Manifold Gaskets

Application	Part No.	Retail
23° Dart Cast Iron 1.282" x 2.175" Rectangle Port	C5528-060	\$33.73
Brodix BD2000	C5421-060	\$29.76
Brodix WP 12S	C5425-059	\$29.76
Brodix WP 247	C5426-059	\$29.76
Brodix WP 262	C5427-059	\$29.76
Brodix GB 2000	C5423-059	\$29.76
Brodix Track 1 & Spec Head	C5414-059	\$29.76
Brodix Street	C5416-059	\$29.76
End Seal Gaskets	C5536-060	\$7.08

Exhaust Manifold Gaskets

Application	Part No.	Retail
All Pro 286 - .064" AM	C15707-064	\$26.44
Brodix GB 2000 - .064" AM	C5422-064	\$25.11
Brodix Track 1 - .064" AM	C5415-064	\$25.11
Brodix Street - .064" AM	C5417-064	\$25.11
Brodix/All Pro 286 (7 Bolt) MLS	C5040-030	\$43.65
Brodix/Dart 13° 4.4/4.5" Spacing	C5039-030	\$43.65

Oil Pan Gasket

Application	Part No.	Retail
Dart Iron Eagle/Rocket Block	C5104-094	\$47.70



CHEVROLET / GM

RaceSaver 305 Sprint V8

Head Gaskets

ML Head Gaskets				
Bore	Thickness	Pkg Qty	Part No.	Retail
3.800"	.040"	1	C15684-040	\$97.72

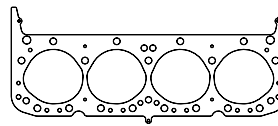

Additional thicknesses available
see pages 2 - 4

Individual Gaskets

Intake Manifold Gaskets		
Application	Part No.	Retail
RaceSaver 305 Sprint V8 1.287" x 2.094" Rectangle Port	C15685-060	\$35.39

350 & 400 SB2 Race V8

Head Gaskets

MLS Head Gaskets				
Bore	Thickness	Pkg Qty	Part No.	Retail
4.125"	.040"	1	C5321-040	\$97.72
4.165"	.040"	1	C5323-040	\$97.72
4.190"	.040"	1	C5472-040	\$97.72
4.200"	.040"	1	C5324-040	\$97.72

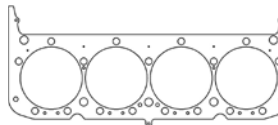

Additional thicknesses available
see pages 2 - 4

Individual Gaskets

Valve Cover Gasket (sold individually)		
Application	Part No.	Retail
SB2 - .188" Thickness	C5235-188	\$23.91

Timing Cover Gasket		
Application	Part No.	Retail
SB2 - .020" RC	C5533-020	\$23.91

Intake Manifold Gaskets		
Application	Part No.	Retail
SB2 - 2.085" x 1.560" Ports	C5311-031	\$38.01
SB2 - MLS	C5819-040	\$84.37

Water Pump Gasket		
Application	Part No.	Retail
Water Pump MTG Gasket	C5299-018	\$3.77
Water Pump Backing Plate Gsk	C15011-032	\$6.93

Intake Valley Plate Gaskets		
Application	Part No.	Retail
Stock Opening - .060" AFM	C5647-060	\$27.16
.970" Holes - .060" AFM	C5308-060	\$27.16
.625"/.750" Holes - .060" AFM	C5307-060	\$27.16

Exhaust Manifold Gaskets		
Application	Part No.	Retail
1.50" x 1.60" Ports - MLS	C5552-065	\$40.18
1.90" x 1.63" Ports - MLS	C5836-030	\$63.74

Rear Main Seal		
Application	Part No.	Retail
Dual Lip/High Vacuum	C5379	\$95.05

Oil Pan Gasket		
Application	Part No.	Retail
SB2 - 4pc Set	C5553-060	\$44.63

Distributor Gasket		
Application	Part No.	Retail
.060" Fiber	C5531-060	\$1.49

Fuel Pump Mounting Gasket		
Application	Part No.	Retail
4 Bolt - .032" AFM	C15012-032	\$2.05

R07.2 Race V8

Head Gasket

MLX Head Gasket				
Bore	Thickness	Pkg Qty	Part No.	Retail
4.220"	.040"	1	C5577-040	\$126.49

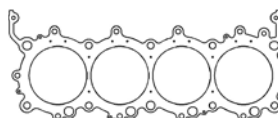

Additional thicknesses available
see pages 2 - 4

Individual Gaskets

Rubber Seal/O-Ring Kit		
Application	Part No.	Retail
R07.2	C5979	\$270.72

Valve Cover Gasket (sold individually)		
Application	Part No.	Retail
Nitrile Formed Rubber O-Ring	C15013	\$21.67



CHEVROLET / GM

LT1 / LT4 350ci 1992-1996

Head Gaskets

MLS Head Gaskets

Bore	Thickness	Pkg Qty	Part No.	Retail
4.040"	.040"	1	C5645-040	\$97.72
4.100"	.040"	1	C5646-040	\$97.72

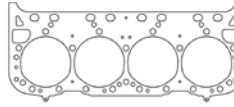

Additional thicknesses available
see pages 2 - 4

Individual Gaskets

Valve Cover Gasket (sold individually)

Application	Part No.	Retail
.094" Thickness	C15014-094	\$14.13

Exhaust Manifold Gaskets

Application	Part No.	Retail
1.52" x 1.51" Ports, MLS	C5895-030	\$49.55

Intake Manifold Gaskets

Application	Part No.	Retail
LT1/LT4 - 2.085" x 1.560" Ports	C15015-060	\$39.28

Throttle Body Gasket Gasket

Application	Part No.	Retail
1992-97 LT1/LT4	C15016-060	\$6.57

Oil Pan Gasket Set

Application	Part No.	Retail
1992-97 1 pc Molded Rubber	C5072	\$44.95

Rear Main Seal Kit

Application	Part No.	Retail
1 Piece SN	C5106	\$30.94

Exhaust Pipe Gasket

Application	Part No.	Retail
Header Collector Gasket	C15017-064	\$5.15
Y-Pipe Gasket	C15018-064	\$7.75

Timing Cover Sets

Application	Part No.	Retail
1992-94	C5054	\$33.80
1994-97	C5055	\$25.98

Water Pump Gasket

Application	Part No.	Retail
Water Pump Mounting Gasket	C15019-031	\$6.32

LS1/LS6 5.7L, LS2 6.0L, & LS3 6.2L, GEN 3/4 LS SERIES V8

Head Gaskets

MLS Head Gaskets

Bore	Thickness	Pkg Qty	Part No.	Retail
3.810"	.051"	1	C15361-051	\$97.72
3.910"	.051"	1	C5475-051	\$97.72
4.000"	.051"	1	C5477-051	\$97.72
4.060"	.051"	1	C5751-051	\$97.72
4.100"	.051"	1	C5489-051	\$97.72
4.130"	.051"	1	C5317-051	\$97.72
4.160"	.051"	1	C5318-051	\$97.72
4.190"	.051"	1	C5319-051	\$97.72

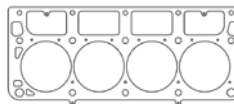

Additional thicknesses available
see pages 2 - 4

MLX Head Gaskets

Bore	Thickness	Pkg Qty	Part No.	Retail
3.940"	.052"	1	C15724-052	\$128.10
4.040"	.052"	1	C5505-052	\$125.65
4.100"	.052"	1	C15747-052	\$131.93
4.150"	.052"	1	C5014-052	\$131.93

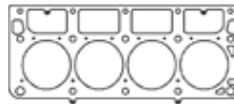

Fits standard 7/16 studs, and 1/2" studs

NEW!

DST Head Gaskets

Bore	Thickness	Pkg Qty	Part No.	Retail
3.940"	.063"	1	C15739-063	\$313.95
3.940"	.071"	1	C15739-071	\$313.95
4.040"	.063"	1	C15740-063	\$313.95
4.040"	.071"	1	C15740-071	\$313.95
4.100"	.063"	1	C15749-063	\$313.95
4.100"	.071"	1	C15749-071	\$313.95
4.150"	.063"	1	C15741-063	\$313.95
4.150"	.071"	1	C15741-071	\$313.95

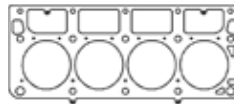

Fits standard 7/16 studs, and 1/2" studs

Copper Head Gaskets

Bore	Thickness	Pkg Qty	Part No.	Retail
4.100"	.050"	1	C15408-050	\$122.45
3.800-4.250"	.020 - .094	Available Through Custom Order		

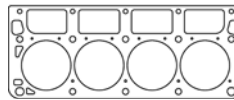

See page 26 for additional gaskets



CHEVROLET / GM

LS1 / LS6 5.7L, LS2 6.0L, & LS3 6.2L (continued)

Individual Gaskets

Valve Cover Gasket (sold individually)		
Application	Part No.	Retail
Gen-3/4 LS V8 - Center Bolt	C5170	\$15.44
Gen-3/4 Valve Cover Grommet Set	C15030	\$13.22

Intake Manifold Gaskets		
Application	Part No.	Retail
99-05 5.7/6.0L Car Intake	C5165	\$46.58
99-05 5.3/6.0L Truck Intake	C5166	\$83.30
LS3/L92 Carb Intake Gaskets	C15022-060	\$31.12
08-13 LS3 6.2L Car Intake	C5037	\$43.00
07-13 6.0/6.2L Truck Intake	C15024	\$121.28
Gen-3 LS Valley Gasket	C15026	\$27.64
Gen-4 LS w/ D.O.D. Valley Gasket	C15023	\$72.44
Gen-4 LS w/o D.O.D. Valley Gasket	C15025	\$38.00

Fuel Injector O-Ring Set		
Application	Part No.	Retail
Upper and Lower O-Rings	C15027	\$30.47

Exhaust Pipe Gaskets		
Application	Part No.	Retail
Graphite Exhaust Pipe	C15028	\$10.85
Metal Ring Exhaust Pipe	C15029	\$9.33

Cooling/Water Pump Gaskets		
Application	Part No.	Retail
Gen-3/4 LS V8 (pair) Molded	C5174	\$11.99
Gen-3/4 LS V8 (pair) .031" Fiber	C15032-031	\$6.14
Gen-3/4 LS Water Pump Backing O-ring	C15033	\$2.14
Gen-3/4 LS Coolant Bypass Seals	C15034	\$6.93

Knock Sensor Grommet Kit		
Application	Part No.	Retail
Gen-3 LS- 2 Pack	C15035	\$7.53

Exhaust Manifold Gaskets		
Application	Part No.	Retail
Gen-3/4 LS V8 - Round Port	C5818-030	\$43.85
Factory MAST Gen-3/4 LS V8 Cylinder Head	C15711-030	\$43.85

Throttle Body Gaskets		
Application	Part No.	Retail
97-05 5.7L	C5168	\$14.94
99-05 4.8/5.3/6.0L	C5169	\$14.94
2005 5.3/6.0L SUV	C15020	\$10.47
06-13 4.8/5.3/6.0/6.2L	C15021	\$17.04

Valve Stem Seals		
Application	Part No.	Retail
97-01 LS V8	3516PB-16	\$32.19
02-13 LS V8 - Hat Style	3256V-16	\$29.49

Rear Main Seal Kit		
Application	Part No.	Retail
Gen-3/4 LS V8	C5172	\$70.79

Timing Cover Set		
Application	Part No.	Retail
Gen-3/4 LS V8	C5056	\$45.45

Oil Pan Gasket Set		
Application	Part No.	Retail
Gen-3/4 LS V8 (not Vette)	C5173	\$30.45

Cam Plate Gasket		
Application	Part No.	Retail
With Recessed Bolts	C15031	\$32.75

Thermostat Seal		
Application	Part No.	Retail
Gen-3 LS V8 Thermostat Seal	C15036	\$7.62

Gasket Kits



To purchase a complete gasket kit order both top end and bottom end gasket kit

TOP END GASKET KITS

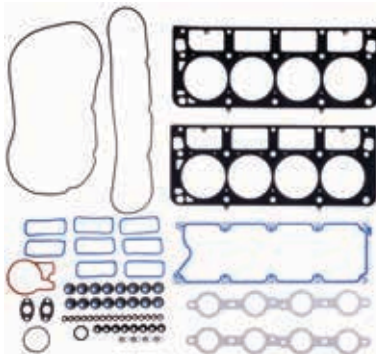

Application	Part No.	Retail
1997-05 LS1/LS6 5.7L (Car Only)	PRO1007T	\$282.15
LS3/L92 6.2L Carbureted 4.060" Bore	PRO1035T	\$221.75
1999-01 6.0L (Truck Only) 4.100" Bore	PRO1008T	\$249.69
2001-10 4.8/5.3L Truck/Van/SUV 3.840" Bore	PRO1040T	\$419.48
2014-19 5.3L L83 Truck/Van/SUV	PRO1050T	\$321.67
2001-07 6.0L Truck/Van/SUV 4.060" Bore	PRO1041T	\$307.11
2005-07 6.0L Truck/Van/SUV 4.100" Bore	PRO1037T	\$357.05
2007-10 6.0/6.2L Truck/Van/SUV 4.100" Bore	PRO1036T	\$399.49
2009-11 LS3 6.2L (Car Only)	PRO1043T	\$344.57
2014-18 6.2L L86 Truck/Van/SUV	PRO1051T	\$337.98

BOTTOM END GASKET KITS



Application	Part No.	Retail
4.8/5.3/5.7/6.0/6.2L LS V8 with flat mount Cam Plate Bolts	PRO1040B	\$195.04
4.8/5.3/5.7/6.0/6.2L LS V8 with recessed Cam Plate Bolts	PRO1036B	\$254.43



CHEVROLET / GM

LS7 7.0L V8

Head Gaskets

MLS Head Gaskets - Works With Aftermarket Sleeves Only

Bore	Thickness	Pkg Qty	Part No.	Retail
4.150"	.051"	1	C5889-051	\$107.27

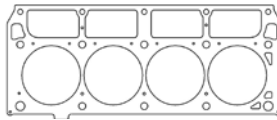

Additional thicknesses available
see pages 2 - 4

MLX Head Gasket

Bore	Thickness	Pkg Qty	Part No.	Retail
4.150"	.052"	1	C5030-052	\$164.92

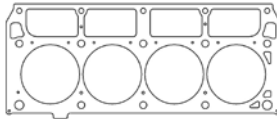

Individual Gaskets

Valve Cover Gasket (sold individually)

Application	Part No.	Retail
Gen-3/4 LS V8 - Center Bolt	C5170	\$15.44
Gen-3/4 Valve Cover Grommet Set	C15030	\$13.22

Intake Manifold Gaskets

Application	Part No.	Retail
LS7 2006-13 w/Carb Intake	C5167-060	\$31.12
Gen IV LS w/o D.O.D. Valley Gasket	C15025	\$38.00

Exhaust Manifold Gaskets

Application	Part No.	Retail
Gen-3/4 LS V8 - Round Port	C5818-030	\$43.85
Factory MAST Gen-3/4 LS V8 Cylinder Head	C15711-030	\$43.85

Valve Stem Seals

Application	Part No.	Retail
05-13 LS7 V8 - Hat Style	3256V-16	\$29.49

Timing Cover Set

Application	Part No.	Retail
Gen-3/4 LS V8	C5056	\$45.45

Fuel Injector O-Ring Set

Application	Part No.	Retail
Upper and Lower O-Rings	C15027	\$30.47

Cooling/Water Pump Gaskets

Application	Part No.	Retail
Gen-3/4 LS V8 (pair) Molded	C5174	\$11.99
Gen-3/4 LS V8 (pair) .031" Fiber	C15032-031	\$6.14
Gen-3/4 LS Water Pump Backing O-ring	C15033	\$2.14
Gen-3/4 LS Coolant Bypass Seals	C15034	\$6.93

Rear Main Seal Kit

Application	Part No.	Retail
Gen-3/4 LS V8	C5172	\$70.79

LS9/LSA 6.2L 2009-2013: 09-13 Corvette ZR1, 09-15 Cadillac CTS-V, 12-15 Camaro ZL1

Head Gaskets

MLX Head Gaskets - Right Side

Bore	Thickness	Pkg Qty	Part No.	Retail
4.100"	.051"	1	C5985-051	\$125.65

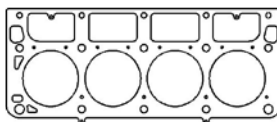

Additional thicknesses available
see pages 2 - 4

MLX Head Gaskets - Left Side

Bore	Thickness	Pkg Qty	Part No.	Retail
4.100"	.051"	1	C5986-051	\$125.65

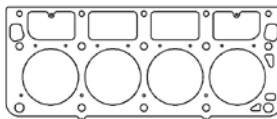

Individual Gaskets

Valve Cover Gasket (sold individually)

Application	Part No.	Retail
Gen-3/4 LS V8 - Center Bolt	C5170	\$15.44
Gen-3/4 Valve Cover Grommet Set	C15030	\$13.22

Valve Stem Seals

Application	Part No.	Retail
09-13 LS V8 - Hat Style	3256V-16	\$29.49

Exhaust Manifold Gaskets

Application	Part No.	Retail
Gen-3/4 LS V8 - Round Port	C5818-030	\$43.85
Factory MAST Gen-3/4 LS V8 Cylinder Head	C15711-030	\$43.85

Oil Pan Gasket Set

Application	Part No.	Retail
97-13 LS V8 (Pan to Block) Wet Sump	C5173	\$30.45

Timing Cover Set

Application	Part No.	Retail
Gen-3/4 LS V8	C5056	\$45.45

Intake Manifold Gaskets

Application	Part No.	Retail
Gen-4 LS V8 w/o D.O.D. Valley Gasket	C15025	\$38.00

Cooling/Water Pump Gaskets

Application	Part No.	Retail
Gen-3/4 LS V8 (pair) Molded	C5174	\$11.99
Gen-3/4 LS V8 (pair) .031" Fiber	C15032-031	\$6.14
Gen-3/4 LS Water Pump Backing O-ring	C15033	\$2.14
Gen-3/4 LS Coolant Bypass Seals	C15034	\$6.93

Rear Main Seal Kit

Application	Part No.	Retail
Gen-3/4 LS V8	C5172	\$70.79



CHEVROLET / GM

LSX RACE BLOCK 6-BOLT 1/2" and 3/8" Studs

Head Gaskets

MLX Head Gaskets - Right Side

Bore	Thickness	Pkg Qty	Part No.	Retail
4.165"	.052"	1	C15503-052	\$131.93
4.200"	.052"	1	C15362-052	\$131.93

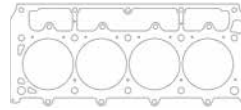

Additional thicknesses available
see pages 2 - 4

1/2" & 3/8" Stud Hole Combination

MLX Head Gaskets - Left Side

Bore	Thickness	Pkg Qty	Part No.	Retail
4.165"	.052"	1	C15502-052	\$131.93
4.200"	.052"	1	C15363-052	\$131.93

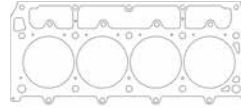

NEW!

DST Head Gaskets - Right Side

Bore	Thickness	Pkg Qty	Part No.	Retail
4.165"	.063"	1	C15743-063	\$313.95
4.165"	.071"	1	C15743-071	\$313.95
4.200"	.063"	1	C15744-063	\$313.95
4.200"	.071"	1	C15744-071	\$313.95

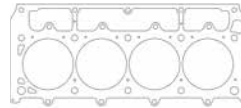

NEW!

DST Head Gaskets - Left Side

Bore	Thickness	Pkg Qty	Part No.	Retail
4.165"	.063"	1	C15742-063	\$313.95
4.165"	.071"	1	C15742-071	\$313.95
4.200"	.063"	1	C15745-063	\$313.95
4.200"	.071"	1	C15745-071	\$313.95

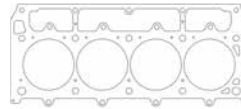

LSX RACE BLOCK 6-BOLT

Head Gaskets

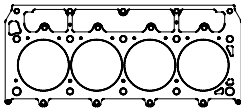

MLS Head Gaskets - Left Side

Bore	Thickness	Pkg Qty	Part No.	Retail
4.060"	.051"	1	C15526-051	\$97.72
4.125"	.051"	1	C5934-051	\$97.72
4.185"	.051"	1	C5936-051	\$97.72
4.200"	.051"	1	C15751-051	\$97.72

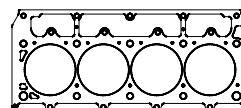

MLS Head Gaskets - Right Side

Bore	Thickness	Pkg Qty	Part No.	Retail
4.060"	.051"	1	C15527-051	\$97.72
4.125"	.051"	1	C5933-051	\$97.72
4.185"	.051"	1	C5935-051	\$97.72
4.200"	.051"	1	C15750-051	\$97.72

Additional thicknesses available
see pages 2 - 4

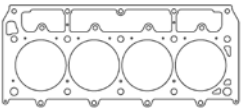

MLX Head Gaskets - Left Side

Bore	Thickness	Pkg Qty	Part No.	Retail
4.100"	.040"	1	C5076-040	\$125.65
4.165"	.040"	1	C5703-040	\$125.65
4.200"	.040"	1	C5078-040	\$125.65

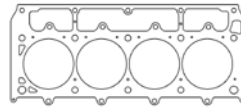

MLX Head Gaskets - Right Side

Bore	Thickness	Pkg Qty	Part No.	Retail
4.100"	.040"	1	C5075-040	\$125.65
4.165"	.040"	1	C5702-040	\$125.65
4.200"	.040"	1	C5077-040	\$125.65

NEW!

DST Head Gaskets - Left Side

Bore	Thickness	Pkg Qty	Part No.	Retail
4.165"	.063"	1	C15742-063	\$313.95
4.165"	.071"	1	C15742-071	\$313.95
4.200"	.063"	1	C15745-063	\$313.95
4.200"	.071"	1	C15745-071	\$313.95

NEW!

DST Head Gaskets - Right Side

Bore	Thickness	Pkg Qty	Part No.	Retail
4.165"	.063"	1	C15743-063	\$313.95
4.165"	.071"	1	C15743-071	\$313.95
4.200"	.063"	1	C15744-063	\$313.95
4.200"	.071"	1	C15744-071	\$313.95

See page 29 for additional gaskets

CHEVROLET / GM

LSX RACE BLOCK (continued)

Head Gaskets (continued)

Copper Head Gaskets - Right Side

Bore	Thickness	Pkg Qty	Part No.	Retail
4.100"	.043"	1	C15410-043	\$122.45

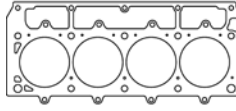

Additional thicknesses available
see pages 2 - 4

Copper Head Gaskets - Left Side

Bore	Thickness	Pkg Qty	Part No.	Retail
4.100"	.043"	1	C15409-043	\$122.45

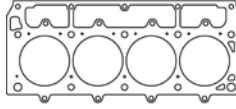

Individual Gaskets

Valve Cover Gasket (sold individually)

Application	Part No.	Retail
Gen-3/4 Valve Cover Grommet Set	C15030	\$13.22
Gen-3/4 LS V8 - Center Bolt	C5170	\$15.44

Intake Manifold Gaskets

Application	Part No.	Retail
LS7 2006-13 w/Carb Intake	C5167-060	\$31.12
LSX-DR Head - Lrg Port	C15037-060	\$33.86
Gen IV LS w/o D.O.D. Valley Gasket	C15025	\$38.00

Cooling/Water Pump Gaskets

Application	Part No.	Retail
Gen-3/4 LS V8 (pair) Molded	C5174	\$11.99
Gen-3/4 LS V8 (pair) .031" Fiber	C15032-031	\$6.14
Gen-3/4 LS Water Pump Backing O-ring	C15033	\$2.14
Gen-3/4 LS Coolant Bypass Seals	C15034	\$6.93

Exhaust Manifold Gaskets

Application	Part No.	Retail
LSX-DR .064" AM	C15038-064	\$36.33
2006-13 D-Port - MLS	C5073-030	\$41.48

Valve Stem Seals

Application	Part No.	Retail
09-13 LS V8 - Hat Style	3256V-16	\$29.49

Oil Pan Gasket Set

Application	Part No.	Retail
Gen-3/4 LS V8 (Pan to Block)	C5173	\$30.45

Timing Cover Set

Application	Part No.	Retail
Gen-3/4 LS V8	C5056	\$45.45

Gasket Kits



To purchase a complete gasket kit order both top end and bottom end gasket kit

TOP END GASKET KIT



Application	Part No.	Retail
LSX w/LS7 Carb Intake 4.125" Bore	PRO1025T	\$212.23

BOTTOM END GASKET KIT



Application	Part No.	Retail
LSX V8	PRO1025B	\$166.97

LS1 / LS6 5.7L, LS2 6.0L, & LS3 6.2L w/Darton M.I.D. Sleeves

Head Gaskets

MLS Head Gaskets

Bore	Thickness	Pkg Qty	Part No.	Retail
3.910"	.040"	1	C5788-040	\$107.27
4.125"	.040"	1	C5789-040	\$107.27
4.165"	.040"	1	C5790-040	\$107.27

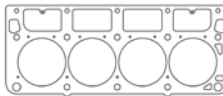

Additional thicknesses available
see pages 2 - 4



CHEVROLET / GM

L83 / 5.3L EcoTec3

Head Gaskets

MLX Head Gasket				
Bore	Thickness	Pkg Qty	Part No.	Retail
3.875"	.058"	1	C15426-058	\$128.10

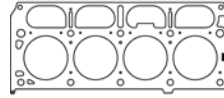

Additional thicknesses available
see pages 2 - 4

Individual Gaskets

Valve Cover Set		
Application	Part No.	Retail
2014+ L83 5.3L Valve Cover Set	C15438	\$34.65

Gasket Kits



TOP END GASKET KIT

To purchase a complete gasket kit order both top end and bottom end gasket kit

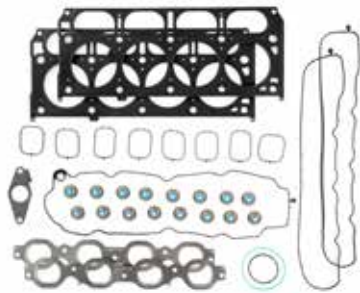

Application	Part No.	Retail
GM L83 Gen-5 Small Block V8 Top End	PRO1050T	\$321.67

LT1 / LT4 / L8T 6.2L V8 2014+UP

Head Gaskets

MLX Head Gaskets				
Bore	Thickness	Pkg Qty	Part No.	Retail
4.100"	.051"	1	C5038-051	\$125.65
4.150"	.051"	1	C15203-051	\$131.93
4.200"	.051"	1	C15202-051	\$131.93

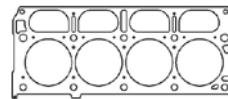

Additional thicknesses available
see pages 2 - 4

Individual Gaskets

Exhaust Manifold Gaskets		
Application	Part No.	Retail
2014+ 1.920" Port - .021" MLS	C5020-021	\$60.66

Valley Pan Gasket		
Application	Part No.	Retail
2014+ LT1/LT4 Valley Pan	C15437	\$18.09

Valve Cover Set		
Application	Part No.	Retail
2014+ LT1/LT4 Valve Cover Set	C15438	\$34.65

Intake Manifold Gaskets		
Application	Part No.	Retail
2014+ LT1 Set of 8	C15599	\$32.72

LT6 5.5L V8 2022+ Z06

Head Gaskets

NEW!

MLX Head Gaskets Right Hand Side				
Bore	Thickness	Pkg Qty	Part No.	Retail
4.165"	.041"	1	C15752-041	\$131.93

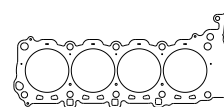

Additional thicknesses available
see pages 2 - 4

NEW!

MLX Head Gaskets Left Hand Side				
Bore	Thickness	Pkg Qty	Part No.	Retail
4.165"	.041"	1	C15753-041	\$131.93

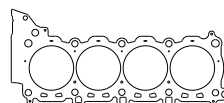



CHEVROLET / GM

LT-R / LTX 6-Bolt V8

Head Gaskets

MLX Head Gaskets - Left Side

Bore	Thickness	Pkg Qty	Part No.	Retail
4.150"	.052"	1	C15704-052	\$144.73

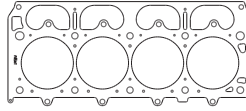

Additional thicknesses available
see pages 2 - 4

MLX Head Gaskets - Right Side

Bore	Thickness	Pkg Qty	Part No.	Retail
4.150"	.052"	1	C15703-052	\$144.73

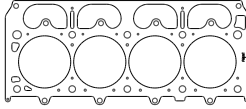

348ci 1958-61 / 409ci 1961-65 "W" V8

Head Gaskets

MLS Head Gaskets

Bore	Thickness	Pkg Qty	Part No.	Retail
4.200"	.040"	1	C5255-040	\$112.63
4.375"	.040"	1	C5256-040	\$112.63
4.437"	.040"	1	C5219-040	\$112.63

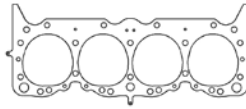

Additional thicknesses available
see pages 2 - 4

Individual Gaskets

Intake Manifold Gaskets

Application	Part No.	Retail
409ci V8 - .059" CFM	C15039-059	\$38.06
348-409ci V8 - .060" FC, Small Port	C15600-060	\$28.30

Exhaust Manifold Gasket

Application	Part No.	Retail
409ci V8 - .064" AM	C15040-064	\$38.06

Big Block V8 - Gen 4 1965-90 396, 402, 427, 454ci

Head Gaskets

MLS Head Gaskets

Bore	Thickness	Pkg Qty	Part No.	Retail
4.320"	.040"	1	C5816-040	\$109.94
4.375"	.040"	1	C5329-040	\$109.94
4.540"	.040"	1	C5330-040	\$109.94
4.630"	.040"	1	C5331-040	\$109.94

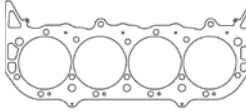

Additional thicknesses available
see pages 2 - 4

MLX Head Gaskets

Bore	Thickness	Pkg Qty	Part No.	Retail
4.560"	.032"	1	C15561-032	\$149.50
4.560"	.040"	1	C15561-040	\$149.50
4.560"	.052"	1	C15561-052	\$164.92

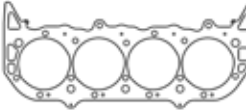

Copper Head Gaskets

Bore	Thickness	Pkg Qty	Part No.	Retail
4.320"	.043"	1	C15413-043	\$145.68
4.530"	.043"	1	C15414-043	\$145.68
4.630"	.043"	1	C15415-043	\$145.68

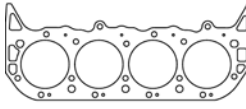

Individual Gaskets

Valve Cover Gasket (sold individually)

Application	Part No.	Retail
Molded Rubber .188"	C5975	\$25.98

Intake Manifold Gaskets

Application	Part No.	Retail
Rect Port 1.754" x 2.505" - .060" KF	C5649-060	\$33.73
Oval Port 1.848" x 2.042" - .060" KF	C15041-060	\$33.73

Exhaust Manifold Gaskets

Application	Part No.	Retail
1.85" x 1.90" Sq Port - MLS	C5897-030	\$50.77
1.920" Round Port - MLS	C5896-030	\$50.77
2.015" Round Port - MLS	C5349-030	\$50.77
2.130" Round Port - MLS	C5996-030	\$50.77
2.200" Round Port - MLS	C5350-030	\$50.77
2.265" Round Port - MLS	C5251-030	\$50.77

See page 32 for additional gaskets



CHEVROLET / GM

Big Block V8 - Gen 4 1965-90 396, 402, 427, 454ci (continued)

Individual Gaskets (continued)

Timing Cover Sets		
Application	Part No.	Retail
1965-95 BBC V8	C5057	\$21.78

Rear Main Seal Kit		
Application	Part No.	Retail
2pc 1965-90 - Silicone	C5086	\$22.91
2pc 1965-90 - Viton	C5682	\$35.65

Oil Pan Gasket Set		
Application	Part No.	Retail
4pc Kit	C5344	\$35.14
1 pc Molded Rubber	C15550	\$56.98

Cooling/Water Pump Gaskets		
Application	Part No.	Retail
Water Pump Mounting - Req 2	C5347-039	\$6.08
Water Outlet	C5346-047	\$1.30

Gasket Kits



To purchase a complete gasket kit order both top end and bottom end gasket kit

TOP END GASKET KIT

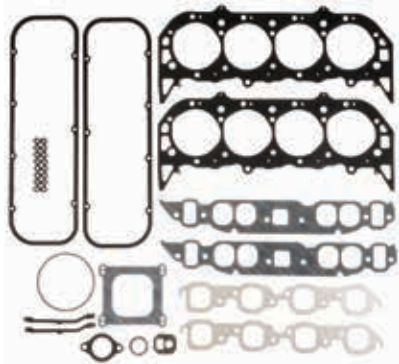

Application	Part No.	Retail
454ci 1970-85 4.275" Bore	PRO1005T	\$237.21

BOTTOM END GASKET KIT



Application	Part No.	Retail
Big Block Gen4	PRO1005B	\$61.45

Big Block V8 - Gen 5/6 1991-00 454, 502ci

Head Gaskets

MLS Head Gaskets				
Bore	Thickness	Pkg Qty	Part No.	Retail
4.320"	.040"	1	C5817-040	\$109.94
4.375"	.040"	1	C5332-040	\$109.94
4.540"	.040"	1	C5333-040	\$109.94
4.630"	.040"	1	C5334-040	\$109.94

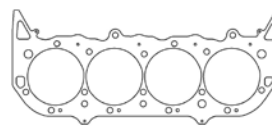

Additional thicknesses available see pages 2 - 4

MLX Head Gaskets				
Bore	Thickness	Pkg Qty	Part No.	Retail
4.560"	.032"	1	C15656-032	\$164.92
4.560"	.040"	1	C15656-040	\$164.92
4.560"	.052"	1	C15656-052	\$164.92

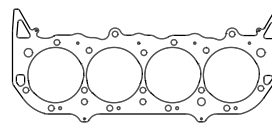

Individual Gaskets

Valve Cover Gasket (sold individually)		
Application	Part No.	Retail
Molded Rubber	C15423	\$16.28

Intake Manifold Gaskets		
Application	Part No.	Retail
Rect Port 1.754" x 2.505" - .060" KF	C5649-060	\$33.73
Oval Port 1.848" x 2.042" - .060" KF	C15041-060	\$33.73

Exhaust Manifold Gaskets		
Application	Part No.	Retail
1.85" x 1.90" Sq Port - MLS	C5897-030	\$50.77
1.920" Round Port - MLS	C5896-030	\$50.77
2.015" Round Port - MLS	C5349-030	\$50.77
2.130" Round Port - MLS	C5996-030	\$50.77
2.200" Round Port - MLS	C5350-030	\$50.77
2.265" Round Port - MLS	C5251-030	\$50.77

See page 33 for additional gaskets

CHEVROLET / GM

Big Block V8 - Gen 5/6 1991-00 454, 502ci (continued)

Individual Gaskets (continued)

Timing Cover Sets

Application	Part No.	Retail
1990-95 BBC V8	C5057	\$21.78
1996-00 BBC V8	C5058	\$19.47

Rear Main Seal Kit

Application	Part No.	Retail
1pc 1991-00 Gen 5/6 - SN	C5087	\$35.65

Cooling/Water Pump Gaskets

Application	Part No.	Retail
Water Pump Mounting - Req 2	C5347-039	\$6.08
Water Outlet	C5346-047	\$1.30

Oil Pan Gasket Set

Application	Part No.	Retail
1pc Molded Rubber	C15077	\$34.57

Gasket Kits



To purchase a complete gasket kit order both top end and bottom end gasket kit

TOP END GASKET KITS

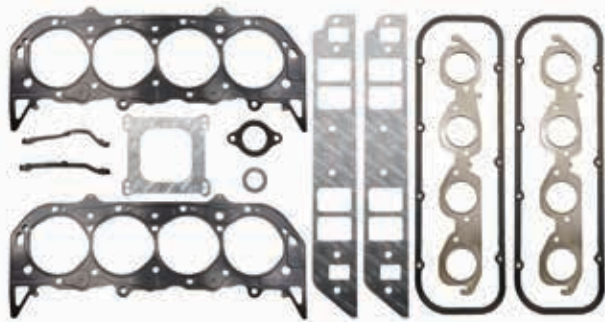

Application	Part No.	Retail
GM Gen-5/6 454 BB V8 W/Gen4 Heads	PRO1045T	\$242.41
GM Gen-5 L19 454 BB V8	PRO1047T	\$266.66
GM Gen-6 L21/29 454 Big Block V8	PRO1046T	\$278.78

BOTTOM END GASKET KITS



Application	Part No.	Retail
GM Gen-5 454 L19 BB V8	PRO1045B	\$72.71
GM Gen-6 L21/29/454/502 Big Block V8	PRO1046B	\$70.29

Big Block V8 - Aftermarket, Race, & Marine Blocks

Head Gaskets

MLS Head Gaskets - Mercury Gen 4/5/6 w/4 Bolts in Lifter Valley

Bore	Thickness	Pkg Qty	Part No.	Retail
4.500"	.051"	1	C5634-051	\$105.62
4.530"	.051"	1	C5635-051	\$105.62
4.580"	.051"	1	C5636-051	\$105.62
4.600"	.051"	1	C5637-051	\$105.62

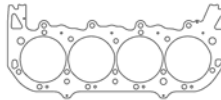

Additional thicknesses available
see pages 2 - 4

MLS Head Gaskets - Mercury 1050 Gen 4 w/2 Slotted Lifter Valley Bolts

Bore	Thickness	Pkg Qty	Part No.	Retail
4.500"	.051"	1	C5638-051	\$105.62
4.530"	.051"	1	C5639-051	\$105.62
4.580"	.051"	1	C5640-051	\$105.62
4.600"	.051"	1	C5641-051	\$105.62

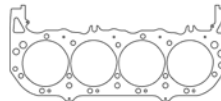

MLS Head Gaskets - Mercury Marine 525/625 Gen 6

Bore	Thickness	Pkg Qty	Part No.	Retail
4.470"	.040"	1	C5760-040	\$109.94

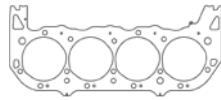

MLS Head Gaskets - Mercury Marine QC4v V8

Bore	Thickness	Pkg Qty	Part No.	Retail
116.5mm	.050"	1	C15665-050	\$197.21

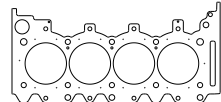

See page 34 for additional gaskets



CHEVROLET / GM

Big Block V8 - Aftermarket, Race, & Marine Blocks (continued)

Head Gaskets (continued)

MLS Head Gaskets - Mercury 8.1L 496 - Right Side

Bore	Thickness	Pkg Qty	Part No.	Retail
4.280"	.051"	1	C5761-051	\$115.44
4.350"	.051"	1	C5762-051	\$115.44
4.450"	.051"	1	C5763-051	\$115.44

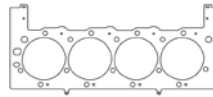

Additional thicknesses available
see pages 2 - 4

MLS Head Gaskets - Mercury 8.1L 496 - Left Side

Bore	Thickness	Pkg Qty	Part No.	Retail
4.280"	.051"	1	C5764-051	\$115.44
4.350"	.051"	1	C5765-051	\$115.44
4.450"	.051"	1	C5766-051	\$115.44

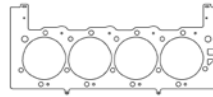

MLS Head Gaskets - Aftermarket Heads Undersized Water Ports to Allow for Customization

Bore	Thickness	Pkg Qty	Part No.	Retail
4.310"	.040"	1	C5432-040	\$100.59
4.570"	.040"	1	C5433-040	\$100.59
4.630"	.040"	1	C5434-040	\$100.59

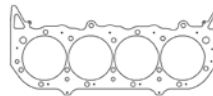

MLS Head Gaskets - Brodix DN-9

Bore	Thickness	Pkg Qty	Part No.	Retail
4.620"	.051"	1	C15270-051	\$105.62

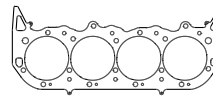

NEW!

MLS Head Gaskets - Gen 4/5/6 Round Bore w/ Round Embossments For All Aftermarket Iron & Aluminum Blocks (MAX Bore 4.680")

Bore	Thickness	Pkg Qty	Part No.	Retail
4.640"	.040"	1	C15756-040	\$109.94
4.680"	.040"	1	C15680-040	\$109.94

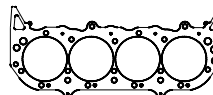

MLS Head Gaskets - ZL1 1969 7.0L 427ci Aluminum - Round Bore w/Round Embossments

Bore	Thickness	Pkg Qty	Part No.	Retail
4.250"	.040"	1	C5746-040	\$109.94
4.300"	.040"	1	C5747-040	\$109.94
4.375"	.040"	1	C5759-040	\$109.94

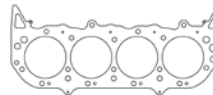

Individual Gaskets

Valve Cover Gasket (sold individually)

Application	Part No.	Retail
Molded Rubber .188"	C5975	\$25.98
Brodix SR-20 FML .094" FIBER W/ STEEL	C15460	\$25.99
Brodix DN-9 .125" Fiber, Pair	C15268-125	\$98.12

Exhaust Manifold Gaskets

Application	Part No.	Retail
Brodix Big Brodie - .064" AM	C5429-064	\$25.11
Brodix Big Duke - .064" AM	C5418-064	\$25.11
Brodix DN-9 .060" HTS	C15272-060	\$29.75
Mercury 525/625 EFI - MLS	C15364-030	\$53.33
Mercury 1050 - MLS	C5820-051	\$80.34

Intake Manifold Gaskets

Application	Part No.	Retail
Brodix SR-20 -.060KF	C15459-060	\$33.87
Brodix Big Brodie Oval - .060" KF	C5430-060	\$29.76
Brodix Big Brodie Rectangle-.060" KF	C5428-060	\$29.76
Brodix Big Duke - .060" KF	C5419-060	\$29.76
Brodix DN-9 .060" KF	C15271-060	\$33.87
Mercury 1050 - MLS	C5821-051	\$84.37

Timing Cover Sets

Application	Part No.	Retail
1965-95 BBC V8	C5057	\$21.78
1996-00 BBC V8	C5058	\$19.47

Rear Main Seal Kits

Application	Part No.	Retail
2pc 1965-90 - Silicone	C5086	\$22.91
2pc 1965-90 - SN	C5682	\$35.65
1pc 1991-00 Gen 5/6 - SN	C5087	\$35.65

Oil Pan Gasket Set

Application	Part No.	Retail
4pc Kit 1965-90	C5344	\$35.14
4pc Kit Bolt Holes@Mains	C5254	\$38.01
1pc Molded Rubber 91-00	C15077	\$34.57

Cooling/Water Pump Gaskets

Application	Part No.	Retail
Water Pump Mounting - Req 2	C5347-039	\$6.08
Water Outlet	C5346-047	\$1.30

CHEVROLET / GM

Pro Stock Racing V8

Head Gaskets

MLS Head Gaskets - DRCE-2 4.900" Bore Centers 500ci

Bore	Thickness	Pkg Qty	Part No.	Retail
4.675"	.051"	1	C5449-051	\$149.23
4.700"	.051"	1	C5450-051	\$149.23
4.780"	.051"	1	C5451-051	\$149.23

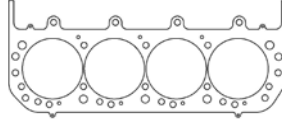

Additional thicknesses available
see pages 2 - 4

MLS Head Gaskets - DRCE-3 4.900" Bore Centers 500ci

Bore	Thickness	Pkg Qty	Part No.	Retail
4.675"	.051"	1	C5796-051	\$149.23
4.700"	.051"	1	C5797-051	\$149.23
4.780"	.051"	1	C5798-051	\$149.23

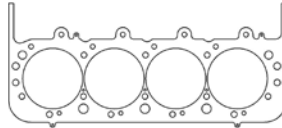

MLS Head Gasket - IHRA 5.00" Bore Centers 800ci

Bore	Thickness	Pkg Qty	Part No.	Retail
4.755"	.040"	1	C5850-040	\$142.12

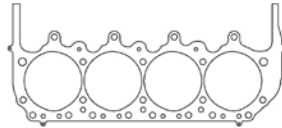

MLX Head Gasket - 5.20" Bore Centers

Bore	Thickness	Pkg Qty	Part No.	Retail
4.860"	.040"	1	C5013-040	\$126.49

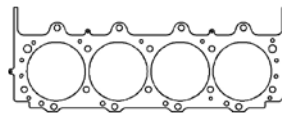

MLX Head Gaskets - BRODIX 5.0 Bore Space Big Block V8

Bore	Thickness	Pkg Qty	Part No.	Retail
4.700"	.041"	1	C15397-041	\$149.23
4.760"	.041"	1	C15398-041	\$149.23
4.795"	.041"	1	C15399-041	\$149.23

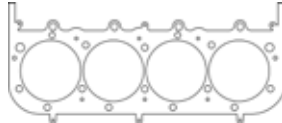

6.5L Diesel V8 1992-00

Head Gaskets

MLS Head Gaskets

Bore	Thickness	Pkg Qty	Part No.	Retail
4.100"	.043"	1	C15682-043	\$154.86

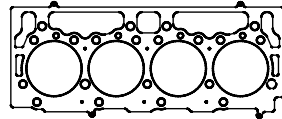

Additional thicknesses available
see pages 2 - 4

6.6L Duramax Diesel V8 2001-2016

Head Gaskets

MLX Head Gaskets - Right Side

Bore	Thickness	Pkg Qty	Part No.	Retail
4.130"	.053"	1	C15375-053	\$216.98
4.130"	.062"	1	C15375-062	\$216.98

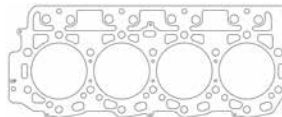

Additional thicknesses available
see pages 2 - 4

MLX Head Gaskets - Left Side

Bore	Thickness	Pkg Qty	Part No.	Retail
4.130"	.053"	1	C15376-053	\$216.98
4.130"	.062"	1	C15376-062	\$216.98

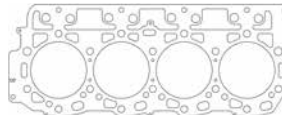

See page 36 for additional gaskets



CHEVROLET / GM

6.6L Duramax Diesel V8 2001-2016 (continued)

Head Gaskets

MLS Head Gaskets - Right Side

Bore	Thickness	Pkg Qty	Part No.	Retail
4.100"	.040"	1	C5882-040	\$163.65

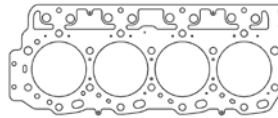

MLS Head Gaskets - Left Side

Bore	Thickness	Pkg Qty	Part No.	Retail
4.100"	.040"	1	C5883-040	\$163.65

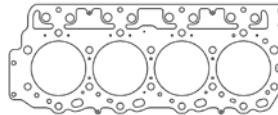

Individual Gaskets

Exhaust Manifold Gaskets

Application	Part No.	Retail
2001-16 8mm Bolts - MLS, Pair	C15042-040	\$61.91

Rear Main Seal Kit

Application	Part No.	Retail
2001-07	C15044	\$74.14

Timing Cover Set

Application	Part No.	Retail
2001-15	C15045	\$51.72

Oil Pan Gasket Set

Application	Part No.	Retail
2001-10 17 Bolt - .060" KF	C15043	\$21.15
2011-16 18 Bolt - .060" KF	C15723	\$20.14

Oil Cooler Gaskets

Application	Part No.	Retail
2001-16 Duramax Oil Cooler Outlet	C15263	\$6.55
2001-16 Duramax Oil Cooler Inlet	C15264	\$6.55

Gasket Kits



To purchase a complete gasket kit order both top end and bottom end gasket kit

TOP END GASKET KITS

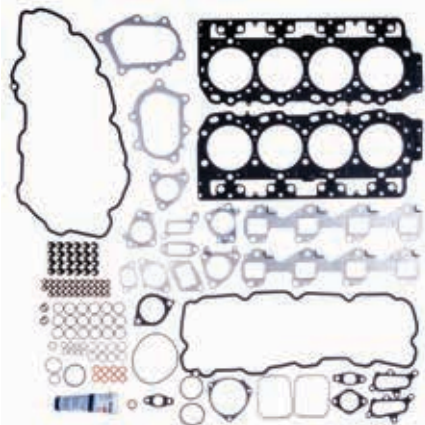

Application	Part No.	Retail
6.6L Duramax 2001-04	PRO3008T	\$539.09
6.6L Duramax 2005-07	PRO3009T	\$662.75
6.6L Duramax LML/LGH 2011-16	PRO3012T	\$660.45

BOTTOM END GASKET KITS



Application	Part No.	Retail
6.6L Duramax 2001-07	PRO3008B	\$205.22
6.6L Duramax 2007-10 LMM/LGH	PRO3011B	\$214.77
6.6L Duramax 2011-16 LML	PRO3012B	\$220.89

6.6L L5P Gen 1 Duramax Diesel V8 2017-2023

Head Gaskets

NEW!

MLX Head Gasket 2017-23 L5P Gen 1

Bore	Thickness	Pkg Qty	Part No.	Retail
4.161"	.060"	1	C15177-060	\$166.31

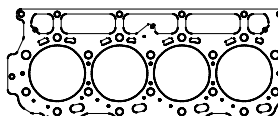

Additional thicknesses available see pages 2 - 4

CHRYSLER / DODGE

2.0L DOHC 4cyl ECC / 420A 1995-99

Head Gaskets

MLS Head Gaskets

Bore	Thickness	Pkg Qty	Part No.	Retail
87.5mm	.040"	1	C5497-040	\$102.61
88.5mm	.040"	1	C5498-040	\$102.61

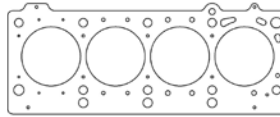

Additional thicknesses available
see pages 2 - 4

Individual Gaskets

Valve Cover Gasket Set

Application	Part No.	Retail
1995-99 2.0L DOHC	C15046	\$52.45

Intake Manifold Gaskets

Application	Part No.	Retail
Intake Manifold Gasket - .060" AFM	C15047-060	\$13.08
Intake Plenum Gasket - .031" Fiber	C15048-031	\$5.41

Exhaust Manifold Gasket

Application	Part No.	Retail
2.040" X 1.100" Port - MLS	C4161-030	\$27.22

Throttle Body Gasket

Application	Part No.	Retail
Molded Rubber	C15051	\$4.37

Valve Stem Seal Set (16 Pack)

Application	Part No.	Retail
5 x 10.8 x 18.3 x 16.9 - Hat Style	3180V-16	\$39.39

Cam Seal Set

Application	Part No.	Retail
Pair - 48 x 35 x 7	C15049	\$16.28

Front Crank Seal Set

Application	Part No.	Retail
1995-99 2.0L DOHC	C15053	\$24.96

Oil Pan Gasket Set

Application	Part No.	Retail
Molded Rubber	C15050	\$34.61

Rear Main Seal

Application	Part No.	Retail
1995-99 2.0L DOHC	C15052	\$15.93

Gasket Kits



To purchase a complete gasket kit order both top end and bottom end gasket kit

TOP END GASKET KIT

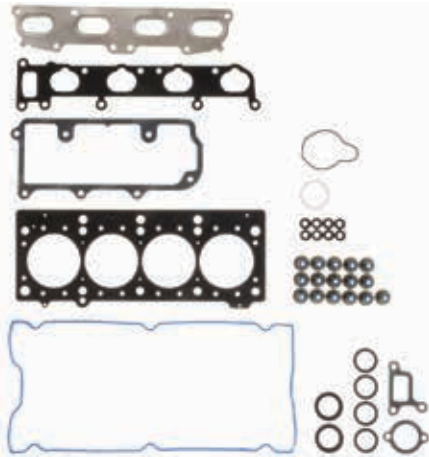

Application	Part No.	Retail
1995-99 420A 2.0L DOHC 88.5mm Bore	PRO2005T	\$185.35

BOTTOM END GASKET KIT



Application	Part No.	Retail
1995-99 420A 2.0L DOHC	PRO2005B	\$88.67



CHRYSLER / DODGE

2.4L DOHC Turbo 4cyl 2003-05 Neon SRT4, 2002-10 PT Cruiser, 2003-06 Jeep Wrangler

Head Gaskets

MLS Head Gaskets

Bore	Thickness	Pkg Qty	Part No.	Retail
87.5mm	.030"	1	C4548-030	\$112.63
90mm	.030"	1	C4549-030	\$112.63

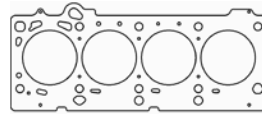

Additional thicknesses available
see pages 2 - 4

MLX Head Gaskets

Bore	Thickness	Pkg Qty	Part No.	Retail
88.5mm	.040"	1	C15449-040	\$126.12

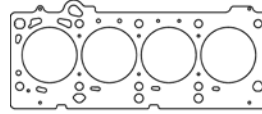

2.4L DOHC Turbo 4cyl ED4 World Engine 2008-09 Dodge Caliber

Head Gaskets

MLX Head Gaskets

Bore	Thickness	Pkg Qty	Part No.	Retail
89.45mm	.036"	1	C15627-036	\$110.88

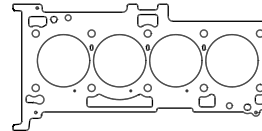

Additional thicknesses available
see pages 2 - 4

Individual Gaskets

Exhaust Manifold Gasket

Application	Part No.	Retail
2.4L ED4 World Engine	C15195-090	\$56.37

Gasket Kits



To purchase a complete gasket kit order both top end and bottom end gasket kit

TOP END GASKET KIT



Application	Part No.	Retail
2.4L ED4 World Engine Top End Gasket Kit	PRO1044T	\$277.58



CHRYSLER / DODGE

2.2L DOHC 4cyl 1991-93

Head Gaskets

MLS Head Gaskets

Bore	Thickness	Pkg Qty	Part No.	Retail
89.5mm	.066"	1	C5733-066	\$156.31

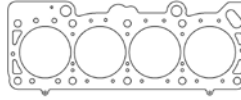

Additional thicknesses available
see pages 2 - 4

2.2L SOHC 4cyl 1982-90, 2.5L SOHC 4cyl 1986-95

Head Gaskets

MLS Head Gaskets

Bore	Thickness	Pkg Qty	Part No.	Retail
89.5mm	.066"	1	C5734-066	\$156.31

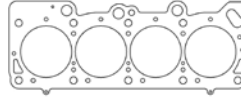

Additional thicknesses available
see pages 2 - 4

3.5L SOHC V6 1999-10, 4.0L SOHC V6 2007-11

Head Gaskets

MLS Head Gasket - Right Side

Bore	Thickness	Pkg Qty	Part No.	Retail
96.5mm	.075"	1	C5015-075	\$91.05

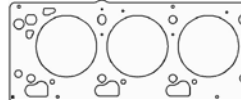

Additional thicknesses available
see pages 2 - 4

MLS Head Gasket - Left Side

Bore	Thickness	Pkg Qty	Part No.	Retail
96.5mm	.075"	1	C5016-075	\$91.05

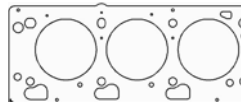

3.6L DOHC V6 2011-20 Pentastar "ERB"

Head Gaskets

MLS HP Head Gaskets - Right Side

Bore	Thickness	Pkg Qty	Part No.	Retail
3.850"	.032"	1	C15658-032	\$91.05

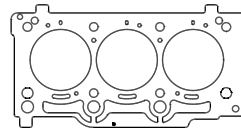

Additional thicknesses available
see pages 2 - 4

MLS HP Head Gaskets - Left Side

Bore	Thickness	Pkg Qty	Part No.	Retail
3.850"	.032"	1	C15659-032	\$91.05

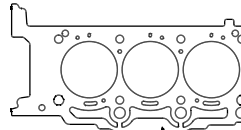

3.7L SOHC V6 2002-13 PowerTech "EKG"

Head Gaskets

MLS Head Gasket

Bore	Thickness	Pkg Qty	Part No.	Retail
95mm	.030"	1	C5794-030	\$112.63

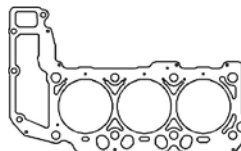

Additional thicknesses available
see pages 2 - 4



CHRYSLER / DODGE

4.0L Inline 6 242ci 1987-2006: 87-01 Cherokee, 93-04 Grand Cherokee, 87-90 Wagoneer, 87-92 Comanche, 91-06 Wrangler

Head Gaskets

MLS Head Gaskets

Bore	Thickness	Pkg Qty	Part No.	Retail
3.950	.050"	1	C5987-050	\$137.55
4.000	.050"	1	C5988-050	\$137.55
4.060	.050"	1	C5989-050	\$137.55

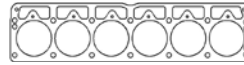

Additional thicknesses available
see pages 2 - 4

Individual Gaskets

Timing Cover Set

Application	Part No.	Retail
3.8/4.0/4.2L I6 1965-2006	C5047	\$20.58

Oil Pan Gasket

Application	Part No.	Retail
3.8/4.0/4.2L I6 1971-2006, 1-Piece Rubber	C15710	\$40.95

4.7L SOHC V8 1999-13 PowerTech

Head Gaskets

MLS Head Gaskets - 1999-07

Bore	Thickness	Pkg Qty	Part No.	Retail
93mm	.030"	1	C5213-030	\$107.27
95mm	.030"	1	C5214-030	\$107.27

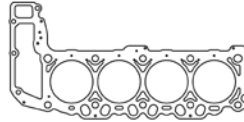

Additional thicknesses available
see pages 2 - 4

MLS Head Gasket - 2008-13

Bore	Thickness	Pkg Qty	Part No.	Retail
94mm	.030"	1	C5803-030	\$107.27

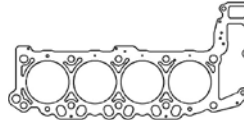

Individual Gaskets

Cooling/Water Pump Gaskets

Application	Part No.	Retail
Thermostat Gasket 1999-13 3.7L V6/4.7L V8	C15168	\$4.31

Polyspherical 318 V8 1957-67 (A Engine)

Head Gaskets

MLS Head Gaskets

Bore	Thickness	Pkg Qty	Part No.	Retail
4.030"	.040"	1	C15296-040	\$112.53

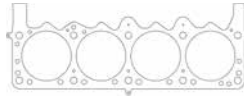

Additional thicknesses available
see pages 2 - 4

5.2L & 5.9L Magnum V8 1992-03

Head Gaskets

MLS Head Gaskets

Bore	Thickness	Pkg Qty	Part No.	Retail
4.040"	.040"	1	C15535-040	\$97.72
4.040"	.051"	1	C15535-051	\$102.61
4.040"	.060"	1	C15535-060	\$134.49

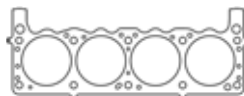

Additional thicknesses available
see pages 2 - 4

Individual Gaskets

Valve Cover Gasket (sold individually)

Application	Part No.	Retail
10 Bolt - .047" KF	C5557-047	\$33.73

Oil Pan Gasket Set

Application	Part No.	Retail
4pc Set	C5560-094	\$37.16

See page 41 for additional gaskets



CHRYSLER / DODGE

5.2L & 5.9L Magnum V8 1992-03 (continued)

Individual Gaskets (continued)

Intake Manifold Gaskets		
Application	Part No.	Retail
2.150" x 1.140" Port - .047" KF	C5555-047	\$22.44
End Rail Gaskets	C5556-047	\$8.42

Exhaust Gaskets		
Application	Part No.	Retail
1.195" x 1.675" - .064" AM	C5558-064	\$28.14

Cooling/Water Pump Gaskets		
Application	Part No.	Retail
Water Pump Cover Gasket	C5561-018	\$12.64
Thermostat Gasket	C5562-018	\$1.88

Timing Cover Sets		
Application	Part No.	Retail
1992-96	C5059	\$25.98
1997-03	C5060	\$25.98

Rear Main Seal		
Application	Part No.	Retail
2pc SN	C5564	\$37.94

Fuel Pump Gasket		
Application	Part No.	Retail
Fuel Pump to Block	C5642-031	\$2.60

318/340/360ci V8 "LA" 1964-92

Head Gaskets

MLS Head Gaskets				
Bore	Thickness	Pkg Qty	Part No.	Retail
4.040"	.040"	1	C5633-040	\$97.72
4.080"	.040"	1	C5622-040	\$97.72
4.125"	.040"	1	C5457-040	\$97.72
4.180"	.040"	1	C5456-040	\$97.72

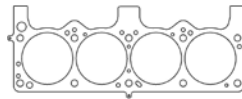

Additional thicknesses available
see pages 2 - 4

MLS Head Gaskets - w/318A Engine Quest or Edelbrock Heads				
Bore	Thickness	Pkg Qty	Part No.	Retail
4.040"	.040"	1	C5916-040	\$107.27
4.080"	.040"	1	C5917-040	\$107.27
4.125"	.040"	1	C5918-040	\$107.27
4.180"	.040"	1	C5919-040	\$107.27

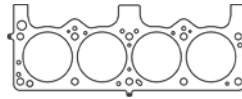

Copper Head Gaskets				
Bore	Thickness	Pkg Qty	Part No.	Retail
4.200"	.043"	1	C15416-043	\$128.57

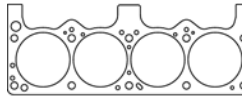

Individual Gaskets

Valve Cover Gasket (sold individually)		
Application	Part No.	Retail
Molded Rubber	C15468	\$34.01
5 Bolt - .094" KF	C5623-094	\$22.44

Intake Manifold Gaskets		
Application	Part No.	Retail
1.170" x 2.300" Rectangle Port - .060" KF	C5624-060	\$33.73
End Rail Gaskets	C5625-060	\$8.42

Exhaust Manifold Gaskets		
Application	Part No.	Retail
1.205" x 1.845" - .064" AM	C5628-064	\$26.71
1.055" x 1.700", 1.303" x 1.700" Irregular Port -MLS	C5901-030	\$50.77

Timing Cover Set		
Application	Part No.	Retail
1964-91 Set	C5061	\$32.46

Oil Pan Gasket Sets		
Application	Part No.	Retail
4pc 318/340ci V8	C5627-094	\$37.16
4pc 360ci V8	C5508-094	\$37.16

Rear Main Seal Kit		
Application	Part No.	Retail
273/318/340ci 2pc - SN	C5683	\$38.73
360ci 2pc - SN	C5684	\$43.00

Cooling / Water Pump Gaskets		
Application	Part No.	Retail
Water Pump Gasket	C15054-060	\$13.39
Thermostat Gasket	C5574-018	\$1.30

Fuel Pump Gasket		
Application	Part No.	Retail
Fuel Pump to Block	C5642-031	\$2.60

See page 42 StreetPro gasket kits



CHRYSLER / DODGE

318/340/360ci V8 "LA" 1964-92 (continued)

Gasket Kits



To purchase a complete gasket kit order both top end and bottom end gasket kit

TOP END GASKET KIT

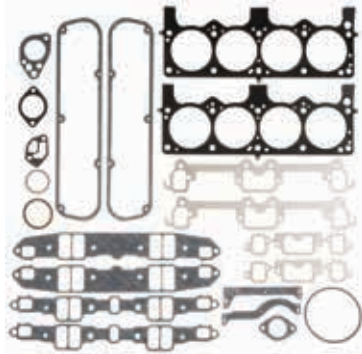

Application	Part No.	Retail
1968-89 318, 1968-73 340, 1971-80 360 4.080" Bore	PRO1000T	\$232.21

BOTTOM END GASKET KIT

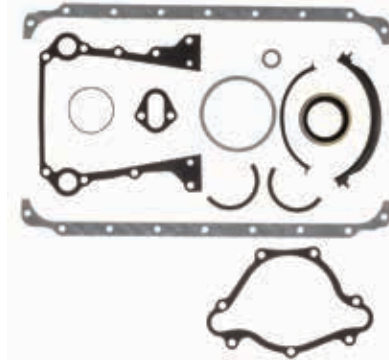

Application	Part No.	Retail
360ci V8	PRO1000B	\$80.14
318/340ci V8	PRO1002B	\$80.14

5.7L Hemi V8 2003-Present

Head Gaskets

MLX Head Gaskets - Right Side

Bore	Thickness	Pkg Qty	Part No.	Retail
4.000"	.040"	1	C15315-040	\$131.28

MLX Head Gaskets - Left Side

Bore	Thickness	Pkg Qty	Part No.	Retail
4.000"	.040"	1	C15316-040	\$131.28

MLS Head Gaskets - Right Side

Bore	Thickness	Pkg Qty	Part No.	Retail
3.950"	.027"	1	C5467-027	\$107.27
4.100"	.027"	1	C5749-027	\$107.27
4.100"	.040"	1	C5749-040	\$107.27

MLS Head Gaskets - Left Side

Bore	Thickness	Pkg Qty	Part No.	Retail
3.950"	.027"	1	C5468-027	\$107.27
4.100"	.027"	1	C5750-027	\$107.27
4.100"	.040"	1	C5750-040	\$107.27

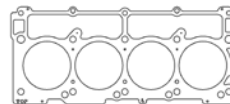
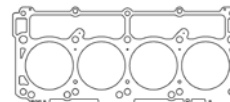
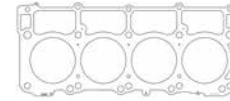
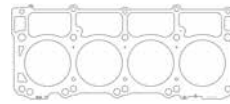

Additional thicknesses available
see pages 2 - 4

Individual Gaskets

Valve Cover Gasket Kit

Application	Part No.	Retail
Valve Covers and Spark Plug Tubes Kit	C5193PR	\$37.79

Intake Manifold Gasket Set

Application	Part No.	Retail
2003-2008 5.7L Hemi (Molded Rubber Set of 8)	C5196	\$24.01
2009-Up 5.7L Hemi (Molded Rubber Set of 8)	C15755	\$21.80

Throttle Body Gasket

Application	Part No.	Retail
Molded Rubber	C5199	\$12.11

Thermostat Housing Gasket

Application	Part No.	Retail
Molded Rubber	C5198	\$4.05

Oil Pan Gasket Set

Application	Part No.	Retail
Integrated Windage Tray	C5201	\$82.26

Timing Cover Set

Application	Part No.	Retail
2003-Up 5.7L Hemi	C5202	\$48.06

See page 43 for additional gaskets



CHRYSLER / DODGE

5.7L Hemi V8 2003-Present (continued)

Individual Gaskets (continued)

Exhaust Gaskets		
Application	Part No.	Retail
MLS Exhaust Gaskets - Pair 2003-08	C5854-030	\$44.19

Valve Stem Seal Set (16 Pack)		
Application	Part No.	Retail
Hat Style - SN Steel Body	3260V-16	\$77.90

Rear Main Seal Kit		
Application	Part No.	Retail
Seal and Housing Gasket	C5203	\$46.62

Water Pump Gasket		
Application	Part No.	Retail
Molded Rubber	C5204	\$8.69

Gasket Kits



To purchase a complete gasket kit order both top end and bottom end gasket kit

TOP END GASKET KIT

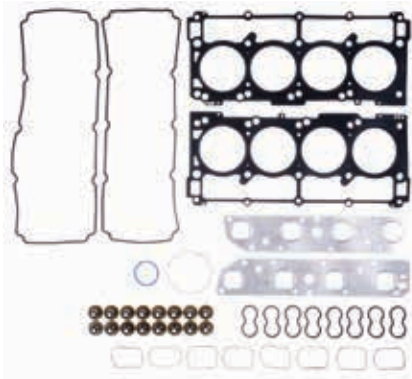

Application	Part No.	Retail
2003-08 5.7L V8 3.950" Bore	PRO1022T	\$294.63

BOTTOM END GASKET KIT

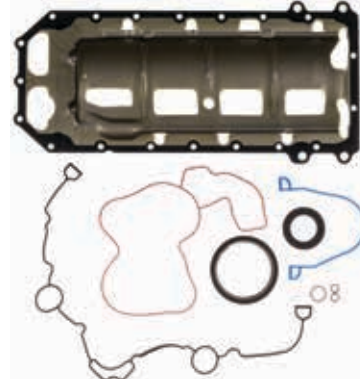

Application	Part No.	Retail
2003-08 5.7L V8	PRO1022B	\$201.63

6.1L Hemi V8 2005-10

Head Gaskets

MLS Head Gaskets				
Bore	Thickness	Pkg Qty	Part No.	Retail
4.100"	.040"	1	C5876-040	\$107.27
4.125"	.036"	1	C5441-036	\$107.27
4.125"	.040"	1	C5441-040	\$107.27
4.185"	.040"	1	C5042-040	\$107.27
4.250"	.040"	1	C5890-040	\$107.27

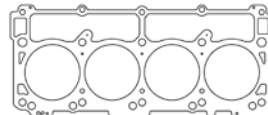

Additional thicknesses available
see pages 2 - 4

MLX Head Gasket				
Bore	Thickness	Pkg Qty	Part No.	Retail
4.100"	.040"	1	C15149-040	\$137.84
4.100"	.044"	1	C15149-044	\$137.84
4.100"	.054"	1	C15149-054	\$137.84
4.100"	.058"	1	C15149-058	\$137.84

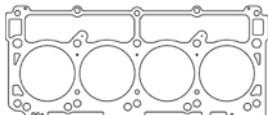

MLS Head Gaskets - Aluminum Sleeved Block				
Bore	Thickness	Pkg Qty	Part No.	Retail
4.055"	.040"	1	C5525-040	\$107.27
4.125"	.070"	1	C5526-070	\$156.31
4.125"	.075"	1	C5526-075	\$156.31
4.125"	.040"	1	C5526-040	\$107.27
4.185"	.040"	1	C5527-040	\$107.27

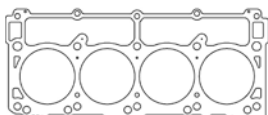

See page 44 for additional gaskets



CHRYSLER / DODGE

6.1L Hemi V8 2005-10 (continued)

Individual Gaskets

Valve Cover Gasket Kit		
Application	Part No.	Retail
Valve Covers and Spark Plug Tubes Kit	C5193PR	\$37.79

Oil Pan Gasket Set		
Application	Part No.	Retail
Intergrated Windage Tray	C5529	\$103.16

Throttle Body Gasket		
Application	Part No.	Retail
Molded Rubber	C5199	\$12.11

Exhaust Gaskets		
Application	Part No.	Retail
MLS Exhaust Gaskets - Pair	C5872-030	\$47.05

Valve Stem Seal Set (16 Pack)		
Application	Part No.	Retail
Hat Style - SN Steel Body - EXH	3260V-16	\$77.90
Hat Style - SN Steel Body - INT	3261V-16	\$50.68

Thermostat Housing Gasket		
Application	Part No.	Retail
Molded Rubber	C5198	\$4.05

Intake Manifold Gasket Set		
Application	Part No.	Retail
Chrysler 6.1L 2005-2010 Hemi Intake Manifold Gasket Set	C5197	\$41.48

Timing Cover Set		
Application	Part No.	Retail
2005-10 6.1L Hemi	C5202	\$48.06

Rear Main Seal Kit		
Application	Part No.	Retail
Seal and Housing Gasket	C5203	\$46.62

Water Pump Gasket		
Application	Part No.	Retail
Molded Rubber	C5204	\$8.69

Gasket Kits



To purchase a complete gasket kit order both top end and bottom end gasket kit

TOP END GASKET KIT

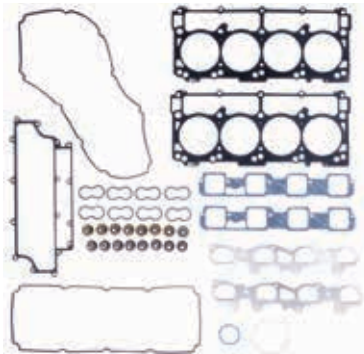

Application	Part No.	Retail
2005-10 6.1L Hemi V8 4.125" Bore	PRO1023T	\$315.25

BOTTOM END GASKET KIT

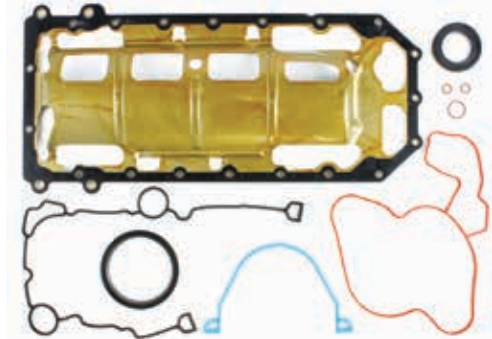

Application	Part No.	Retail
2005-10 6.1L Hemi V8	PRO1023B	\$226.11

6.2L Hemi V8 2015-Present "Hellcat"

Head Gaskets

MLX Head Gaskets - Right Side

Bore	Thickness	Pkg Qty	Part No.	Retail
4.150"	.040"	1	C15292-040	\$131.28
4.150"	.054"	1	C15292-054	\$137.84

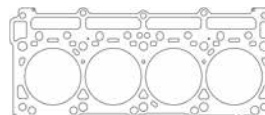

Additional thicknesses available see pages 2 - 4

MLX Head Gaskets - Left Side

Bore	Thickness	Pkg Qty	Part No.	Retail
4.150"	.040"	1	C15293-040	\$131.28
4.150"	.054"	1	C15293-054	\$137.84

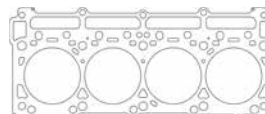

See page 45 for additional gaskets

CHRYSLER / DODGE

6.2L Hemi V8 2015-Present "Hellcat" (continued)

Head Gaskets

NEW!

DST Head Gaskets - Right Side

Bore	Thickness	Pkg Qty	Part No.	Retail
4.150"	.063"	1	C15732-063	\$313.95
4.150"	.071"	1	C15732-071	\$313.95

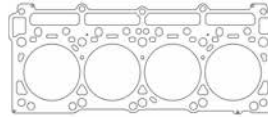

Additional thicknesses available
see pages 2 - 4

NEW!

DST Head Gaskets - Left Side

Bore	Thickness	Pkg Qty	Part No.	Retail
4.150"	.063"	1	C15731-063	\$313.95
4.150"	.071"	1	C15731-071	\$313.95

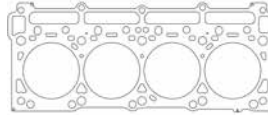

Individual Gaskets

Intake Manifold Gaskets

Application	Part No.	Retail
2015-Up 6.2L Hemi Blower Snout Gasket	C15276	\$13.67
2015-Up 6.2L Hemi Supercharger Lid Gasket	C15628-060	\$41.46
2015-Up 6.2L Hemi Hellcat Intake Manifold Gasket (Pair)	C15553-060	\$54.06

Valve Cover Gasket Kit

Application	Part No.	Retail
Valve Covers and Spark Plug Tubes Kit	C5193PR	\$37.79

Timing Cover Gasket

Application	Part No.	Retail
2015-Up 6.2L Hemi	C5202	\$48.06

6.4L Hemi V8 2011-Present "Apache"

Head Gaskets

MLS Head Gasket - Right Side

Bore	Thickness	Pkg Qty	Part No.	Retail
4.120"	.040"	1	C5026-040	\$107.27

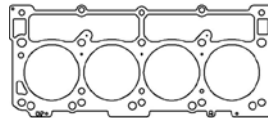

Additional thicknesses available
see pages 2 - 4

MLS Head Gasket - Left Side

Bore	Thickness	Pkg Qty	Part No.	Retail
4.120"	.040"	1	C5027-040	\$107.27

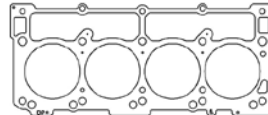

MLX Head Gasket - Right Side

Bore	Thickness	Pkg Qty	Part No.	Retail
4.150"	.040"	1	C15172-040	\$131.28
4.150"	.054"	1	C15172-054	\$137.84

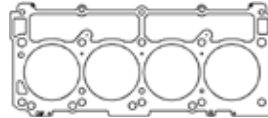

MLX Head Gasket - Left Side

Bore	Thickness	Pkg Qty	Part No.	Retail
4.150"	.040"	1	C15173-040	\$131.28
4.150"	.054"	1	C15173-054	\$137.84

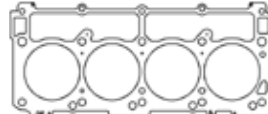

Individual Gaskets

Exhaust Manifold Gaskets

Application	Part No.	Retail
2011-Up 6.4L Hemi - Pair	C15642-090	\$112.73
2014-2021 6.4L Hemi - Heavy Duty RHS	C15671-060	\$124.93
2014-2021 6.4L Hemi - Heavy Duty LHS	C15672-060	\$124.93
2014-2021 6.4L Hemi - Mid Duty RHS	C15673-090	\$101.49
2014-2021 6.4L Hemi - Mid Duty LHS	C15674-090	\$101.49

Timing Cover Set

Application	Part No.	Retail
2011-Up 6.4L Hemi	C5202	\$48.06

Intake Gasket Set

Application	Part No.	Retail
2011-Up 6.4L Hemi (Molded Rubber Set of 8)	C15755	\$21.80

Valve Cover Gasket Kit

Application	Part No.	Retail
Valve Covers and Spark Plug Tubes Kit	C5193PR	\$37.79

See page 46 for StreetPro gasket kits

CHRYSLER / DODGE

6.4L Hemi V8 2011-Present "Apache" (continued)

Gasket Kits



To purchase a complete gasket kit order both top end and bottom end gasket kit

TOP END GASKET KIT

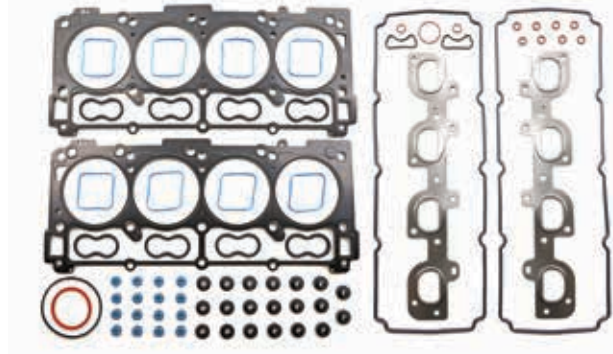

Application	Part No.	Retail
2011-Up Chrysler 6.4L Apache Gen-3 Hemi	PRO1048T	\$351.50

BOTTOM END GASKET KIT

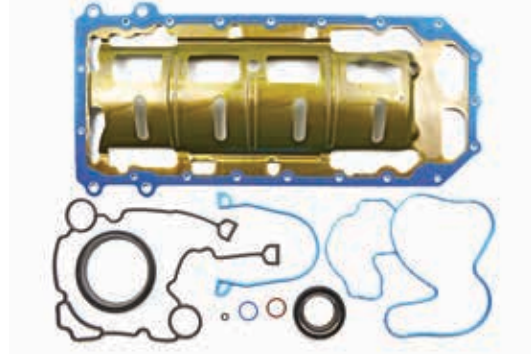

Application	Part No.	Retail
2011-Up Chrysler 6.4L Apache Gen-3 Hemi	PRO1048B	\$192.73

7.0L Hemi V8 2016-Present "Drag Pak"

Head Gaskets

MLX Head Gaskets - Right Side

Bore	Thickness	Pkg Qty	Part No.	Retail
4.200"	.054"	1	C15391-054	\$131.93

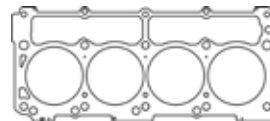

Additional thicknesses available
see pages 2 - 4

MLX Head Gaskets - Left Side

Bore	Thickness	Pkg Qty	Part No.	Retail
4.200"	.054"	1	C15392-054	\$131.93

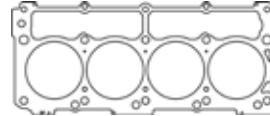

NEW!

DST Head Gaskets - Right Side

Bore	Thickness	Pkg Qty	Part No.	Retail
4.180"	.063"	1	C15734-063	313.95
4.180"	.071"	1	C15734-071	313.95

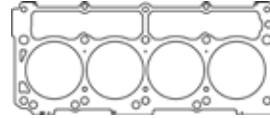

NEW!

DST Head Gaskets - Left Side

Bore	Thickness	Pkg Qty	Part No.	Retail
4.180"	.063"	1	C15733-063	313.95
4.180"	.071"	1	C15733-071	313.95

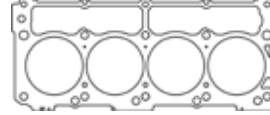

Individual Gaskets

Valve Cover Gasket Kit

Application	Part No.	Retail
Valve Covers and Spark Plug Tubes Kit	C5193PR	\$37.79



CHRYSLER / DODGE

DART Hemi Gen3 Iron Eagle Block

Head Gaskets

MLX Head Gaskets - Right Side

Bore	Thickness	Pkg Qty	Part No.	Retail
4.000"	.040"	1	C15718-040	\$137.84
4.000"	.054"	1	C15718-054	\$144.73
4.100"	.040"	1	C15716-040	\$137.84
4.100"	.054"	1	C15716-054	\$144.73
4.150"	.040"	1	C15714-040	\$137.84
4.150"	.054"	1	C15714-054	\$144.73
4.200"	.040"	1	C15758-040	\$137.84
4.200"	.040"	1	C15758-054	\$144.73
4.275"	.040"	1	C15712-040	\$137.84
4.275"	.054"	1	C15712-054	\$144.73

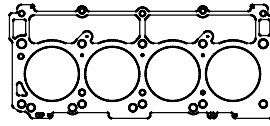

Additional thicknesses available
see pages 2 - 4

MLX Head Gaskets - Left Side

Bore	Thickness	Pkg Qty	Part No.	Retail
4.000"	.040"	1	C15719-040	\$137.84
4.000"	.054"	1	C15719-054	\$144.73
4.100"	.040"	1	C15717-040	\$137.84
4.100"	.054"	1	C15717-054	\$144.73
4.150"	.040"	1	C15715-040	\$137.84
4.150"	.054"	1	C15715-054	\$144.73
4.200"	.040"	1	C15757-040	\$137.84
4.200"	.040"	1	C15757-054	\$144.73
4.275"	.054"	1	C15713-054	\$137.84
4.275"	.054"	1	C15713-054	\$144.73

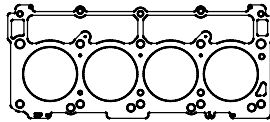

NEW!

DST Head Gaskets - Left Side

Bore	Thickness	Pkg Qty	Part No.	Retail
4.150"	.063"	1	C15738-063	\$313.95
4.150"	.071"	1	C15738-071	\$313.95
4.275"	.063"	1	C15736-063	\$313.95
4.275"	.071"	1	C15736-071	\$313.95

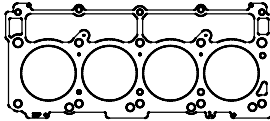

NEW!

DST Head Gaskets - Right Side

Bore	Thickness	Pkg Qty	Part No.	Retail
4.150"	.063"	1	C15737-063	\$313.95
4.150"	.071"	1	C15737-071	\$313.95
4.275"	.063"	1	C15735-063	\$313.95
4.275"	.071"	1	C15735-071	\$313.95

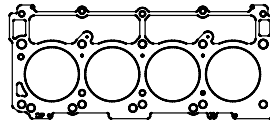

Small Block V8 - A8 Sprint & A4 Midget

Head Gaskets

MLS Head Gaskets - A8 Sprint Block

Bore	Thickness	Pkg Qty	Part No.	Retail
4.165"	.040"	1	C5828-040	\$97.72
4.200"	.040"	1	C5829-040	\$97.72
4.250"	.040"	1	C5830-040	\$97.72

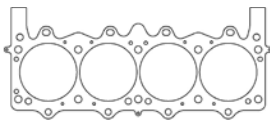

Additional thicknesses available
see pages 2 - 4

MLS Head Gaskets - A4 Midget Block

Bore	Thickness	Pkg Qty	Part No.	Retail
4.165"	.040"	1	C5831-040	\$97.72
4.200"	.040"	1	C5832-040	\$97.72

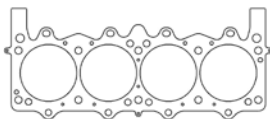

Individual Gaskets

Valve Cover Gasket (sold individually)

Application	Part No.	Retail
Midget & Sprint Head	C5784-060	\$19.02

Oil Pan Gasket Set

Application	Part No.	Retail
Midget Block - .060" AFM	C5596-060	\$29.47

Intake Manifold Gaskets

Application	Part No.	Retail
A4 Midget & A8 Sprint Intake Gasket, 2 Pack	C5590	\$22.44



CHRYSLER / DODGE

Small Block V8 - R3 Block w/W2, W7, W8, or W9 Heads

Head Gaskets

MLS Head Gaskets - R3 Block w/W2 Heads				
Bore	Thickness	Pkg Qty	Part No.	Retail
4.100"	.040"	1	C5567-040	\$97.72
4.200"	.040"	1	C5466-040	\$97.72

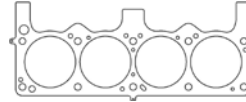

Additional thicknesses available
see pages 2 - 4

MLS Head Gaskets - R3 Block w/W7, W8, W9 Heads				
Bore	Thickness	Pkg Qty	Part No.	Retail
4.060"	.040"	1	C5579-040	\$97.72
4.100"	.040"	1	C5580-040	\$97.72
4.165"	.040"	1	C5581-040	\$97.72
4.185"	.040"	1	C5582-040	\$97.72

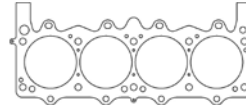

Individual Gaskets

Valve Cover Gaskets (sold individually)		
Application	Part No.	Retail
W2/W5/W7/W9 Heads	C5568-094	\$22.44
W8 Heads	C5592-094	\$18.28

Thermostat Gasket		
Application	Part No.	Retail
R3 Block	C5574-018	\$1.30

Intake Manifold Gaskets		
Application	Part No.	Retail
W2 Heads 1.35" x 2.07"	C5569-060	\$22.44
W7/W8/W9 Heads 1.45" x 2.20"	C5586-031	\$22.44
W9 Heads 1.391" x 2.193"	C15709-060	\$17.41
End Rail Gaskets	C5625-060	\$8.42

Oil Pan Gasket		
Application	Part No.	Retail
R3 Block - Rails Only	C5575-094	\$27.58

Exhaust Gaskets		
Application	Part No.	Retail
W2 Heads 1.47" x 1.45"	C5571-064	\$25.29
W7/W8/W9 Heads D-Port	C5593-064	\$26.71

Timing Cover Gasket		
Application	Part No.	Retail
R3 Block - .018" AFM	C5576-018	\$16.85

Fuel Pump Gasket		
Application	Part No.	Retail
R3 Block - .031" Fiber	C5642-031	\$2.60

Water Pump Gasket		
Application	Part No.	Retail
R3 Block	C5573-018	\$10.29

Small Block V8 - R4 Block w/P5 Heads

Head Gaskets

MLS Head Gaskets				
Bore	Thickness	Pkg Qty	Part No.	Retail
4.200"	.040"	1	C5801-040	\$107.27
4.250"	.040"	1	C5800-040	\$107.27

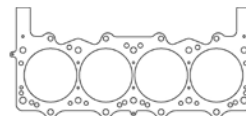

Additional thicknesses available
see pages 2 - 4

Small Block V8 - R6 Race Block

Head Gaskets

MLX Head Gasket - Right Side				
Bore	Thickness	Pkg Qty	Part No.	Retail
4.220"	.040"	1	C5670-040	\$126.49

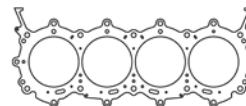

Additional thicknesses available
see pages 2 - 4

MLX Head Gasket - Left Side				
Bore	Thickness	Pkg Qty	Part No.	Retail
4.220"	.040"	1	C5671-040	\$126.49

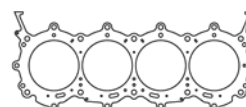

CHRYSLER / DODGE

Big Block Wedge 361, 383, 400, 413, 426, & 440ci V8

Head Gaskets

MLS Head Gaskets

Bore	Thickness	Pkg Qty	Part No.	Retail
4.250"	.040"	1	C5459-040	\$107.27
4.350"	.040"	1	C5460-040	\$107.27
4.380"	.040"	1	C5461-040	\$107.27
4.410"	.040"	1	C5462-040	\$107.27
4.500"	.040"	1	C5464-040	\$107.27
4.600"	.040"	1	C5799-040	\$107.27

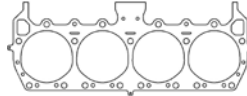

Additional thicknesses available
see pages 2 - 4

MLX Head Gaskets

Bore	Thickness	Pkg Qty	Part No.	Retail
4.500"	.040"	1	C15562-040	\$125.65

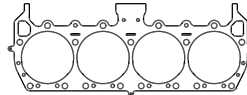

Copper Head Gaskets

Bore	Thickness	Pkg Qty	Part No.	Retail
4.400"	.043"	1	C15417-043	\$143.67

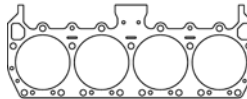

Individual Gaskets

Valve Cover Gasket (sold individually)

Application	Part No.	Retail
Molded Rubber	C5983	\$25.98

Intake Manifold Gaskets

Application	Part No.	Retail
1.229" x 2.310" Rectangle Port - .060" KF	C5611-060	\$22.44
End Rail Gaskets	C5612-060	\$9.11

Exhaust Gaskets

Application	Part No.	Retail
1.85" x 1.35" - .064" AM	C5619-064	\$26.71
1.780" x 1.460" Rectangle Port - .030" MLS	C5902-030	\$54.94

Thermostat Gasket

Application	Part No.	Retail
Big Block Wedge V8	C5616-018	\$1.88

Fuel Pump Gasket

Application	Part No.	Retail
Fuel Pump to Block	C5642-031	\$2.60

Oil Pan Gasket

Application	Part No.	Retail
Big Block Wedge V8-.060"AFM	C5617-060	\$18.28

Water Pump Gaskets

Application	Part No.	Retail
Pump to Block - Pair	C5615-032	\$12.64

Timing Cover Gasket Set

Application	Part No.	Retail
Big Block Wedge V8	C5062	\$32.46

Rear Main Seal Kit

Application	Part No.	Retail
2pc SN	C5686	\$40.69

Gasket Kits

To purchase a complete gasket kit order both top end and bottom end gasket kit

TOP END GASKET KIT

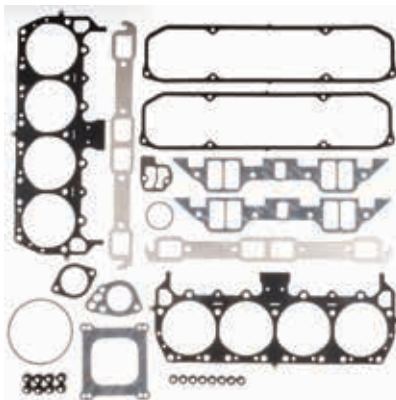

Application	Part No.	Retail
Big Block Wedge V8 4.410" Bore	PRO1001T	\$232.21

BOTTOM END GASKET KIT

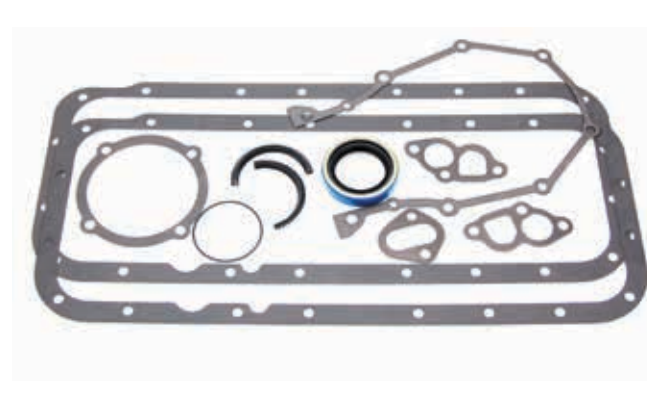

Application	Part No.	Retail
Big Block Wedge V8	PRO1001B	\$88.16



CHRYSLER / DODGE

392 Hemi V8 1957-58

Head Gaskets

MLS Head Gaskets				
Bore	Thickness	Pkg Qty	Part No.	Retail
4.000"	.040"	1	C5210-045	\$112.63
4.100"	.040"	1	C5211-045	\$112.63

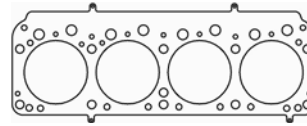

Additional thicknesses available
see pages 2 - 4

Copper Head Gaskets				
Bore	Thickness	Pkg Qty	Part No.	Retail
4.060"	.043"	1	C15418-043	\$128.57

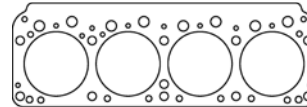

Individual Gaskets

Valve Cover Gaskets		
Application	Part No.	Retail
392 Hemi - 188" ML (pair)	C5236-188	\$51.95

Oil Pan Gasket Set		
Application	Part No.	Retail
1958-59 4pc Set	C15055	\$43.67

Intake Manifold Gasket Set		
Application	Part No.	Retail
Includes Valley Gasket	C5237	\$72.69

Distributor Gasket		
Application	Part No.	Retail
392 Hemi - .031" Fiber	C5239-031	\$1.93

Exhaust Gaskets		
Application	Part No.	Retail
1957-58 - .064" AM	C5238-064	\$40.93

Timing Cover Gasket Set		
Application	Part No.	Retail
1955-59 Early Hemi	C5063	\$34.31

Cooling/Water Pump Gaskets		
Application	Part No.	Retail
Pump to Block - 4 Pack	C5228-060	\$9.08
Water Outlet	C5229-060	\$4.62
Water Inlet	C5230-032	\$1.88

Carburetor Gasket Kits		
Application	Part No.	Retail
392 Hemi 2bbl Kit	C5240	\$9.84
392 Hemi 4bbl Kit	C5241	\$16.65

Gasket Kits



To purchase a complete gasket kit order both top end and bottom end gasket kit

TOP END GASKET KIT

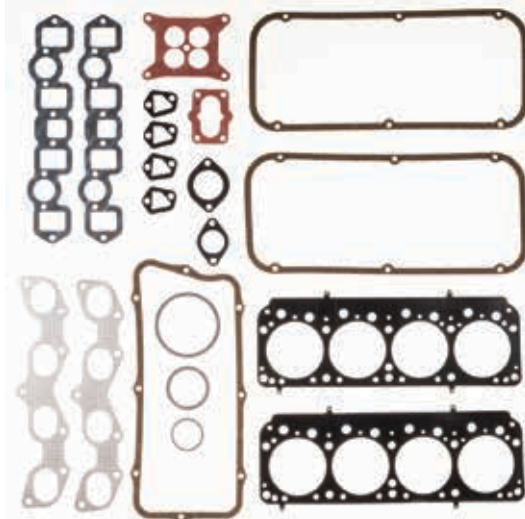

Application	Part No.	Retail
392 Hemi V8 1957-58 4.100" Bore	PRO1028T	\$212.23

BOTTOM END GASKET KIT

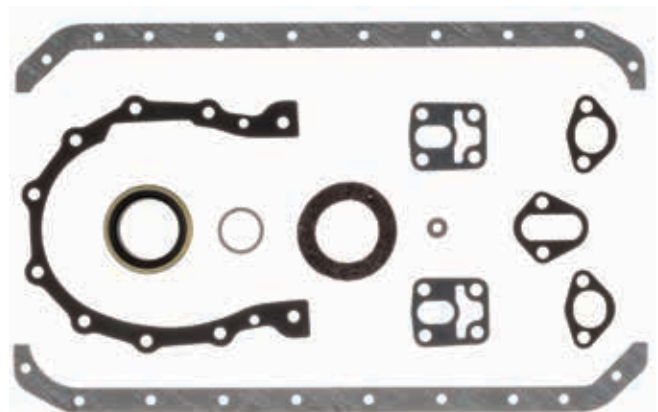

Application	Part No.	Retail
392 Hemi V8 1957-58	PRO1028B	\$88.16



CHRYSLER / DODGE

426 Hemi 1966 & Later

Head Gaskets

MLS Head Gaskets (Gasket bores .060" larger than listed)

Bore	Thickness	Pkg Qty	Part No.	Retail
4.250"	.040"	1	C5445-040	\$107.27
4.280"	.040"	1	C5454-040	\$107.27
4.310"	.040"	1	C5455-040	\$107.27
4.375"	.040"	1	C5446-040	\$107.27
4.500"	.040"	1	C5447-040	\$107.27

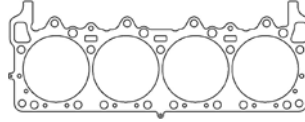

Additional thicknesses available
see pages 2 - 4

Copper Head Gaskets

Bore	Thickness	Pkg Qty	Part No.	Retail
4.320"	.043"	1	C15419-043	\$143.67

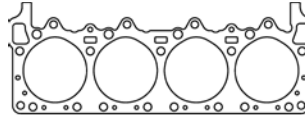

Individual Gaskets

Valve Cover Gasket (sold individually)

Application	Part No.	Retail
Molded Rubber	C5976	\$41.95

Intake Manifold Gaskets

Application	Part No.	Retail
1.856" x 2.009" Rectangle Port - .047" KF	C5598-047	\$22.44

Exhaust Gaskets

Application	Part No.	Retail
1.844" x 1.890" Rectangle Port - .030" MLS	C5965-030	\$46.94

Cooling / Water Pump Gaskets

Application	Part No.	Retail
Pump to Block - Pair	C5601-018	\$12.64
Pump to Housing	C5602-032	\$12.64
Thermostat Gasket	C5603-018	\$1.88

Rear Main Seal Kit

Application	Part No.	Retail
2pc SN	C5686	\$40.69

Oil Pump Gasket

Application	Part No.	Retail
426 Hemi	C5604-032	\$8.01

Oil Pan Gasket

Application	Part No.	Retail
426 Hemi - .060" AFM	C5606-060	\$29.00

Fuel Pump Gasket

Application	Part No.	Retail
Fuel Pump to Block	C5642-031	\$2.60

Distributor Gasket

Application	Part No.	Retail
426 Hemi	C5607-060	\$1.49

Timing Cover Gasket Set

Application	Part No.	Retail
426 Hemi	C5062	\$32.46

Gasket Kits



To purchase a complete gasket kit order both top end and bottom end gasket kit

TOP END GASKET KIT

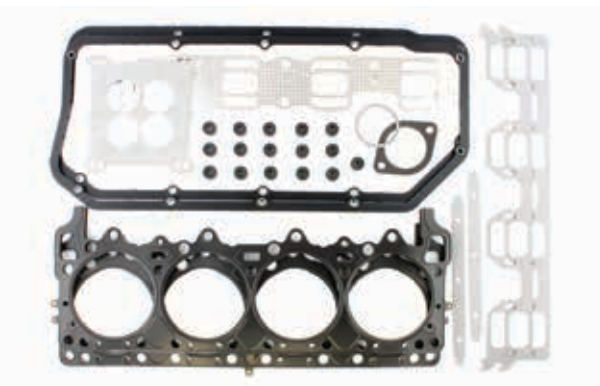

Application	Part No.	Retail
426 Hemi 7.0L 1966-71 4.100" Bore	PRO1021T	\$207.24

BOTTOM END GASKET KIT



Application	Part No.	Retail
426 Hemi 7.0L 1966-71	PRO1021B	\$101.51



CHRYSLER / DODGE

8.0L V10 1992-Early 96 (Gen 1 Viper)

Head Gaskets

MLS Head Gaskets

Bore	Thickness	Pkg Qty	Part No.	Retail
4.030"	.051"	1	C5113-051	\$237.25
4.165"	.051"	1	C5114-051	\$237.25

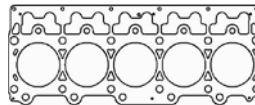

Additional thicknesses available
see pages 2 - 4

Individual Gaskets

Intake Manifold Gaskets

Application	Part No.	Retail
1992-1996 Gen 1 - .039" Fiber	C5827-039	\$25.34

Exhaust Manifold Gaskets

Application	Part No.	Retail
1992-96 Gen 1 - .030" MLS	C5679-030	\$38.01

8.0 / 8.3L V10 Late 1996-07 (Gen 2/3 Viper)

Head Gaskets

MLS Head Gaskets

Bore	Thickness	Pkg Qty	Part No.	Retail
4.060"	.051"	1	C5814-051	\$149.23
4.125"	.051"	1	C5815-051	\$149.23
4.165"	.051"	1	C5816-051	\$149.23

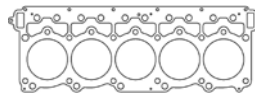

Additional thicknesses available
see pages 2 - 4

MLX Head Gaskets w/1/2" Studs

Bore	Thickness	Pkg Qty	Part No.	Retail
4.125"	.054"	1	C5585-054	\$220.11

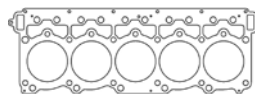

MLX Head Gaskets w/9/16" Studs

Bore	Thickness	Pkg Qty	Part No.	Retail
4.125"	.054"	1	C5487-054	\$220.11

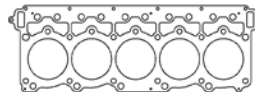

Individual Gaskets

Intake Manifold Gasket

Application	Part No.	Retail
1996-2002 Gen 2 - .039" Fiber	C5827-039	\$25.34

Exhaust Manifold Gaskets

Application	Part No.	Retail
1996-03 Gen 2 - .020" MLS	C5825-020	\$38.01
2004-07 Gen 3 - .030" MLS	C5865-030	\$38.01

Water Pump Gasket

Application	Part No.	Retail
1996-02 Gen 2 - .032" AFM	C15582	\$17.38

Oil Filter Adapter Gasket

Application	Part No.	Retail
1996-02 Gen 2 - .032" AFM	C15583	\$7.86

Timing Cover Gasket

Application	Part No.	Retail
1996-02 Gen 2 - .032" AFM	C15581	\$21.96

Oil Pan Gasket

Application	Part No.	Retail
1996-02 Gen 2 - .225" 3 Layer AFM	C15507	\$225.57

8.4L V10 2008-10, (Gen 4 Viper)

Head Gaskets

MLS Head Gasket

Bore	Thickness	Pkg Qty	Part No.	Retail
4.125"	.045"	1	C5107-045	\$149.23

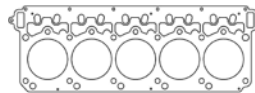

Additional thicknesses available
see pages 2 - 4

MLX Head Gasket w/9/16" Studs

Bore	Thickness	Pkg Qty	Part No.	Retail
4.125"	.054"	1	C5504-054	\$220.11

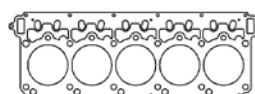

Individual Gaskets

Exhaust Manifold Gasket Set

Application	Part No.	Retail
2008-2010 Gen-4 MLS	C15150-040	\$61.88



CHRYSLER / DODGE

8.4L V10 2013-17 (Gen 5 Viper)

Head Gaskets

MLS Head Gaskets - Left Side

Bore	Thickness	Pkg Qty	Part No.	Retail
4.125"	.040"	1	C15377-040	\$149.23

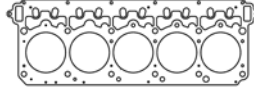

Additional thicknesses available
see pages 2 - 4

MLS Head Gaskets - Right Side

Bore	Thickness	Pkg Qty	Part No.	Retail
4.125"	.040"	1	C15378-040	\$149.23

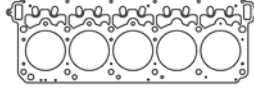

MLX Head Gaskets - Left Side

Bore	Thickness	Pkg Qty	Part No.	Retail
4.125"	.040"	1	C15431-040	\$184.80
4.125"	.049"	1	C15431-049	\$220.11
4.125"	.052"	1	C15431-052	\$220.11

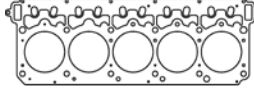

MLX Head Gaskets - Right Side

Bore	Thickness	Pkg Qty	Part No.	Retail
4.125"	.040"	1	C15432-040	\$184.80
4.125"	.049"	1	C15432-049	\$220.11
4.125"	.052"	1	C15432-052	\$220.11

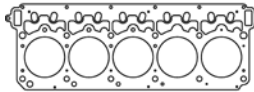

Individual Gaskets

Exhaust Manifold Gasket Set

Application	Part No.	Retail
2013-2017 Gen-5 MLS	C15150-040	\$61.88

Pro Stock Hemi 500ci V8

Head Gaskets

MLS Head Gaskets - Gen1 Hemi 99

Bore	Thickness	Pkg Qty	Part No.	Retail
4.660"	.051"	1	C5444-051	\$149.23
4.685"	.051"	1	C5443-051	\$149.23
4.700"	.051"	1	C5442-051	\$149.23
4.720"	.051"	1	C5438-051	\$149.23

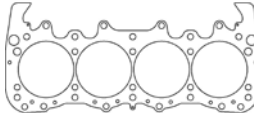

Additional thicknesses available
see pages 2 - 4

MLS Head Gaskets - Gen2 "DPS2"

Bore	Thickness	Pkg Qty	Part No.	Retail
4.750"	.050"	1	C5045-050	\$184.80

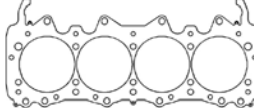

CUMMINS

3.9L 4BT Diesel 4cyl 1983+

Head Gasket

MLX Head Gasket

Bore	Thickness	Pkg Qty	Part No.	Retail
4.100"	.061"	1	C5591-061	\$129.92

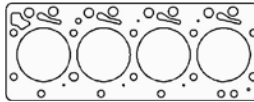

Additional thicknesses available
see pages 2 - 4

Individual Gaskets

Valve Cover Gasket Set

Application	Part No.	Retail
3.9L 4BT	C15056	\$25.98

Intake Manifold Gaskets

Application	Part No.	Retail
3.9L 4BT	C15057	\$12.50

Thermostat Housing Seal

Application	Part No.	Retail
3.9L 4BT	C15059	\$9.03

Oil Pan Gasket

Application	Part No.	Retail
3.9L 4BT - .031" Fiber	C15060	\$35.96

See page 54 for additional gaskets



CUMMINS

3.9L 4BT Diesel 4cyl 1983+ (continued)

Individual Gaskets (continued)

Exhaust Manifold Gaskets Set		
Application	Part No.	Retail
3.9L 4BT - 4 Pack	C15058	\$26.13

Valve Stem Seal		
Application	Part No.	Retail
8x12.3x12x17 Viton - Need 8	3164V	\$2.20

Timing Cover Seal		
Application	Part No.	Retail
3.9L 4BT	C15063	\$91.29

Water Pump Gasket		
Application	Part No.	Retail
3.9L 4BT 1983-97 - O-Ring	C15065	\$2.06

Rear Main Seal		
Application	Part No.	Retail
3.9L 4BT	C15062	\$90.47

Pushrod Cover Gasket		
Application	Part No.	Retail
3.9L 4BT 1983-97	C15064	\$17.88

Fuel Pump Gaskets		
Application	Part No.	Retail
Fuel Pump Gasket	C5389-032	\$2.05
Injection Pump Gasket	C15061	\$4.48

Gasket Kits



To purchase a complete gasket kit order both top end and bottom end gasket kit

TOP END GASKET KIT

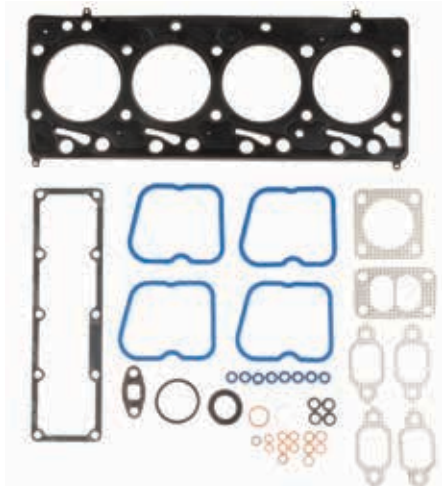

Application	Part No.	Retail
3.9L 4BT 4cyl Diesel 4.100" Bore	PRO3000T	\$246.02

BOTTOM END GASKET KIT



Application	Part No.	Retail
3.9L 4BT 4cyl Diesel	PRO3000B	\$246.02

5.9L 12v 6BT Inline 6 Diesel 1992-98

Head Gasket

MLX Head Gasket				
Bore	Thickness	Pkg Qty	Part No.	Retail
4.100"	.061"	1	C5955-061	\$256.03

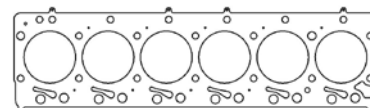

Additional thicknesses available see pages 2 - 4

Individual Gaskets

Valve Cover Gasket Set		
Application	Part No.	Retail
5.9L 6BT 1992-98	C15066	\$45.45

Intake Manifold Gasket Set		
Application	Part No.	Retail
5.9L 6BT 1992-98	C15067	\$50.76

Thermostat Housing Seal		
Application	Part No.	Retail
5.9L 6BT 1992-98	C15059	\$9.03

Oil Pan Gasket		
Application	Part No.	Retail
5.9L 6BT 1992-98	C15068	\$43.45

See page 55 for additional gaskets

CUMMINS

5.9L 12v 6BT Inline 6 Diesel 1992-98 (continued)

Individual Gaskets (continued)

Exhaust Manifold Gaskets Set		
Application	Part No.	Retail
5.9L 6BT 1992-98 - .040" MLS	C5725-040	\$57.04

Valve Stem Seal		
Application	Part No.	Retail
8x12.3x12x17 SN - Need 12	3164V	\$2.20

Timing Cover Seal		
Application	Part No.	Retail
5.9L 6BT 1992-98	C15063	\$91.29

Water Pump Gasket		
Application	Part No.	Retail
3.9L 4BT 1983-98 - O-Ring	C15065	\$2.06

Rear Main Seal		
Application	Part No.	Retail
5.9L 6BT 1992-98	C15062	\$90.47

Pushrod Cover Gasket		
Application	Part No.	Retail
5.9L 6BT 1989-99	C15069	\$23.31

Fuel Pump Gaskets		
Application	Part No.	Retail
Fuel Pump Gasket	C5389-032	\$2.05
Injection Pump Gasket	C15061	\$4.48

Gasket Kits



To purchase a complete gasket kit order both top end and bottom end gasket kit

TOP END GASKET KIT

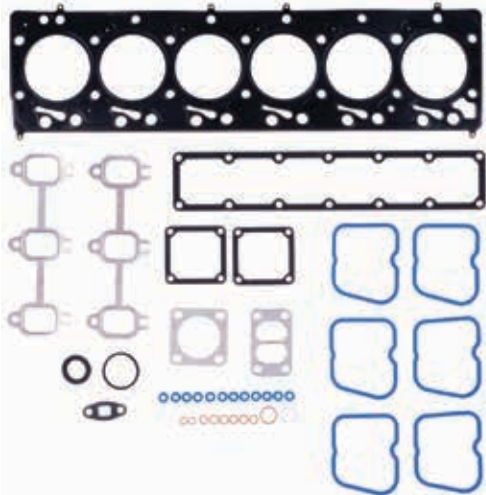

Application	Part No.	Retail
5.9L 6BT I6 Diesel 92-98 4.100" Bore	PRO3001T	\$432.74

BOTTOM END GASKET KIT



Application	Part No.	Retail
5.9L 6BT I6 Diesel 92-98	PRO3001B	\$279.41

5.9L 24v ISB Inline 6 Diesel 1998.5-02

Head Gaskets

MLX Head Gaskets				
Bore	Thickness	Pkg Qty	Part No.	Retail
4.100"	.061"	1	C5855-061	\$256.03

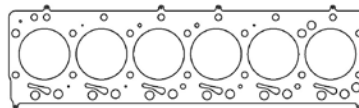

Additional thicknesses available see pages 2 - 4

Individual Gaskets

Valve Cover Gasket Set		
Application	Part No.	Retail
5.9L ISB 1998.5-02	C5614	\$174.83

Oil Pan Gasket		
Application	Part No.	Retail
5.9L 6BT 1998.5-02	C15068	\$43.45

Intake Manifold Gasket Set		
Application	Part No.	Retail
5.9L ISB 1998.5-02	C15067	\$50.76

Rear Main Seal		
Application	Part No.	Retail
5.9L 6BT 1998.5-02	C15062	\$90.47

See page 56 for additional gaskets



CUMMINS

5.9L 24v ISB Inline 6 Diesel 1998.5-02 (continued)

Individual Gaskets (continued)

Exhaust Manifold Gaskets Set		
Application	Part No.	Retail
5.9L ISB 1998.5-02	C5726-040	\$57.04

Pushrod Cover Gasket		
Application	Part No.	Retail
5.9L 6BT 1998.5-02	C15069	\$23.31

Water Pump Gasket		
Application	Part No.	Retail
3.9L 4BT 1998.5-02	C15065	\$2.06

Valve Stem Seals		
Application	Part No.	Retail
Intake VSS - Yellow (Need 12)	3214V	\$2.60
Exhaust VSS-Green (Need 12)	3215V	\$3.40

Timing Cover Seal		
Application	Part No.	Retail
5.9L 6BT 1998.5-02	C15063	\$91.29

Gasket Kit



To purchase a complete gasket kit order both top end and bottom end gasket kit

TOP END GASKET KIT

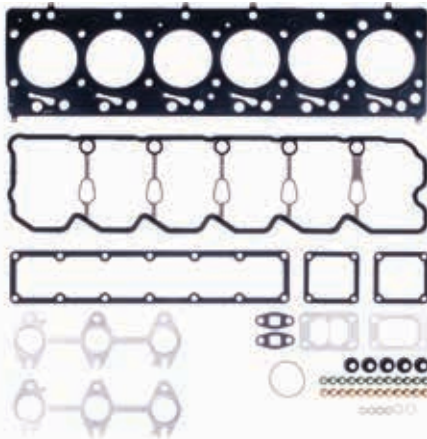

Application	Part No.	Retail
5.9L 24v ISB 6cyl 1998.5-02	PRO3002T	\$469.84

BOTTOM END GASKET KIT

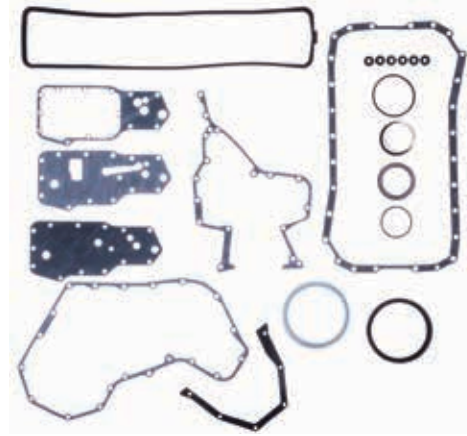

Application	Part No.	Retail
5.9L 24v ISB 6cyl 1998.5-02	PRO3002B	\$222.00

5.9L 24v ISB Common Rail Inline 6 Diesel 2003-07

Head Gaskets

MLX Head Gaskets				
Bore	Thickness	Pkg Qty	Part No.	Retail
4.100"	.061"	1	C5597-061	\$256.03

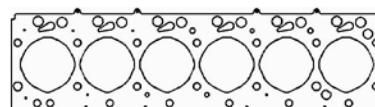

Additional thicknesses available see pages 2 - 4

Individual Gaskets

Fuel Injector Seal Kit		
Application	Part No.	Retail
5.9L Common Rail 2003-07	C15072	\$45.45

Valve Cover Gasket Set		
Application	Part No.	Retail
5.9L Common Rail 2003-07	C15070	87.41

Oil Pan Gasket Kit		
Application	Part No.	Retail
AFM Material (Includes Pump Pick Up)	C15470	\$50.44

Intake Manifold Gasket Set		
Application	Part No.	Retail
5.9L Common Rail 2003-07	C15067	\$50.76

See page 57 for additional gaskets

CUMMINS

5.9L 24v ISB Common Rail Inline 6 Diesel 2003-07 (continued)

Individual Gaskets (continued)

Pushrod Cover Gasket		
Application	Part No.	Retail
5.9L Common Rail 2003-07	C15071	\$33.00

Thermostat Seal		
Application	Part No.	Retail
5.9L Common Rail 2003-07	C15073	\$8.61

Exhaust Manifold Gaskets Set		
Application	Part No.	Retail
5.9L Common Rail 2003-07	C5726-040	\$57.04

Valve Stem Seals		
Application	Part No.	Retail
Intake VSS - Yellow (Need 12)	3218V	\$2.13
Exhaust VSS-Green (Need 12)	3219V	\$2.13

Gasket Kit



To purchase a complete gasket kit order both top end and bottom end gasket kit

TOP END GASKET KIT

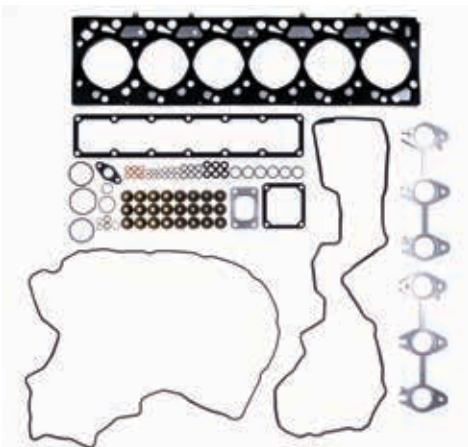

Application	Part No.	Retail
5.9L 24v Common Rail 03-07	PRO3003T	\$502.00

BOTTOM END GASKET KIT

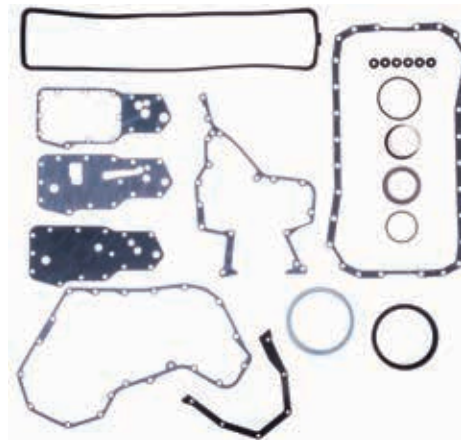

Application	Part No.	Retail
5.9L 24v Common Rail 03-07	PRO3002B	\$222.00

6.7L 24v ISB Inline 6 Diesel 2007.5+Up

Head Gaskets

MLX Head Gaskets 2007.5-18				
Bore	Thickness	Pkg Qty	Part No.	Retail
4.312"	.052"	1	C5609-052	\$256.03
4.312"	.056"	1	C5609-056	\$256.03
4.312"	.089"	1	C5609-089	\$295.14

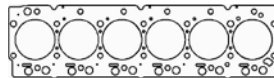

Additional thicknesses available
see pages 2 - 4

MLX Head Gasket 2019+				
Bore	Thickness	Pkg Qty	Part No.	Retail
4.327"	.054"	1	C15266-054	\$256.03

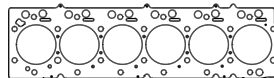

Individual Gaskets

Valve Stem Seal		
Application	Part No.	Retail
VSS - Yellow (Need 24)	3218V	\$2.13

Intake Gasket Set		
Application	Part No.	Retail
6.7L 24v ISB 2007.5+	C15076	\$51.54

Exhaust Manifold Gaskets Set		
Application	Part No.	Retail
6.7L 24v ISB 2007.5+Up (MLS)	C5726-040	\$57.04

Rear Main Seal		
Application	Part No.	Retail
6.7L 24v ISB 2007.5+Up	C15062	\$90.47

Timing Cover Seal		
Application	Part No.	Retail
6.7L 24v ISB 2007.5+Up	C15063	\$91.29

Water Pump Gasket		
Application	Part No.	Retail
6.7L 24v ISB 2007.5+Up	C15065	\$2.06

See page 58 for additional gaskets



CUMMINS

6.7L 24v ISB Inline 6 Diesel 2007.5+Up (continued)

Individual Gaskets (continued)

Thermostat Seal		
Application	Part No.	Retail
6.7L 24v ISB 2007.5+Up	C15073	\$8.61

Oil Cooler Gasket Set		
Application	Part No.	Retail
6.7L 24v ISB 2007.5+Up	C15075	\$51.47

Oil Pan Gasket		
Application	Part No.	Retail
6.7L 24v ISB 2007.5+Up	C15074	\$66.57

Pushrod Cover Gasket		
Application	Part No.	Retail
6.7L 24v ISB 2007.5+Up	C15071	\$33.00

Gasket Kits



To purchase a complete gasket kit order both top end and bottom end gasket kit

TOP END GASKET KIT

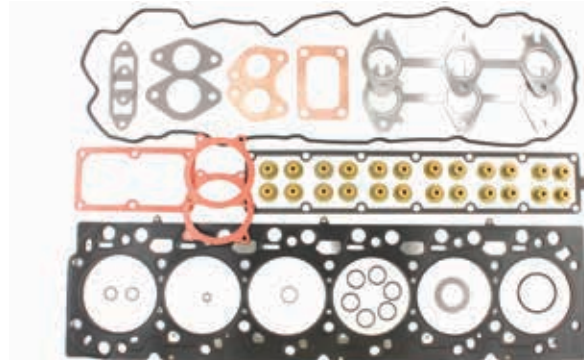

Application	Part No.	Retail
6.7L 24v ISB 6cyl 2007.5-18 4.312" Bore	PRO3004T	\$502.00

BOTTOM END GASKET KIT

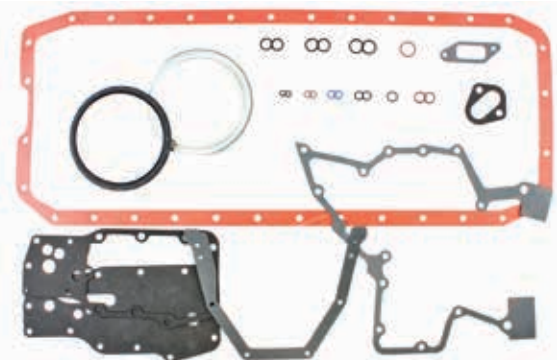

Application	Part No.	Retail
6.7L 24v ISB 6cyl 2007.5-18	PRO3004B	\$241.07

FORD

1.0L 2014-Up Fox EcoBoost

Head Gaskets

MLX Head Gaskets				
Bore	Thickness	Pkg Qty	Part No.	Retail
73mm	.032"	1	C14140-032	\$110.88

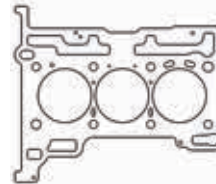

Additional thicknesses available see pages 2 - 4

1.6L 2013-19 EcoBoost

Head Gaskets

MLS Head Gaskets				
Bore	Thickness	Pkg Qty	Part No.	Retail
80.5mm	.024"	1	C15675-024	\$156.31

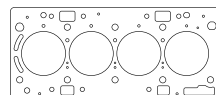

Additional thicknesses available see pages 2 - 4

1.6L Duratec Ti-VCT 2011-16

Head Gaskets

MLS Head Gaskets				
Bore	Thickness	Pkg Qty	Part No.	Retail
82mm	.028"	1	C4963-028	\$132.81



Additional thicknesses available see pages 2 - 4

FORD

1.6L & 1.8L CVH 4cyl 1985-93

Head Gaskets

MLS Head Gaskets

Bore	Thickness	Pkg Qty	Part No.	Retail
83mm	.051"	1	C5756-051	\$112.63

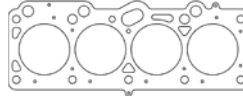

Additional thicknesses available
see pages 2 - 4

1.9L CVH 4cyl 1985-96

Head Gaskets

MLS Head Gaskets

Bore	Thickness	Pkg Qty	Part No.	Retail
82mm	.051"	1	C5136-051	\$112.63

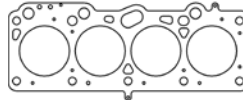

Additional thicknesses available
see pages 2 - 4

2.0L SOHC/DOHC NEP/YB Group A

Head Gaskets

MLS Head Gaskets

Bore	Thickness	Pkg Qty	Part No.	Retail
92.5mm	.040"	1	C4350-040	\$107.24

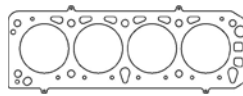

Additional thicknesses available
see pages 2 - 4

Individual Gaskets

Intake Gasket Set

Application	Part No.	Retail
Cosworth YB	C4502	\$50.03

Exhaust Manifold Gasket Set

Application	Part No.	Retail
Cosworth YB	C4334	\$20.09

Valve Cover Gaskets

Application	Part No.	Retail
Early YB Engine - .060" AFM	C4635	\$33.83
Late YB Engine - .060" AFM	C4636	\$33.83

Oil Pan Gasket

Application	Part No.	Retail
Cosworth YB Rails only	C4640	\$18.86

Front Cover Gasket

Application	Part No.	Retail
Cosworth YB	C4641	\$11.22

Cooling/Water Pump Gasket

Application	Part No.	Retail
Water Pump Gasket	C4637	\$6.39
Water Outlet Gasket	C4638	\$2.85
Thermostat Gasket	C4639	\$2.67

2.0L ZETEC DOHC 4cyl 1995-04

Head Gasket

MLS Head Gasket

Bore	Thickness	Pkg Qty	Part No.	Retail
87mm	.027"	1	C4279-027	\$102.61

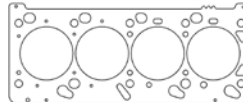

Additional thicknesses available
see pages 2 - 4

Individual Gaskets

Valve Cover Gaskets

Application	Part No.	Retail
2.0L Zetec DOHC 1995-97	C4643	\$34.31
2.0L Zetec DOHC 1998-04	C4644	\$64.10

Exhaust Manifold Gasket Set

Application	Part No.	Retail
2.0L Zetec 1994-04	C4645	\$21.15

Intake Gasket Sets

Application	Part No.	Retail
2.0L Zetec 1998-04	C4646	\$34.39
2.0L Zetec 1995-97	C4647	\$54.77

Valve Stem Seals

Application	Part No.	Retail
2.0L Zetec 1995-97 (16pk)	3181V-16	\$54.01
2.0L Zetec 1998-04 (16pk)	3182V-16	\$58.17

Oil Pan Gasket

Application	Part No.	Retail
2.0L Zetec 1995-04	C4649	\$31.99

Thermostat Gaskets

Application	Part No.	Retail
2.0L Zetec 1995-04 - Seal	C4651	\$2.24
2.0L Zetec 1995-04 - Housing	C4652	\$5.72

See page 60 for additional gaskets

FORD

2.0L Zetec DOHC 4cyl 1995-04 (continued)

Individual Gaskets (continued)

Cam Seal		
Application	Part No.	Retail
2.0L Zetec 1994-04	C4648	\$16.13

Rear Main Seal Set		
Application	Part No.	Retail
2.0L Zetec 1995-04	C4650	\$19.91

Gasket Kits



To purchase a complete gasket kit order both top end and bottom end gasket kit

TOP END GASKET KITS

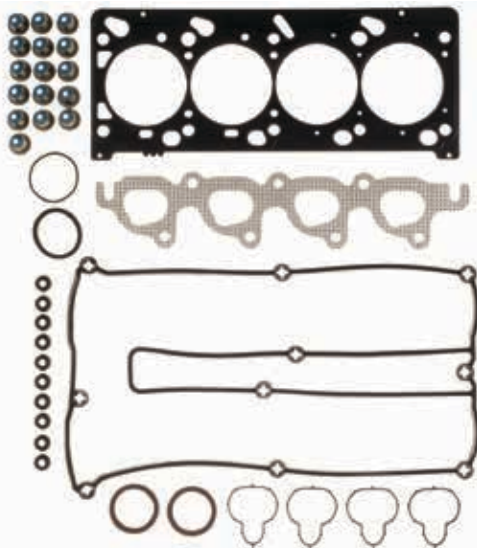

Application	Part No.	Retail
2.0L Zetec DOHC 1995-97 87mm Bore	PRO2029T	\$286.00
2.0L Zetec DOHC 1998-04 87mm Bore	PRO2030T	\$286.00

BOTTOM END GASKET KITS



Application	Part No.	Retail
2.0L Zetec DOHC 1995-97	PRO2029B	\$132.37
2.0L Zetec DOHC 1998-04	PRO2030B	\$132.37

2.3L "2300" SOHC 1974-97 4cyl

Head Gaskets

MLS Head Gaskets				
Bore	Thickness	Pkg Qty	Part No.	Retail
3.830"	.040"	1	C5369-040	\$84.41
3.940"	.040"	1	C5709-040	\$84.41

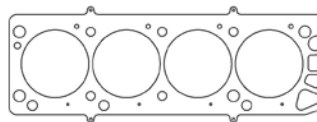

Additional thicknesses available
see pages 2 - 4

Individual Gaskets

Valve Cover Gaskets		
Application	Part No.	Retail
2300 2.3L 1974-93	C4653	\$44.29

Exhaust Manifold Gasket Set		
Application	Part No.	Retail
2300 2.3L 1974-93	C5372-064	\$18.28

Intake Gasket Set		
Application	Part No.	Retail
2300 2.3L	C5371-060	\$15.50

Valve Stem Seals		
Application	Part No.	Retail
2300 2.3L 1974-93 (need 8)	3168V	\$2.95

Oil Pan Gaskets		
Application	Part No.	Retail
2300 2.3L 1974-2/19/86	C5373	\$20.60
2300 2.3L 2/20/86-1990	C4669	\$57.11
2300 2.3L 1991-92	C4741	\$25.34
2300 2.3L 1993	C4778	\$25.34

Rear Main Seal Sets		
Application	Part No.	Retail
2300 2.3L 1974-81 2pc	C5688	\$34.21
2300 2.3L 1982-93 1pc	C5189	\$21.55

Water Pump Gasket		
Application	Part No.	Retail
2300 2.3L 1974-93	C4654	\$2.82

See page 61 for StreetPro gasket kits

2.3L "2300" SOHC 1974-97 4cyl (continued)

Gasket Kits



To purchase a complete gasket kit order both top end and bottom end gasket kit

TOP END GASKET KIT

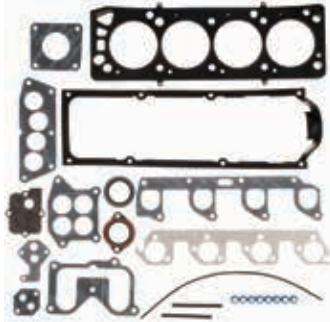

BOTTOM END GASKET KIT

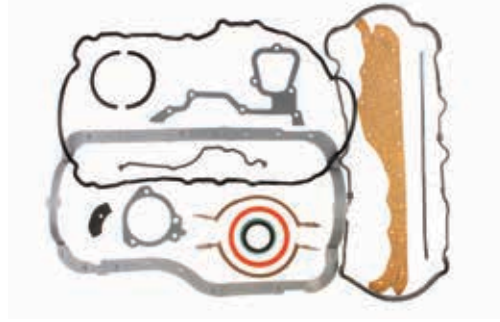

Application	Part No.	Retail
2300 2.3L 1974-97 3.830" Bore	PRO2031T	\$238.32

Application	Part No.	Retail
2300 2.3L 1974-97	PRO2031B	\$258.18

2.0L 2012-15 EcoBoost DOHC: 2013-2015 Ford Focus ST, 2012-2015 Ford Explorer

Head Gaskets

MLS Head Gaskets

Bore	Thickness	Pkg Qty	Part No.	Retail
89mm	.034"	1	C15317-034	\$112.63
89mm	.040"	1	C15317-040	\$112.63



Additional thicknesses available
see pages 2 - 4

2.3L EcoBoost DOHC: 2015-18 Mustang, 2016-19 Explorer, 2015-19 Lincoln MKC

Head Gaskets

MLS Head Gaskets

Bore	Thickness	Pkg Qty	Part No.	Retail
89.25mm	.040"	1	C15279-040	\$132.81

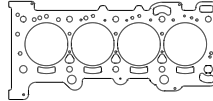

Additional thicknesses available
see pages 2 - 4

Individual Gaskets

Valve Cover Gasket

Application	Part No.	Retail
Valve Cover Gasket	C15445	\$42.55

2.3L EcoBoost DOHC: 2016-2018 Ford Focus RS, 2020-2023 Ford Mustang

Head Gaskets

MLX Head Gaskets

Bore	Thickness	Pkg Qty	Part No.	Retail
89mm	.040"	1	C15294-040	\$132.81

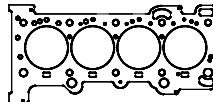

Additional thicknesses available
see pages 2 - 4

Individual Gaskets

Valve Cover Gasket

Application	Part No.	Retail
Valve Cover Gasket	C15445	\$42.55

2.0L 2005-13 & 4.3L 2001-11 Duratec DOHC: 2003-2011 Focus, 2001-2011 Ranger

Head Gaskets

MLS Head Gaskets

Bore	Thickness	Pkg Qty	Part No.	Retail
89.5mm	.018"	1	C5843-018	\$112.63
92mm	.018"	1	C5842-018	\$112.63

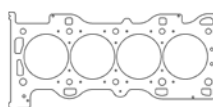

Additional thicknesses available
see pages 2 - 4

See page 62 for additional gaskets



FORD

2.0L 2005-13 & 4.3L 2001-11 Duratec DOHC: 2003-2011 Focus, 2001-2011 Ranger (continued)

Individual Gaskets

Intake Gasket Set

Application	Part No.	Retail
2.3L Duratec 2003-08	C4842-060	\$21.00

Exhaust Manifold Gaskets

Application	Part No.	Retail
2.3L Duratec (w/ extra port)	C4840-064	\$28.14
2.3L Duratec (w/o extra port)	C4841-064	\$28.14

2.3L 2006-2009 Duratec: 2006-2009 Fusion

Head Gaskets

MLS Head Gasket

Bore	Thickness	Pkg Qty	Part No.	Retail
90mm	.040"	1	C5906-040	\$112.63

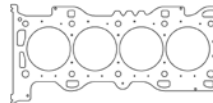

Additional thicknesses available
see pages 2 - 4

2.7L EcoBoost

Head Gaskets

MLX Head Gaskets - Right Side

Bore	Thickness	Pkg Qty	Part No.	Retail
85.6mm	.036"	1	C15447-036	\$97.46



Additional thicknesses available
see pages 2 - 4

MLX Head Gaskets - Left Side

Bore	Thickness	Pkg Qty	Part No.	Retail
85.6mm	.036"	1	C15448-036	\$97.46

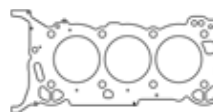

2.9L V6 1986-1992

Head Gaskets

MLX Head Gaskets - Left Side

Bore	Thickness	Pkg Qty	Part No.	Retail
95.5mm	.050"	1	C15679-050	\$102.61

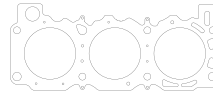

Additional thicknesses available
see pages 2 - 4

MLS Head Gaskets - Right Side

Bore	Thickness	Pkg Qty	Part No.	Retail
95.5mm	.050"	1	C15678-050	\$102.61



3.5L Cyclone Duratec V6 2010-Present

Head Gaskets

MLX Head Gaskets - Right Side

Bore	Thickness	Pkg Qty	Part No.	Retail
95mm	.048"	1	C15404-048	\$137.84

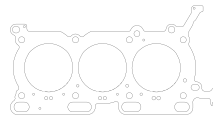

Additional thicknesses available
see pages 2 - 4

MLX Head Gaskets - Left Side

Bore	Thickness	Pkg Qty	Part No.	Retail
95mm	.048"	1	C15405-048	\$137.84



3.5L Cyclone EcoBoost V6 First Gen 2011-2016

Head Gaskets

MLS Head Gaskets - Right Side

Bore	Thickness	Pkg Qty	Part No.	Retail
95mm	.047"	1	C15554-047	\$112.35

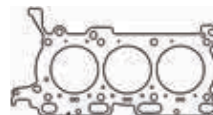

Additional thicknesses available
see pages 2 - 4

MLS Head Gaskets - Left Side

Bore	Thickness	Pkg Qty	Part No.	Retail
95mm	.047"	1	C15555-047	\$112.35

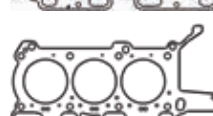

FORD

3.5L Cyclone EcoBoost V6 (D35 Second Gen) 2017+ 150 SVT Raptor, Lincoln Navigator

Head Gaskets

MLS Head Gaskets - Right Side

Bore	Thickness	Pkg Qty	Part No.	Retail
95mm	.040"	1	C15463-040	\$112.35
97.5mm	.040"	1	C15473-040	\$112.35

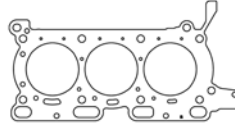

Additional thicknesses available
see pages 2 - 4

MLS Head Gaskets - Left Side

Bore	Thickness	Pkg Qty	Part No.	Retail
95mm	.040"	1	C15464-040	\$112.35
97.5mm	.040"	1	C15474-040	\$112.35

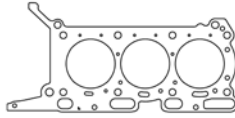

3.9L AJ30/AJ35 DOHC V8 2000-06

Head Gasket

MLS Head Gaskets - Right Side

Bore	Thickness	Pkg Qty	Part No.	Retail
87mm	.030"	1	C5770-030	\$115.44
93mm	.030"	1	C5771-030	\$115.44

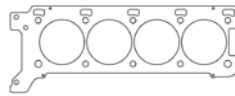

Additional thicknesses available
see pages 2 - 4

MLS Head Gaskets - Left Side

Bore	Thickness	Pkg Qty	Part No.	Retail
87mm	.030"	1	C5772-030	\$115.44
93mm	.030"	1	C5773-030	\$115.44

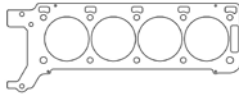

4.0L V6 1997-2010

Head Gaskets

MLX Head Gaskets - Left Side

Bore	Thickness	Pkg Qty	Part No.	Retail
103mm	.040"	1	C15382-040	\$110.88

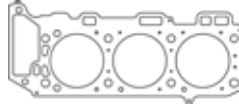

Additional thicknesses available
see pages 2 - 4

MLX Head Gaskets - Right Side

Bore	Thickness	Pkg Qty	Part No.	Retail
103mm	.040"	1	C15381-040	\$110.88

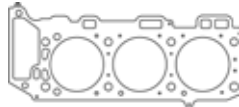

4.6L & 5.4L SOHC/DOHC Modular V8

Head Gaskets

MLS Head Gaskets - Left Side

Bore	Thickness	Pkg Qty	Part No.	Retail
92mm	.030"	1	C5118-030	\$147.49
94mm	.030"	1	C5502-030	\$147.49

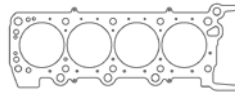

Additional thicknesses available
see pages 2 - 4

MLS Head Gaskets - Right Side

Bore	Thickness	Pkg Qty	Part No.	Retail
92mm	.030"	1	C5119-030	\$147.49
94mm	.030"	1	C5503-030	\$147.49

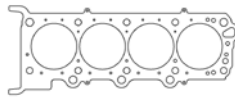

MLX Head Gaskets - Left Side

Bore	Thickness	Pkg Qty	Part No.	Retail
92mm	.032"	1	C15259-032	\$181.93
94mm	.032"	1	C15261-032	\$181.93

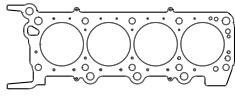

MLX Head Gaskets - Right Side

Bore	Thickness	Pkg Qty	Part No.	Retail
92mm	.032"	1	C15258-032	\$181.93
94mm	.032"	1	C15260-032	\$181.93

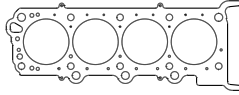

See page 64 for additional gaskets

FORD

4.6L & 5.4L SOHC/DOHC Modular V8 (continued)

Individual Gaskets

Valve Cover Gasket Sets

Application	Part No.	Retail
4.6L DOHC 1996-98	C5177	\$137.53
4.6L SOHC 1996-04	C5178	\$54.92
4.6L SOHC 2002-04 Truck	C5179	\$54.92

Intake Gaskets

Application	Part No.	Retail
4.6L DOHC 1998	C5180	\$33.66
4.6L DOHC 1996-97	C5181	\$51.45
4.6L DOHC 1996-98 - Cover	C5182	\$60.60
4.6L DOHC 1996-98 - Plenum	C5183	\$64.93
4.6L SOHC 1995-00	C5184	\$40.24
4.6L SOHC 2000-04 Truck	C5185	\$117.55
4.6L SOHC 00-04 Truck Plenum	C5186	\$37.18
4.6L SOHC 97-99 Truck Plenum	C5187	\$34.26

Exhaust Gaskets

Application	Part No.	Retail
4.6/5.4L SOHC 1991-01	C5853-030	\$41.48
4.6L DOHC 1993-99	C5012-030	\$45.63
5.4/5.8L Shelby GT500 2007-14	C5805-030	\$52.34

Throttle Body Gaskets

Application	Part No.	Retail
SOHC 1996-01 Spacer-TB	C15078	\$3.91
DOHC 1996-98 .020" Fiber	C15079	\$5.85
SOHC 1996-00 Spacer-Manifold	C15080	\$14.06
4.6L SOHC 1999-11 - Rubber	C15081	\$8.60

Oil Pan Gasket

Application	Part No.	Retail
4.6/5.4L 1996-04	C5188	\$44.35

Rear Main Seal

Application	Part No.	Retail
4.6/5.4L 1996-04 - 1pc	C5189	\$21.55

Front Crank Seals

Application	Part No.	Retail
4.6/5.4L SOHC/DOHC 1996-99	C5192	\$23.23
4.6/5.4L SOHC 2000-04	C5191	\$16.51

Water Pump O-Ring

Application	Part No.	Retail
4.6/5.4L SOHC/DOHC 1992-09	C5190	\$5.68

Gasket Kits



To purchase a complete gasket kit order both top end and bottom end gasket kit

TOP END GASKET KITS

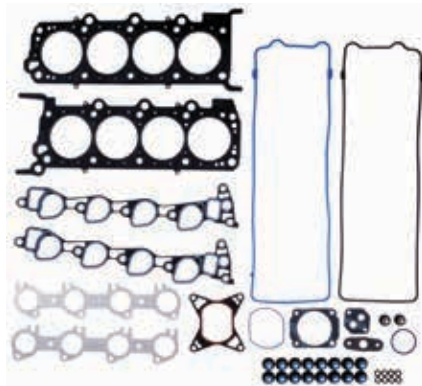

Application	Part No.	Retail
4.6L DOHC 1996-98 92mm Bore	PRO1017T	\$499.38
4.6L SOHC 1996-98 92mm Bore	PRO1018T	\$319.60
4.6L SOHC 1999-04 92mm Bore	PRO1019T	\$282.03
4.6L SOHC 1997-04 Truck 92mm Bore	PRO1020T	\$319.60

BOTTOM END GASKET KITS

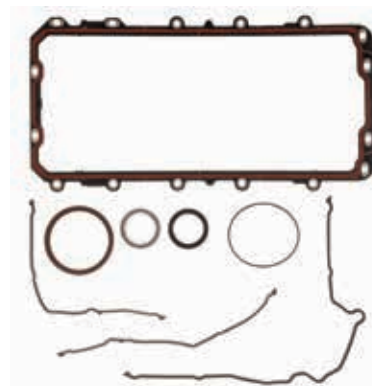

Application	Part No.	Retail
4.6L DOHC 1996-98	PRO1017B	\$121.80
4.6L SOHC 1996-98	PRO1018B	\$117.72
4.6L SOHC 1999-04	PRO1019B	\$120.23
4.6L SOHC 1997-04 Truck	PRO1020B	\$193.28

4.6L SOHC 3v Heads Modular 2005-10

Head Gaskets

MLS Head Gaskets - Left Side

Bore	Thickness	Pkg Qty	Part No.	Retail
94mm	.030"	1	C5969-030	\$147.49
94mm	.040"	1	C5969-040	\$147.49

MLS Head Gaskets - Right Side

Bore	Thickness	Pkg Qty	Part No.	Retail
94mm	.030"	1	C5970-030	\$147.49
94mm	.040"	1	C5970-040	\$147.49

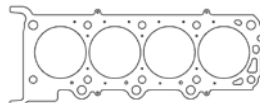
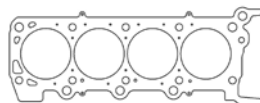

Additional thicknesses available
see pages 2 - 4

See page 65 for additional gaskets

FORD

4.6L SOHC 3v Heads Modular 2005-10 (continued)

Head Gaskets (continued)

MLX Head Gaskets - Left Side

Bore	Thickness	Pkg Qty	Part No.	Retail
94mm	.032"	1	C15556-032	\$147.49
94mm	.040"	1	C15556-040	\$181.93
94mm	.052"	1	C15556-054	\$191.03

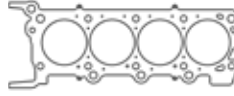

Additional thicknesses available
see pages 2 - 4

MLX Head Gaskets - Right Side

Bore	Thickness	Pkg Qty	Part No.	Retail
94mm	.032"	1	C15557-032	\$147.49
94mm	.040"	1	C15557-040	\$181.93
94mm	.052"	1	C15557-054	\$191.03

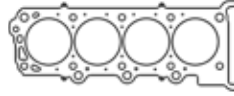

Individual Gaskets

Exhaust Gaskets

Application	Part No.	Retail
4.6/5.4L 3V Heads - MLS D-Port	C5997-030	\$44.75
4.6/5.4L 3V Heads - MLS	C5852-030	\$44.75

5.4L SOHC 3v Heads Modular 2004-14

Head Gaskets

MLS Head Gaskets - Left Side

Bore	Thickness	Pkg Qty	Part No.	Retail
94mm	.030"	1	C5971-030	\$147.49

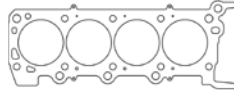

Additional thicknesses available
see pages 2 - 4

MLS Head Gaskets - Right Side

Bore	Thickness	Pkg Qty	Part No.	Retail
94mm	.030"	1	C5972-030	\$147.49

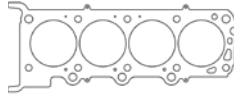

Individual Gaskets

Exhaust Gaskets

Application	Part No.	Retail
4.6/5.4L 3V Heads - MLS D-Port	C5997-030	\$44.75
4.6/5.4L 3V Heads - MLS	C5852-030	\$44.75

5.0L Gen-1 "Coyote" DOHC Modular V8 2011-2014

Head Gaskets

MLS Head Gaskets - Left Side

Bore	Thickness	Pkg Qty	Part No.	Retail
94mm	.040"	1	C5287-040	\$147.49
94mm	.045"	1	C5287-045	\$154.86
94mm	.056"	1	C5287-056	\$191.03

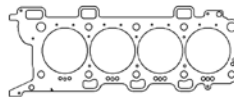

Additional thicknesses available
see pages 2 - 4

MLS Head Gaskets - Right Side

Bore	Thickness	Pkg Qty	Part No.	Retail
94mm	.040"	1	C5286-040	\$147.49
94mm	.045"	1	C5286-045	\$154.86
94mm	.056"	1	C5286-056	\$191.03

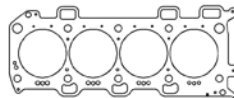

MLX Head Gaskets - Left Side

Bore	Thickness	Pkg Qty	Part No.	Retail
94mm	.040"	1	C15368-040	\$181.93

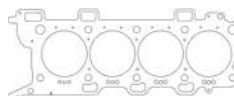

MLX Head Gaskets - Right Side

Bore	Thickness	Pkg Qty	Part No.	Retail
94mm	.040"	1	C15367-040	\$181.93



See page 66 for additional gaskets



FORD

5.0L Gen-1 "Coyote" DOHC Modular V8 2011-2014 (continued)

Individual Gaskets

Exhaust Gaskets		
Application	Part No.	Retail
5.0L DOHC Coyote - HTS	C5392HTS	\$36.33
5.0L DOHC Coyote - MLS	C5392-030	\$58.32

Valve Stem Seals (32 Pack)		
Application	Part No.	Retail
Hat Style - Viton Steel Body - INT/EXH	3268V-32	\$45.45

Intake Manifold Gasket Set		
Application	Part No.	Retail
2011-2014 5.0L	C15444	\$34.10

Timing Cover Set		
Application	Part No.	Retail
Ford 5.0L Coyote 2011-2017	C15493	\$103.02

Valve Cover Set		
Application	Part No.	Retail
Ford 5.0L 2011-2014	C15576	\$120.39

Gasket Kits



To purchase a complete gasket kit order both top end and bottom end gasket kit

TOP END GASKET KIT

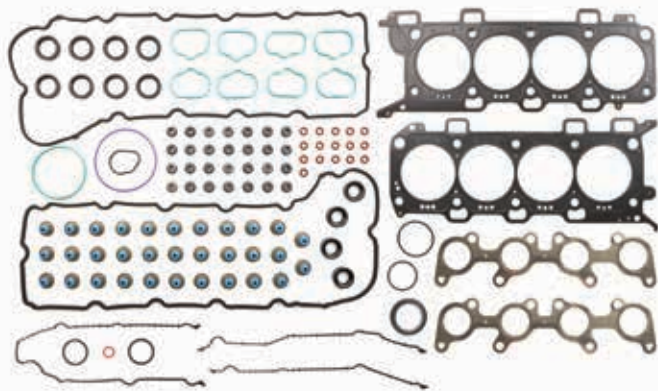

Application	Part No.	Retail
2011-14 Ford 5.0L Gen-1 Coyote Modular V8	PRO1049T	\$478.79

BOTTOM END GASKET KIT

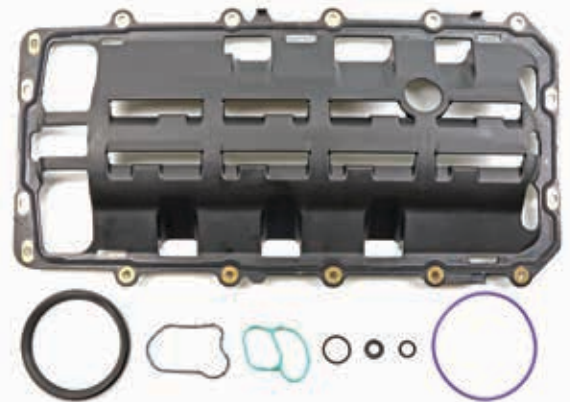

Application	Part No.	Retail
2011-17 Ford 5.0L Gen-1/2 Coyote Modular V8	PRO1049B	\$190.30

5.0L Gen-2 "Coyote" DOHC Modular V8 2015-2017

Head Gaskets

MLS Head Gaskets - Left Side				
Bore	Thickness	Pkg Qty	Part No.	Retail
94mm	.040"	1	C15370-040	\$147.49
94mm	.045"	1	C15370-045	\$154.86
94mm	.051"	1	C15370-051	\$154.86
94mm	.070"	1	C15370-070	\$191.03

MLS Head Gaskets - Right Side				
Bore	Thickness	Pkg Qty	Part No.	Retail
94mm	.040"	1	C15369-040	\$147.49
94mm	.045"	1	C15369-045	\$154.86
94mm	.051"	1	C15369-051	\$154.86
94mm	.070"	1	C15369-070	\$191.03

MLX Head Gaskets - Left Side				
Bore	Thickness	Pkg Qty	Part No.	Retail
94mm	.040"	1	C15366-040	\$181.93
94mm	.051"	1	C15366-051	\$191.03

MLX Head Gaskets - Right Side				
Bore	Thickness	Pkg Qty	Part No.	Retail
94mm	.040"	1	C15365-040	\$181.93
94mm	.051"	1	C15365-051	\$191.03

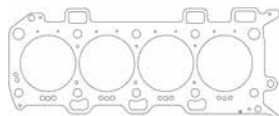
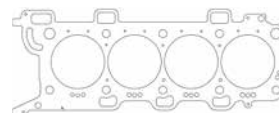
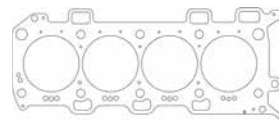
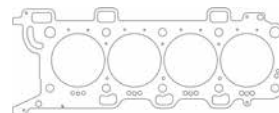

Additional thicknesses available see pages 2 - 4

See page 67 for additional gaskets

FORD

5.0L Gen-2 "Coyote" DOHC Modular V8 2015-2017 (continued)

Individual Gaskets

Exhaust Gaskets

Application	Part No.	Retail
5.0L DOHC Coyote - MLS	C5392-030	\$58.32

Intake Gaskets

Application	Part No.	Retail
Molded Rubber Intake Set of 8	C15465	\$41.96

Valve Cover Gasket Set

Application	Part No.	Retail
Ford 5.0L/5.2L 2014-2018	C15442	\$127.27

Valve Stem Seals (32 Pack)

Application	Part No.	Retail
Hat Style - Viton Steel Body - INT/EXH	3268V-32	\$45.45

Timing Cover Set

Application	Part No.	Retail
Ford 5.0L Coyote 2011-2017	C15493	\$103.02

Gasket Kits



To purchase a complete gasket kit order both top end and bottom end gasket kit

TOP END GASKET KIT

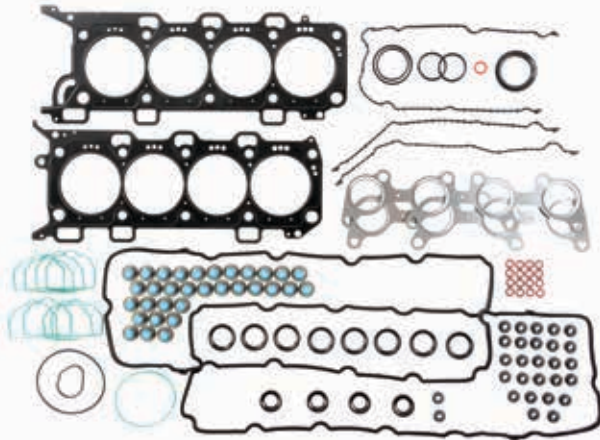

Application	Part No.	Retail
2015-17 Ford 5.0L Gen-2 Coyote Modular V8 94mm	PRO1052T	\$512.82

BOTTOM END GASKET KIT

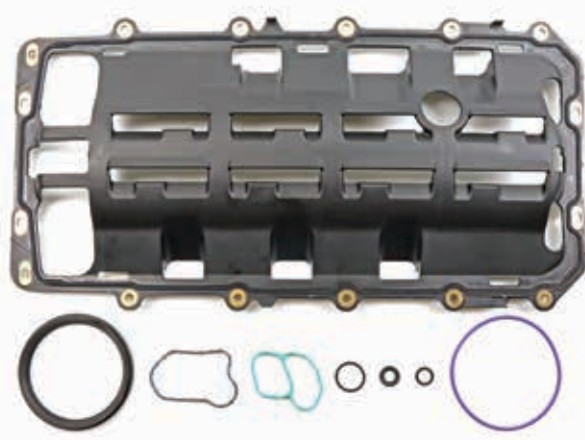

Application	Part No.	Retail
2011-17 Ford 5.0L Gen-1/2 Coyote Modular V8 94mm	PRO1049B	\$190.30

5.0L Gen-3 "Coyote" DOHC Modular V8 2018-2023

Head Gaskets

MLS Head Gaskets - Right Side

Bore	Thickness	Pkg Qty	Part No.	Retail
94.5mm	.030"	1	C15435-030	\$147.49

MLS Head Gaskets - Left Side

Bore	Thickness	Pkg Qty	Part No.	Retail
94.5mm	.030"	1	C15436-030	\$147.49

MLX Head Gaskets - Right Side

Bore	Thickness	Pkg Qty	Part No.	Retail
94.5mm	.040"	1	C15548-040	\$181.93

MLX Head Gaskets - Left Side

Bore	Thickness	Pkg Qty	Part No.	Retail
94.5mm	.040"	1	C15549-040	\$181.93

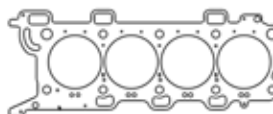
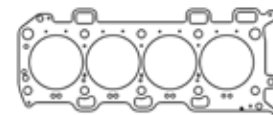
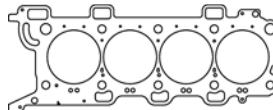
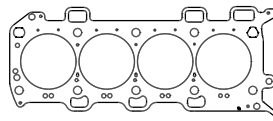

Additional thicknesses available see pages 2 - 4

See page 68 for additional gaskets



FORD

5.0L Gen-3 "Coyote" DOHC Modular V8 2018-2023 (continued)

Individual Gaskets

Exhaust Gaskets

Application	Part No.	Retail
5.0L DOHC Coyote - HTS	C5392HTS	\$36.33
5.0L DOHC Coyote - MLS	C5392-030	\$58.32

5.0L Gen-4 "Coyote" DOHC Modular V8 2024+

Head Gaskets

HP Head Gaskets - Right Side

Bore	Thickness	Pkg Qty	Part No.	Retail
94.5mm	.045"	1	C15697-045	\$164.24

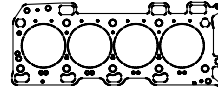

Additional thicknesses available
see pages 2 - 4

HP Head Gaskets - Left Side

Bore	Thickness	Pkg Qty	Part No.	Retail
94.5mm	.045"	1	C15698-045	\$164.24

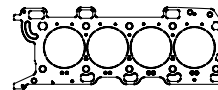

5.2L "Voodoo" DOHC Modular V8 2015-18

Head Gaskets

MLS Head Gaskets - Left Side

Bore	Thickness	Pkg Qty	Part No.	Retail
95mm	.036"	1	C15388-036	\$147.49
95mm	.040"	1	C15388-040	\$147.49

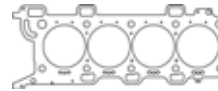

Additional thicknesses available
see pages 2 - 4

MLS Head Gaskets - Right Side

Bore	Thickness	Pkg Qty	Part No.	Retail
95mm	.036"	1	C15387-036	\$147.49
95mm	.040"	1	C15387-040	\$147.49

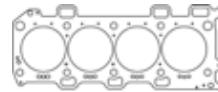

MLX Head Gasket s- Left Side

Bore	Thickness	Pkg Qty	Part No.	Retail
95mm	.044"	1	C15654-044	\$191.03

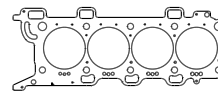

MLX Head Gaskets- Right Side

Bore	Thickness	Pkg Qty	Part No.	Retail
95mm	.044"	1	C15653-044	\$191.03

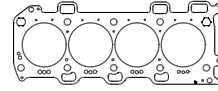

Individual Gaskets

Valve Cover Gasket Set

Application	Part No.	Retail
Ford 5.2L 2015-2018	C15442	\$127.27

Intake Gasket Set

Application	Part No.	Retail
Ford 5.2L 2015-18 Molded Rubber Intake Set of 8	C15444	\$34.10

Timing Cover Set

Application	Part No.	Retail
Ford 5.0L Coyote 2011-2017; 5.2L Voodoo 2015-2018	C15493	\$103.02

Exhaust Gasket

Application	Part No.	Retail
5.2L DOHC Voodoo - MLS 2015-2020	C15601-030	\$53.35

5.2L "Voodoo", "Predator" DOHC Modular V8 2020-2021

Head Gaskets

MLX Head Gasket - Left Side

Bore	Thickness	Pkg Qty	Part No.	Retail
95mm	.046"	1	C15663-046	\$191.03

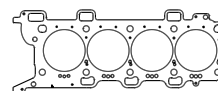

Additional thicknesses available
see pages 2 - 4

MLX Head Gasket - Right Side

Bore	Thickness	Pkg Qty	Part No.	Retail
95mm	.046"	1	C15662-046	\$191.03

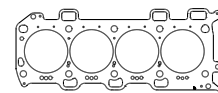

See page 69 for additional gaskets

FORD

5.2L "Voodoo", "Predator" DOHC Modular V8 2020-2021 (continued)

Individual Gaskets

Intake Gasket Set		
Application	Part No.	Retail
Ford 5.2L 2020-2021 Molded Rubber Intake Set of 8	C15444	\$34.10

Exhaust Gasket		
Application	Part No.	Retail
Ford 5.2L MLS Exhaust Manifold Gasket Set 2020-2021	C15601-030	\$53.35

5.8L "Trinity" DOHC Modular V8 2013-14

Head Gaskets

MLX Head Gaskets - Left Side				
Bore	Thickness	Pkg Qty	Part No.	Retail
95.25mm	.051"	1	C5017-051	\$191.03
95mm	.055"	1	C5017-055	\$191.03

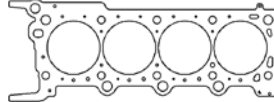

Additional thicknesses available
see pages 2 - 4

MLX Head Gaskets - Right Side				
Bore	Thickness	Pkg Qty	Part No.	Retail
95.25mm	.030"	1	C5018-051	\$191.03
95mm	.055"	1	C5018-055	\$191.03

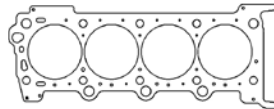

4.6/5.4L 2v/4v Modular V8 w/Darton Solid Sleeves

Head Gaskets

MLS Head Gaskets - Left Side				
Bore	Thickness	Pkg Qty	Part No.	Retail
95.25mm	.040"	1	C5856-040	\$147.49

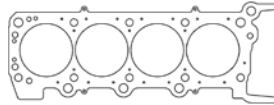

Additional thicknesses available
see pages 2 - 4

MLS Head Gaskets - Right Side				
Bore	Thickness	Pkg Qty	Part No.	Retail
95.25mm	.030"	1	C5857-040	\$147.49

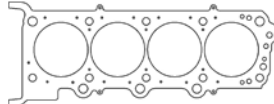

4.6/5.4L 2v/4v Modular V8 w/Darton M.I.D. Sleeves

Head Gaskets

MLS Head Gaskets - Left Side				
Bore	Thickness	Pkg Qty	Part No.	Retail
95.25mm	.040"	1	C5858-040	\$147.49

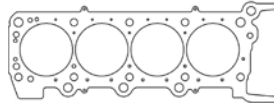

Additional thicknesses available
see pages 2 - 4

MLS Head Gaskets - Right Side				
Bore	Thickness	Pkg Qty	Part No.	Retail
95.25mm	.030"	1	C5859-040	\$147.49

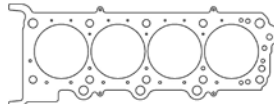

239, 256, 272, 292, 312 Y-Block V8 1956-64

Head Gaskets

MLS Head Gaskets - Right Side				
Bore	Thickness	Pkg Qty	Part No.	Retail
3.860"	.040"	1	C15170-040	\$115.44

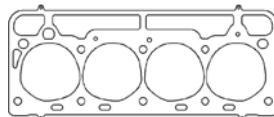

Additional thicknesses available
see pages 2 - 4

MLS Head Gaskets - Left Side				
Bore	Thickness	Pkg Qty	Part No.	Retail
3.860"	.040"	1	C15171-040	\$115.44

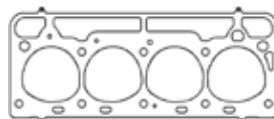

See page 70 for additional gaskets



FORD

239, 256, 272, 292, 312 Y-Block V8 1956-64 (continued)

Individual Gaskets

Exhaust Gasket Set		
Application	Part No.	Retail
Y-Block 1956-64	C15082-064	\$36.33

Oil Pan Gasket		
Application	Part No.	Retail
Y-Block 1956-64	C15084	\$44.10

Intake Gasket Set		
Application	Part No.	Retail
Y-Block 1956-64	C15083	\$39.97

Timing Cover Gasket		
Application	Part No.	Retail
Y-Block 1956-64	C15085	\$15.74

Valve Cover Gasket (sold individually)		
Application	Part No.	Retail
Y-Block 1956-64	C15086	\$29.52

Water Pump O-Ring		
Application	Part No.	Retail
Y-Block 1956-64	C15087	\$18.72

Gasket Kits



To purchase a complete gasket kit order both top end and bottom end gasket kit

TOP END GASKET KIT

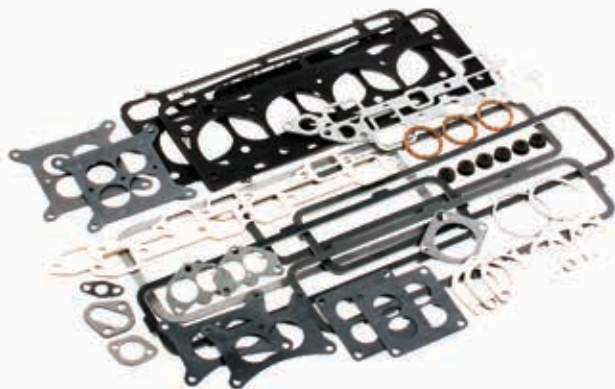

Application	Part No.	Retail
239-312 Y-Block 1956-64 3.860" Bore	PRO1039T	\$332.08

BOTTOM END GASKET KIT



Application	Part No.	Retail
239-312 Y-Block 1956-64	PRO1039B	\$168.29

Windsor Small Block V8 SVO & non-SVO 1962-00

Head Gaskets

MLS Head Gaskets - SVO Round Bore				
Bore	Thickness	Pkg Qty	Part No.	Retail
4.030"	.040"	1	C5478-040	\$97.72
4.060"	.040"	1	C5479-040	\$97.72
4.080"	.040"	1	C5480-040	\$97.72
4.100"	.040"	1	C5481-040	\$97.72
4.155"	.040"	1	C5483-040	\$97.72
4.195"	.051"	1	C5509-051	\$102.61
4.200"	.040"	1	C5485-040	\$97.72

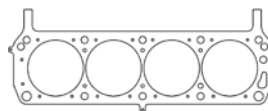

Additional thicknesses available
see pages 2 - 4

MLX Head Gaskets - SVO Round Bore				
Bore	Thickness	Pkg Qty	Part No.	Retail
4.100"	.040"	1	C15372-040	\$125.65
4.170"	.040"	1	C15639-040	\$125.65
4.200"	.040"	1	C5757-040	\$125.65

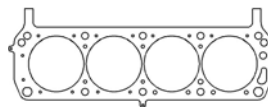

See page 71 for additional gaskets

Windsor Small Block V8 SVO & non-SVO 1962-00 (continued)

Head Gaskets (continued)

MLS Head Gaskets - non SVO Round Bore

Bore	Thickness	Pkg Qty	Part No.	Retail
4.030"	.027"	1	C5511-027	\$97.72
4.030"	.040"	1	C5511-040	\$97.72
4.060"	.040"	1	C5512-040	\$97.72
4.080"	.040"	1	C5513-040	\$97.72
4.100"	.040"	1	C5514-040	\$97.72
4.155"	.040"	1	C5515-040	\$97.72
4.155"	.051"	1	C5515-051	\$102.61
4.200"	.040"	1	C5517-040	\$97.72

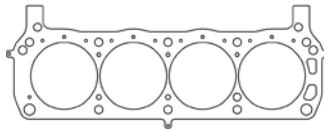

Additional thicknesses available
see pages 2 - 4

MLX Head Gaskets - non-SVO Round Bore

Bore	Thickness	Pkg Qty	Part No.	Retail
4.100"	.040"	1	C15371-040	\$125.65
4.170"	.040"	1	C15640-040	\$125.65
4.200"	.040"	1	C5025-040	\$125.65

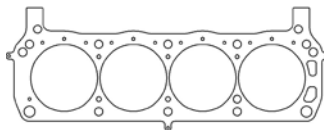

Individual Gaskets

Valve Cover Gasket (sold individually)

Application	Part No.	Retail
289/302/351-Molded Rubber	C5974	\$19.47
SVO, M6049 Heads .094" KF	C5659-094	\$23.15

Timing Cover Sets

Application	Part No.	Retail
260/289/302/351W 1962-78	C5064	\$28.58
302/351W 1979-97	C5065	\$28.58

Intake Manifold Gaskets

Application	Part No.	Retail
N351 1.279" x 2.115" Rectangle Port	C5652-060	\$30.94
M6049 Yates 3C 2.00" x 1.35"	C5268-047	\$30.01
End Rail Gaskets	C5653-060	\$5.15
Stock and Small Race Port Heads 1.200" x 2.000" .060" Fiber	C15648-060	\$22.69
TFS, GT-40, and N Heads 1.400" x 2.250" .060" Fiber	C15649-060	\$22.69

Oil Pan Gasket Sets

Application	Part No.	Retail
289/302 4pc Kit	C15091	\$38.01
351W 4pc Kit	C5279-094	\$42.87
351W 4pc Kit - For Stokers	C15092	\$38.01

Exhaust Manifold Gaskets

Application	Part No.	Retail
N351 1.585" x 1.681" .064" AM	C5655-064	\$28.14
351W 1.516" x 1.570" Rectangle Port MLS	C15176-030	\$47.05
289/302 1.120" x 1.480" MLS	C5898-030	\$47.05
289/302 1.127" x 1.750" MLS	C5899-030	\$47.05
Ford Racing N, Trick Flow Specialties R 1.668" x 1.617" MLS	C15683-030	\$24.71
Yates 1.725" x 1.890" .064" AM	C5357-064	\$40.86
Yates MLS Ind Ports (8 pcs)	C5665-040	\$44.19
Trick Flow R, N Heads 1.665" x 1.617" .060" HTS	C15650-060	\$31.43
Stock And Inline Spread Bolt Dart & TFS Heads 1.422" x 1.625" .060" HTS	C15651-060	\$35.84

Rear Main Seals

Application	Part No.	Retail
289/302 Viton 2pc 1968-82	C5688	\$34.21
351W SN 2pc 1969-83	C5689	\$36.26
289/302 1pc 1983-01	C5189	\$21.55
351W 1pc 1983-01	C15090	\$19.37
351W w/302 Crank	C5384	\$124.53

Water Pump Gaskets

Application	Part No.	Retail
289/302/351W 67-91 WP Gasket	C5662-060	\$10.29
302/351W 69-85 Cover Plate	C5353	\$11.22
289/302 63-65.5 Plate to Block	C15093	\$11.99
289/302/351W 63-69 Pump to Plate	C15094	\$11.99
351W 80-87 Water Pump Plate	C15095	\$9.88
302/351W 86-97 Pump to Plate	C15096	\$9.88
351W 88-95 Pump to Block	C15097	\$9.88
302 91-01 Plate to Block Gasket	C15098	\$9.88

Carb/Throttle Body Gaskets

Application	Part No.	Retail
Holley 4bbl Open Plenum Carb	C5263	\$6.57
5.0L 1986-93 TB Gasket	C15099	\$6.97
5.0/5.8L 85-97 Truck TB Gasket	C15100	\$3.91
3.8/5.0L 89-95 TB Gasket	C15101	\$3.91

Fuel Pump Gasket

Application	Part No.	Retail
Small Block Ford	C5389-060	\$2.05

See page 72 for StreetPro gasket kits

FORD

Windsor Small Block V8 SVO & non-SVO 1962-00 (continued)

Gasket Kits



To purchase a complete gasket kit order both top end and bottom end gasket kit

TOP END GASKET KIT

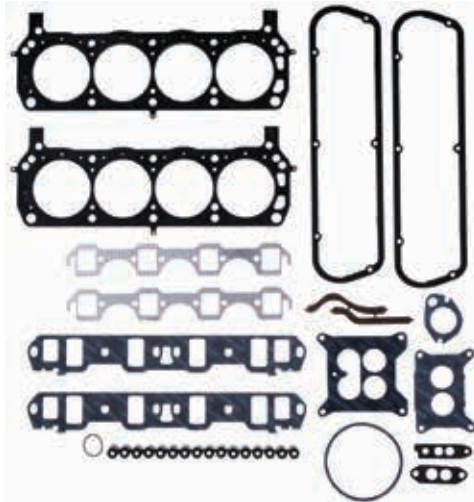

Application	Part No.	Retail
289ci 65-68 & 302ci 68-85 4.100" Bore	PRO1015T	\$287.14
302ci EFI 86-95 4.100" Bore	PRO1016T	\$337.07
351ci Windsor 69-87 4.100" Bore	PRO1013T	\$337.07
351ci Windsor EFI 88-95 4.100" Bore	PRO1014T	\$332.08

BOTTOM END GASKET KIT



Application	Part No.	Retail
289/302ci 65-95	PRO1015B	\$93.51
351ci Windsor 69-95	PRO1013B	\$133.58

Small Block Ford V8 - Aftermarket & Race

Head Gaskets

MLS Head Gaskets-SVO Yates w/Valve Pockets-LHS

Bore	Thickness	Pkg Qty	Part No.	Retail
4.100"	.040"	1	C5358-040	\$97.72
4.180"	.040"	1	C5364-040	\$97.72
4.200"	.040"	1	C5366-040	\$97.72

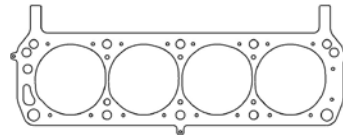

Additional thicknesses available
see pages 2 - 4

MLS Head Gaskets-SVO Yates w/Valve Pockets-RHS

Bore	Thickness	Pkg Qty	Part No.	Retail
4.100"	.040"	1	C5359-040	\$97.72
4.180"	.040"	1	C5365-040	\$97.72
4.200"	.040"	1	C5367-040	\$97.72

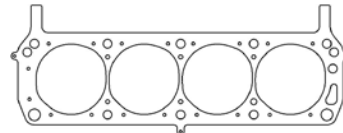

MLS Head Gasket-SVO/Yates w/Valve Pockets

Bore	Thickness	Pkg Qty	Part No.	Retail
4.210"	.040"	1	C15622-040	\$97.72

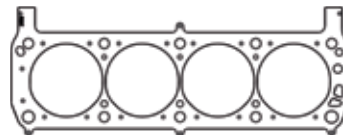

MLS Head Gasket-SVO/Yates w/Valve Pockets - All Active Layers

Bore	Thickness	Pkg Qty	Part No.	Retail
4.210"	.041"	1	C15624-041	\$102.61

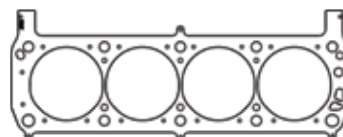

See page 73 for additional gaskets

FORD

Small Block Ford V8 - Aftermarket & Race (continued)

Head Gaskets (continued)

MLS Head Gaskets - Brodix Track 1, Edelbrock RPM Performer, AFR Heads w/Coolant Channels

Bore	Thickness	Pkg Qty	Part No.	Retail
4.030"	.040"	1	C5909-040	\$107.27
4.080"	.040"	1	C5910-040	\$107.27
4.100"	.040"	1	C5911-040	\$107.27
4.155"	.040"	1	C5912-040	\$107.27
4.200"	.040"	1	C5913-040	\$107.27

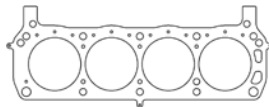

Additional thicknesses available
see pages 2 - 4

MLS Head Gaskets - New Boss 302 Blocks - M-6010-BOSS302 (will not work with OEM non-SVO heads)

Bore	Thickness	Pkg Qty	Part No.	Retail
4.030"	.040"	1	C5958-040	\$97.72
4.080"	.040"	1	C5959-040	\$97.72
4.100"	.040"	1	C5960-040	\$97.72
4.155"	.040"	1	C5961-040	\$97.72
4.200"	.040"	1	C5962-040	\$97.72

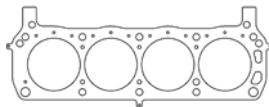

MLX Head Gaskets - New Boss 302 Blocks - M6010-BOSS302 (will not work with OEM non-SVO heads)

Bore	Thickness	Pkg Qty	Part No.	Retail
4.200"	.040"	1	C15373-040	\$125.65

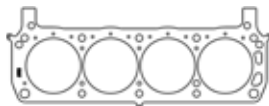

MLS Head Gaskets - Right Side 302/351W '62-'01 SVO Heads with Valve Pocket

Bore	Thickness	Pkg Qty	Part No.	Retail
4.150"	.040"	1	C15551-040	\$97.72

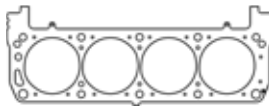

MLS Head Gaskets - Left Side 302/351W '62-'01 SVO Heads with Valve Pocket

Bore	Thickness	Pkg Qty	Part No.	Retail
4.150"	.040"	1	C15552-040	\$97.72

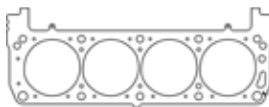

MLS Head Gaskets - World Products Man O'War/Dart Iron Eagle, 10 Degree Heads-6 Bolts per Cylinder

Bore	Thickness	Pkg Qty	Part No.	Retail
4.080"	.040"	1	C5132-040	\$107.27
4.100"	.040"	1	C5133-040	\$107.27
4.155"	.040"	1	C5134-040	\$107.27
4.180"	.040"	1	C5135-040	\$107.27

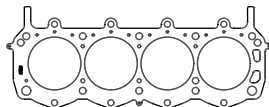

MLS Head Gaskets - Brodix ASCS Head/R452 Block

Bore	Thickness	Pkg Qty	Part No.	Retail
4.125"	.040"	1	C5217-040	\$97.72

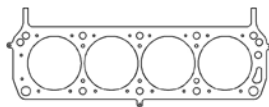

351 Cleveland, 351 Modified, & 400ci V8

Head Gaskets

MLS Head Gaskets

Bore	Thickness	Pkg Qty	Part No.	Retail
4.100"	.040"	1	C5871-040	\$97.72

****WILL NOT WORK WITH CURRENT EDELBROCK 6162 SERIES HEADS****

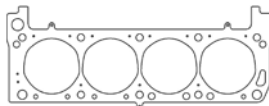

Additional thicknesses available
see pages 2 - 4

Individual Gaskets

Valve Cover Gasket (sold individually)

Application	Part No.	Retail
351C/351M/400 .125" KF	C5659-125	\$41.90

Oil Pan Gasket Set

Application	Part No.	Retail
351C/351M/400 1970-81	C5278-094	\$38.01

See page 74 for additional gaskets



FORD

351 Cleveland, 351 Modified, & 400ci V8 (continued)

Individual Gaskets (continued)

Intake Manifold Gaskets		
Application	Part No.	Retail
351C/351M/400 4bbl Heads	C15102	\$39.56
351C/351M/400 2bbl Heads	C15103	\$39.56

Water Pump Gaskets		
Application	Part No.	Retail
Backing Plate Gasket	C5353	\$11.22
Water Pump Gasket w/Cast Iron Pump	C5662-060	\$10.29

Exhaust Manifold Gasket		
Application	Part No.	Retail
351C/351M/400 4bbl Heads	C15104	\$40.93

Timing Cover Set		
Application	Part No.	Retail
351C/351M/400 1970-81	C5066	\$25.98

Fuel Pump Gasket		
Application	Part No.	Retail
351C/351M/400 .031" Fiber	C15105	\$2.60

Rear Main Seals		
Application	Part No.	Retail
351C/351M/400 - 2pc Poly	C5088	\$11.49
351C/351M/400 - 2pc SN	C5689	\$36.26

Ford RY45 V8

Head Gaskets

MLX Head Gaskets - Right Side				
Bore	Thickness	Pkg Qty	Part No.	Retail
4.290"	.040"	1	C15338-040	\$126.49

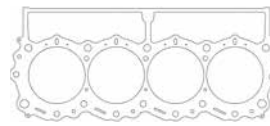

Additional thicknesses available
see pages 2 - 4

MLX Head Gaskets - Left Side				
Bore	Thickness	Pkg Qty	Part No.	Retail
4.290"	.040"	1	C15337-040	\$126.49

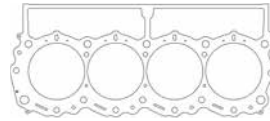

Ford FR9 Race V8

Head Gaskets

MLX Head Gaskets - Right Side				
Bore	Thickness	Pkg Qty	Part No.	Retail
4.190"	.040"	1	C5587-040	\$126.49

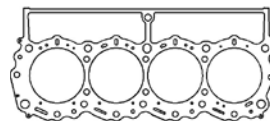

Additional thicknesses available
see pages 2 - 4

MLX Head Gaskets - Left Side				
Bore	Thickness	Pkg Qty	Part No.	Retail
4.190"	.040"	1	C5588-040	\$126.49

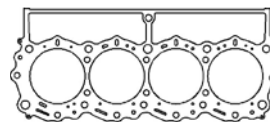

Individual Gaskets

Intake Manifold Gaskets		
Application	Part No.	Retail
FR9 V8 - 2.05" x 1.39" .060" KF	C15106-060	\$38.06

Exhaust Manifold Gaskets		
Application	Part No.	Retail
FR9 V8 - .030" MLS	C15107-030	\$66.95

Ford Flathead V8 1932-53

Head Gaskets

MLS Head Gaskets - 1932-38 21 Bolt				
Bore	Thickness	Pkg Qty	Part No.	Retail
3.156"	.040"	1	C5870-040	\$168.01

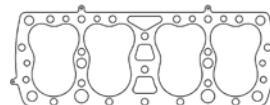

Additional thicknesses available
see pages 2 - 4

MLS Head Gaskets - 1938-48 24 Bolt				
Bore	Thickness	Pkg Qty	Part No.	Retail
3.250"	.051"	1	C5908-051	\$168.01
3.375"	.051"	1	C5108-051	\$168.01

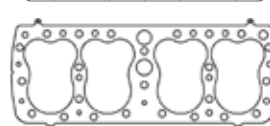

See page 75 for additional gaskets

Ford Flathead V8 1932-53 (continued)

Head Gaskets (continued)

MLS Head Gaskets - 1949-53 24 Bolt - RHS

Bore	Thickness	Pkg Qty	Part No.	Retail
3.375"	.051"	1	C15088-051	\$168.01
3.375"	.092"	1	C15088-092	\$218.34

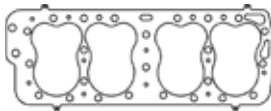

Additional thicknesses available
see pages 2 - 4

MLS Head Gaskets - 1949-53 24 Bolt - LHS

Bore	Thickness	Pkg Qty	Part No.	Retail
3.375"	.051"	1	C15089-051	\$168.01
3.375"	.092"	1	C15089-092	\$218.34

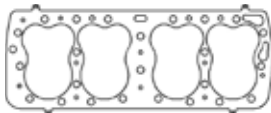

Individual Gaskets

Carburetor Gaskets (sold individually)

Application	Part No.	Retail
Holley Air Cleaner Gasket	C15108	\$3.40
59A, 8BA, 8CM 2bbl Gasket	C15109	\$3.89

Intake Manifold Gaskets

Application	Part No.	Retail
59A 1945-48 .060" KF	C15120	\$39.49
8BA/8CM 1948-53 .060" KF	C15121	\$39.49

Exhaust Manifold Gaskets

Application	Part No.	Retail
59A, 8BA, 8CM 1945-53 8PK	C15116	\$47.68

Distributor Gaskets

Application	Part No.	Retail
59A 45-48 Distributor Base	C15110	\$4.47
59A 45-48 Distributor Cap Cover	C15111	\$3.28
59A Distributor Terminal Housing	C15112	\$2.99
59A 32-41 Distributor Base	C15113	\$4.47
59A 32-41 Distributor Cap Cover	C15114	\$2.99
59A Distributor Coil Base	C15115	\$3.28

Timing Cover Gaskets

Application	Part No.	Retail
59A 1945-48 .015" Fiber	C15134	\$7.14
8BA/8CM 1948-53 .015" Fiber	C15135	\$7.14

Fuel Pump Gaskets

Application	Part No.	Retail
59A 45-48 Fuel Pump Stand	C15117	\$2.08
59A 46-53 Fuel Pump Cover	C15118	\$1.49
8BA/8CM 48-53 Fuel Pump Mount	C15119	\$1.49

Water Pump Gaskets

Application	Part No.	Retail
59A 1945-48 .015" Fiber	C15136	\$5.67
8BA/8CM 1948-53 .015" Fiber	C15137	\$7.14

Oil Pump/Pan Gaskets

Application	Part No.	Retail
59A 32-41 Oil Pump Drive Cover	C15122	\$4.19
59A 45-48 Oil Pump Drive Cover	C15123	\$4.19
59A 45-48 Oil Pump Mounting	C15126	\$1.19
59A 45-48 Oil Pump Screen Cover	C15127	\$1.19
8BA/8CM 48-53 Oil Pump Drive Cover	C15130	\$4.78
8BA/8CM 48-53 Oil Pump Relief Nut	C15132	\$1.19
59A 45-48 Drain Plug Gasket	C15124	\$1.80
59A 1938 Drain Plug Gasket	C15125	\$1.19
8BA/8CM 48-53 Drain Plug Gasket	C15133	\$1.19
8BA/8CM Oil Pan Clean Out	C15128	\$7.44
8BA/8CM Oil Pan Gasket	C15129	\$19.08
8BA/8CM Dipstick Tube Gasket	C15131	\$1.49

352, 390, 406, 410, 427, & 428 FE V8

Head Gaskets

MLS Head Gaskets - Top Oiler

Bore	Thickness	Pkg Qty	Part No.	Retail
4.080"	.040"	1	C5833-040	\$109.94
4.165"	.040"	1	C5834-040	\$109.94
4.250"	.040"	1	C5835-040	\$109.94
4.300"	.040"	1	C5523-040	\$109.94
4.400"	.040"	1	C5840-040	\$109.94

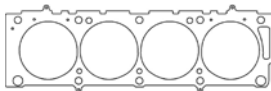

Additional thicknesses available
see pages 2 - 4

MLS Head Gaskets - SOHC Side Oiler

Bore	Thickness	Pkg Qty	Part No.	Retail
4.400"	.040"	1	C5841-040	\$115.44

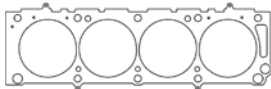

Individual Gaskets

Valve Cover Gaskets (sold individually)

Application	Part No.	Retail
All FE & 428CJ/SCJ	C5138-188	\$25.84
427 SOHC LHS	C15138-188	\$43.00
427 SOHC RHS	C15139-188	\$43.00

Timing Cover Sets

Application	Part No.	Retail
352/360 1958-60	C5067	\$27.46
332-428 1961-71	C5068	\$25.98

See page 76 for additional gaskets



FORD

352, 390, 406, 410, 427, & 428 FE V8 (continued)

Individual Gaskets (continued)

Intake Manifold Gaskets		
Application	Part No.	Retail
STD/Low Riser 428CJ/SCJ 1.408" x 2.345" Rectangle Port	C5137-060	\$35.32
427 SOHC	C15140-060	\$38.96

Exhaust Manifold Gaskets		
Application	Part No.	Retail
352-410 FE & 428CJ/SCJ 1.560" x 2.310" Rectangle Port MLS	C5922-030	\$54.58
427 SOHC .064" AM	C15141-064	\$28.14

Oil Pan Gasket		
Application	Part No.	Retail
FE V8 1961-71	C5141-125	\$26.71

Rear Main Seal		
Application	Part No.	Retail
FE V8 1961-71	C5142	\$31.07

Water Pump Gaskets		
Application	Part No.	Retail
FE V8 1961-71 (Pair)	C5140-031	\$4.56

Gasket Kits



To purchase a complete gasket kit order both top end and bottom end gasket kit

TOP END GASKET KIT

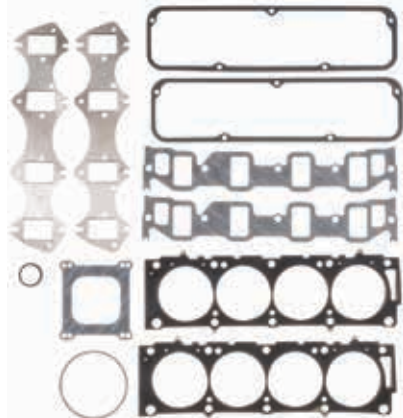

Application	Part No.	Retail
352, 390, 410, 428 FE V8 4.300" Bore	PRO1027T	\$219.72

BOTTOM END GASKET KIT



Application	Part No.	Retail
352, 390, 410, 428 FE V8	PRO1027B	\$74.80

370ci 6.1L, 429ci 7.0L, 460ci 7.5L Big Block V8

Head Gaskets

MLS Head Gaskets				
Bore	Thickness	Pkg Qty	Part No.	Retail
4.175"	.049"	1	C15655-049	\$154.86
4.400"	.040"	1	C5666-040	\$107.27
4.440"	.040"	1	C15400-049	\$107.27
4.500"	.040"	1	C5667-040	\$107.27
4.600"	.040"	1	C15142-040	\$107.27
4.670"	.040"	1	C5668-040	\$107.27

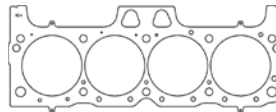

Additional thicknesses available
see pages 2 - 4

Copper Head Gaskets				
Bore	Thickness	Pkg Qty	Part No.	Retail
4.520"	.043"	1	C15421-043	\$143.67

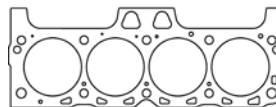

Individual Gaskets

Valve Cover Gaskets (sold individually)		
Application	Part No.	Retail
429/460 Big Block Molded Rubber	C15467	\$36.29
429/460 Big Block .125" KF	C5205-125	\$37.49

Intake Manifold Gaskets		
Application	Part No.	Retail
Stock 429/460 Heads 1.980" x 2.260" Oval Port	C5043-060	\$38.96
CJ/SCJ 2.240" x 2.613" Oval Ports	C5206-060	\$37.08

See page 77 for additional gaskets

FORD

370ci 6.1L, 429ci 7.0L, 460ci 7.5L Big Block V8 (continued)

Individual Gaskets (continued)

Exhaust Manifold Gaskets

Application	Part No.	Retail
429/460 1.280" x 2.040" Oval Port - .030" MLS	C5900-030	\$52.01

Oil Pan Gasket

Application	Part No.	Retail
429/460 4 pc set	C5125-094	\$45.26

Water Pump Gaskets

Application	Part No.	Retail
429/460 Big Block	C5209-031	\$14.61

Timing Cover Set

Application	Part No.	Retail
429/460 1968-85	C5069	\$25.98

Rear Main Seal

Application	Part No.	Retail
429/460 Big Block 2pc	C5208	\$19.38

Gasket Kits



To purchase a complete gasket kit order both top end and bottom end gasket kit

TOP END GASKET KIT

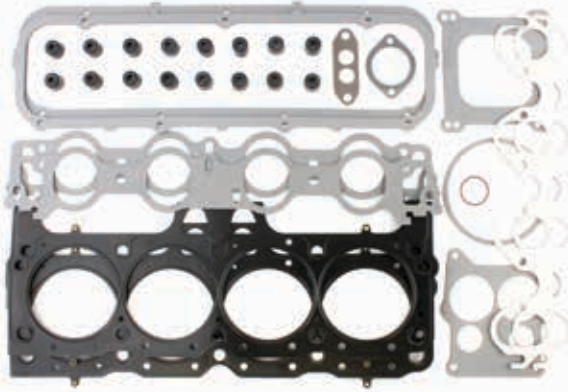

Application	Part No.	Retail
429/460ci Big Block V8 68-78 4.500" Bore	PRO1012T	\$282.15

BOTTOM END GASKET KIT

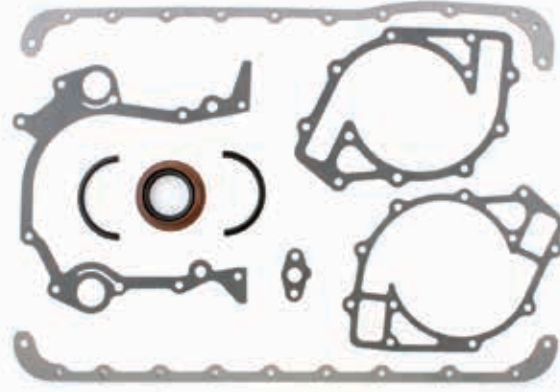

Application	Part No.	Retail
429/460ci Big Block V8 68-78	PRO1012B	\$81.48

Pro Stock Racing V8

Head Gaskets

MLS Head Gaskets - D/E460 PRO STOCK

Bore	Thickness	Pkg Qty	Part No.	Retail
4.600"	.045"	1	C5731-045	\$149.23
4.685"	.045"	1	C5732-045	\$149.23

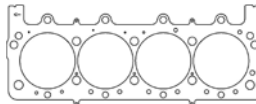

Additional thicknesses available
see pages 2 - 4

MLS Head Gaskets - A460/C460 PRO STOCK

Bore	Thickness	Pkg Qty	Part No.	Retail
4.500"	.045"	1	C15446-045	\$149.23
4.600"	.045"	1	C5743-045	\$149.23
4.685"	.045"	1	C5744-045	\$149.23

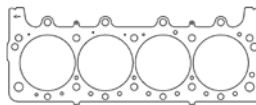

MLS Head Gaskets - A500 PRO STOCK - LHS

Bore	Thickness	Pkg Qty	Part No.	Retail
4.600"	.045"	1	C5727-045	\$149.23
4.685"	.045"	1	C5729-045	\$149.23

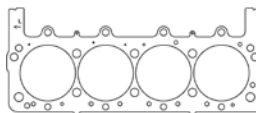

See page 78 for additional gaskets



FORD

Pro Stock Racing V8 (continued)

Head Gaskets (continued)

MLS Head Gaskets - A500 PRO STOCK - RHS

Bore	Thickness	Pkg Qty	Part No.	Retail
4.600"	.045"	1	C5728-045	\$149.23
4.685"	.045"	1	C5730-045	\$149.23

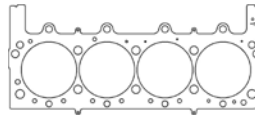

Additional thicknesses available
see pages 2 - 4

MLS Head Gaskets - 460 w/Hemi 14 Bolt Head

Bore	Thickness	Pkg Qty	Part No.	Retail
4.700"	.040"	1	C5888-040	\$142.12

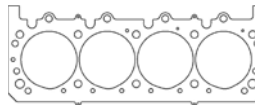

MLS Head Gaskets - JC50 500ci PRO STOCK - LHS

Bore	Thickness	Pkg Qty	Part No.	Retail
4.735"	.052"	1	C5284-052	\$184.80

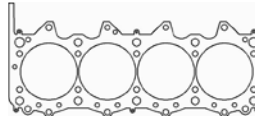

MLS Head Gaskets - JC50 500ci PRO STOCK - RHS

Bore	Thickness	Pkg Qty	Part No.	Retail
4.735"	.052"	1	C5285-052	\$184.80

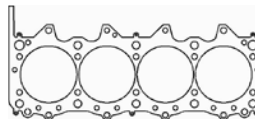

MLS Head Gaskets - 800ci W/5.0" Bore Centers

Bore	Thickness	Pkg Qty	Part No.	Retail
4.770"	.040"	1	C5875-040	\$107.27
4.770"	.051"	1	C5875-051	\$112.63

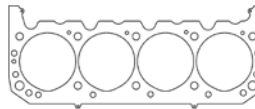

Individual Gaskets

Exhaust Manifold Gaskets

Application	Part No.	Retail
JC50 500ci - 2.200" Round Port .030" MLS	C5257-030	\$66.95

6.2L SOHC Raptor 2010-13

Head Gasket

MLX Head Gaskets - LHS

Bore	Thickness	Pkg Qty	Part No.	Retail
4.125"	0.054	1	C15430-054	\$191.03

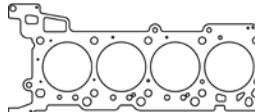

Additional thicknesses available
see pages 2 - 4

MLX Head Gasket - RHS

Bore	Thickness	Pkg Qty	Part No.	Retail
4.125"	0.054	1	C15429-054	\$191.03

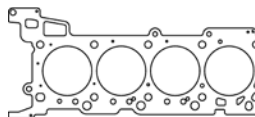

6.8L 3v Modular V10

Head Gaskets

MLX Head Gaskets - Right Side

Bore	Thickness	Pkg Qty	Part No.	Retail
92.5mm	.040"	1	C15462-040	\$126.49

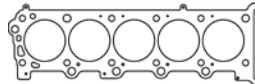

Additional thicknesses available
see pages 2 - 4

MLX Head Gaskets - Left Side

Bore	Thickness	Pkg Qty	Part No.	Retail
92.5mm	.040"	1	C15461-040	\$126.49

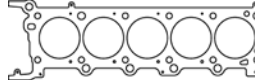

FORD

Ford 7.3L Godzilla V8 2020-22

Head Gaskets

HP Head Gaskets - Right Side				
Bore	Thickness	Pkg Qty	Part No.	Retail
109mm	.040"	1	C15660-040	\$147.49

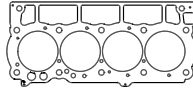

Additional thicknesses available
see pages 2 - 4

HP Head Gaskets - Left Side				
Bore	Thickness	Pkg Qty	Part No.	Retail
109mm	.040"	1	C15661-040	\$147.49

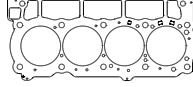

NEW!

Individual Gaskets

Exhaust Manifold Gasket			
Application	Part No.	Retail	
7.3L Godzilla V8 2020-22, .060" HT Set	C15664	\$23.81	
7.3L Godzilla V8 2020-22, .040" MLS Set	C15664-040	\$84.58	

6.0L Power Stroke Diesel 2003-08

Head Gaskets

MLX Head Gaskets - 2003-06 18mm Dowels				
Bore	Thickness	Pkg Qty	Part No.	Retail
96mm	.062"	1	C5589-062	\$166.31

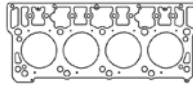

Additional thicknesses available
see pages 2 - 4

MLX Head Gaskets - 2007-08 20mm Dowels				
Bore	Thickness	Pkg Qty	Part No.	Retail
96mm	.062"	1	C5984-062	\$166.31

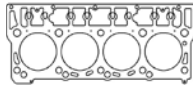

Individual Gaskets

Valve Cover Gasket Set			
Application	Part No.	Retail	
6.0L Power Stroke 03-08	C15143	\$157.34	

HPOP Cover Gasket			
Application	Part No.	Retail	
6.0L Power Stroke 03-08	C15145	\$32.70	

Intake Manifold Gasket Set			
Application	Part No.	Retail	
6.0L Power Stroke 03-08	C15144	\$126.26	

Oil Cooler O-Ring Kit			
Application	Part No.	Retail	
6.0L Power Stroke 03-08	C15146	\$154.63	

Throttle Body Gasket			
Application	Part No.	Retail	
6.0L Power Stroke 03-08	C15153	\$9.31	

Cylinder Head Dowels (sold individually)			
Application	Part No.	Retail	
6.0L Power Stroke 03-06 18mm	C15147	\$19.16	
6.0L Power Stroke 07-08 20mm	C15148	\$15.75	

Exhaust Manifold Gasket			
Application	Part No.	Retail	
6.0L Power Stroke 03-08 - MLS	C5089-030	\$57.04	

Valve Stem Seals (sold individually)			
Application	Part No.	Retail	
6.0L Power Stroke 03-08 (Req 32)	3217V	\$4.73	

Gasket Kits

STREETPRO
by Cometic Gasket

To purchase a complete gasket kit order both top end and bottom end gasket kit

TOP END GASKET KIT

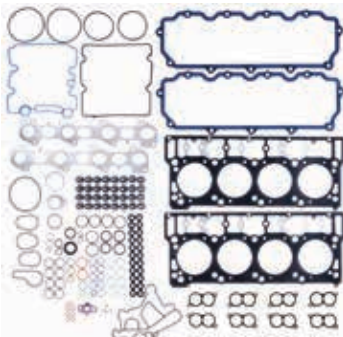

Application	Part No.	Retail
6.0L Power Stroke 03-06 96mm Bore	PRO3005T	\$910.07
6.0L Power Stroke 07-08 96mm Bore	PRO3006T	\$910.07

BOTTOM END GASKET KIT

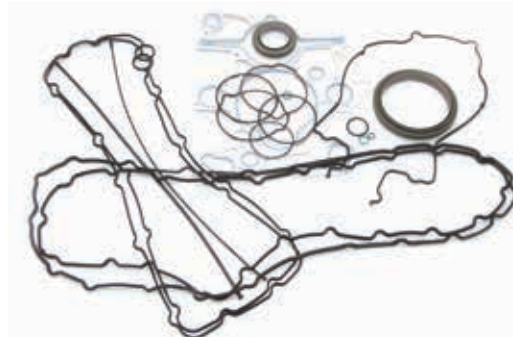

Application	Part No.	Retail
6.0L Power Stroke 03-08	PRO3005B	\$169.35



FORD

6.4L Power Stroke Diesel 2008-2010

Head Gasket

MLX Head Gasket

Bore	Thickness	Pkg Qty	Part No.	Retail
103mm	.062"	1	C5610-062	\$166.31
103mm	.067"	1	C5610-067	\$166.31

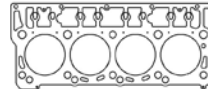

Additional thicknesses available
see pages 2 - 4

MLX Head Gasket - REV B

Bore	Thickness	Pkg Qty	Part No.	Retail
103mm	.062"	1	C15175-062	\$166.31

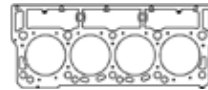

Individual Gaskets

Valve Cover Gasket Set

Application	Part No.	Retail
6.4L Power Stroke 08-10	C15151	\$122.35

Turbo Mounting Kit

Application	Part No.	Retail
6.4L Power Stroke 08-10	C15154	\$147.44

Intake Manifold Gasket Set

Application	Part No.	Retail
6.4L Power Stroke 08-10	C15152	\$44.82

Fuel Injector Seal Kit

Application	Part No.	Retail
6.4L Power Stroke 08-10 (pack of 8)	C15155	\$29.00

Exhaust Manifold Gasket

Application	Part No.	Retail
6.4L Power Stroke 08-10 - MLS	C5089-030	\$57.04

Oil Cooler Mounting Kit

Application	Part No.	Retail
6.4L Power Stroke 08-10	C15156	76.48

Valve Stem Seals (sold individually)

Application	Part No.	Retail
6.4L Power Stroke 08-10 (Req 32)	3217V	\$4.73

Cylinder Head Dowels (sold each)

Application	Part No.	Retail
6.4L Power Stroke 08-10 20mm	C15148	\$15.75

Throttle Body Gasket

Application	Part No.	Retail
6.0L Power Stroke 08-10	C15153	\$9.31

Cooling/Water Pump Gaskets

Application	Part No.	Retail
Thermostat Housing Seal	C15157	\$6.96
Lower Coolant Hose Gasket	C15158	\$7.86
Upper Coolant Hose Gasket	C15159	\$7.21

Gasket Kits



To purchase a complete gasket kit order both top end and bottom end gasket kit

TOP END GASKET KIT

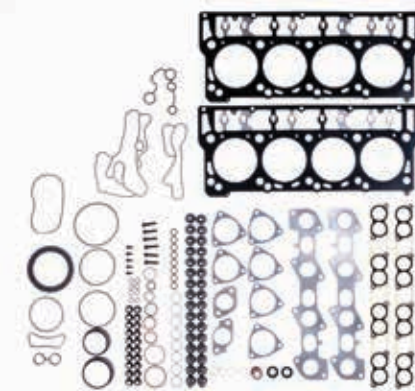

Application	Part No.	Retail
6.4L Power Stroke 08-10 99mm Bore	PRO3007T	\$910.07

BOTTOM END GASKET KIT

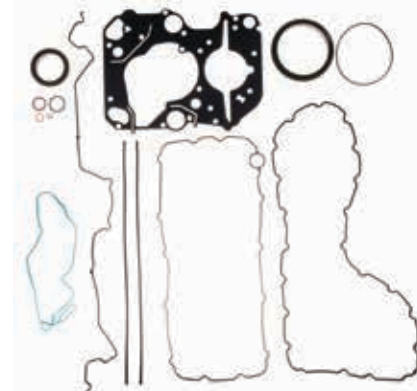

Application	Part No.	Retail
6.4L Power Stroke 08-10	PRO3007B	\$222.52

FORD

6.7L Power Stroke Scorpion Diesel 2011-17

Head Gaskets

MLX Head Gaskets - RHS

Bore	Thickness	Pkg Qty	Part No.	Retail
100mm	.053"	1	C15160-053	\$166.31
100mm	.062"	1	C15160-062	\$166.31

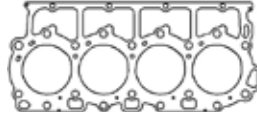

Additional thicknesses available
see pages 2 - 4

MLX Head Gaskets - LHS

Bore	Thickness	Pkg Qty	Part No.	Retail
100mm	.053"	1	C15161-053	\$166.31
100mm	.062"	1	C15161-062	\$166.31

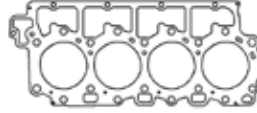

Individual Gaskets

Exhaust Manifold Gaskets

Application	Part No.	Retail
6.7L Power Stroke Scorpion MLS	C15487-030	\$50.52

Oil Pan Gaskets

Application	Part No.	Retail
.060" AFM Material	C15466-060	\$24.07

Gasket Kits



To purchase a complete gasket kit order both top end and bottom end gasket kit

BOTTOM END GASKET KIT

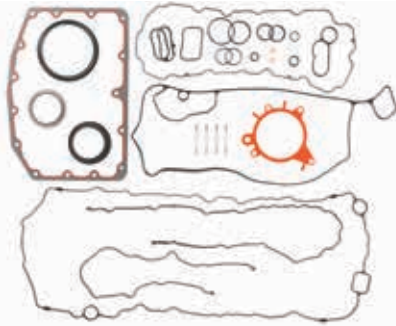

Application	Part No.	Retail
6.7L Power Stroke Scorpion 2011-2014	PRO3013B	\$220.89

7.3L Power Stroke Diesel 1994-03

Head Gasket

MLS Head Gasket

Bore	Thickness	Pkg Qty	Part No.	Retail
4.140"	.066"	1	C5839-066	\$166.31

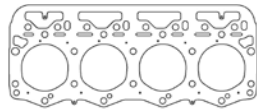

Additional thicknesses available
see pages 2 - 4

MLX Head Gasket

Bore	Thickness	Pkg Qty	Part No.	Retail
4.140"	.067"	1	C15390-067	\$166.31

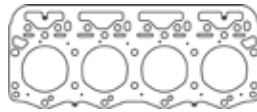

Individual Gaskets

Valve Cover Gaskets (sold individually)

Application	Part No.	Retail
7.3L Power Stroke 94-97	C15162	\$136.50
7.3L Power Stroke 98-03	C15163	\$168.19

HPOP Gaskets

Application	Part No.	Retail
7.3L Power Stroke 94-95	C15164	\$22.00
7.3L Power Stroke 96-03	C15165	\$22.00

Valve Stem Seals (sold individually)

Application	Part No.	Retail
7.3L Power Stroke (need 16)	3216V	\$4.34

Intake Manifold Gasket Set

Application	Part No.	Retail
7.3L Power Stroke .060" AFM 96-03 10 Bolt	C5090-060	\$33.86
7.3L Power Stroke .060" AFM 94-95 8 Bolt	C15681-060	\$34.13

Exhaust Manifold Gaskets

Application	Part No.	Retail
7.3L Power Stroke .064" AM	C5091-064	\$42.26

See page 82 for StreetPro gasket kits



FORD

7.3L Power Stroke Diesel 1994-03 (continued)

Gasket Kits



To purchase a complete gasket kit order both top end and bottom end gasket kit

TOP END GASKET KIT

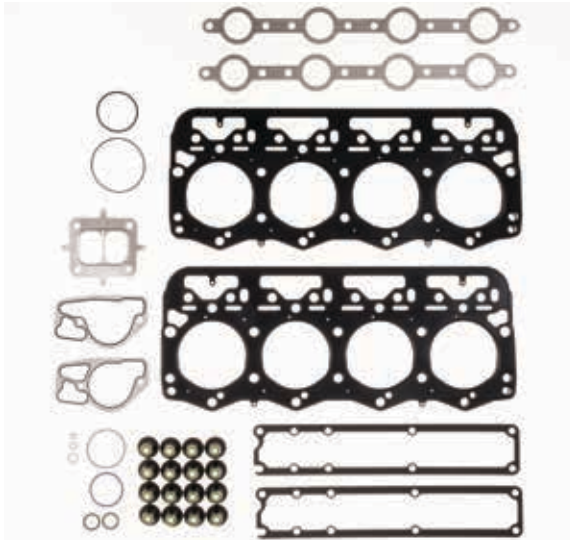

Application	Part No.	Retail
7.3L Power Stroke 1994-03 4.140" Bore	PRO3010T	\$520.55

BOTTOM END GASKET KIT



Application	Part No.	Retail
7.3L Power Stroke 1994-03	PRO3010B	\$230.88

OLDSMOBILE / GM

330, 350, 400, 403, & 455ci V8

Head Gasket

MLS Head Gaskets

Bore	Thickness	Pkg Qty	Part No.	Retail
4.125"	.040"	1	C5808-040	\$109.94
4.200"	.040"	1	C5809-040	\$109.94
4.270"	.040"	1	C5811-040	\$109.94
4.400"	.040"	1	C5810-040	\$109.94

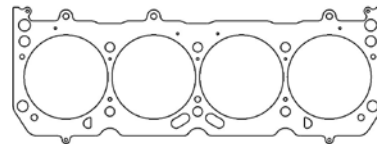

Additional thicknesses available see pages 2 - 4

Individual Gaskets

Valve Cover Gasket (sold individually)

Application	Part No.	Retail
330-455ci Olds V8 .188" Molded Rubber	C15440	\$25.98

Timing Cover Set

Application	Part No.	Retail
330-455ci Olds V8 1964-90	C5070	\$27.46

Intake Manifold Gaskets

Application	Part No.	Retail
330, 350, & 403 Small V8 1.370" x 2.040" Rectangle Port	C5216-030	\$30.94
400 & 455 Big V8 1.450" x 2.500" Rectangle Port	C5813-060	\$30.94

Exhaust Manifold Gaskets

Application	Part No.	Retail
330-455ci V8 Stock Port .064" AM	C5812-064	\$35.14
330-455ci V8 1.456" x 1.913", 1.448" x 1.913" Rectangle Port MLS	C5904-030	\$50.77

Oil Pan Gasket Kit

Application	Part No.	Retail
330-455ci Olds V8 4pc Kit	C5822-094	\$38.60

Water Pump Gaskets

Application	Part No.	Retail
330-455ci V8 1968-76 w/AC	C15166	\$9.88
330-455ci V8 1964-90	C15167	\$9.88

See page 83 for StreetPro gasket kits



OLDSMOBILE / GM

330, 350, 400, 403, & 455ci V8 (continued)

Gasket Kits



To purchase a complete gasket kit order both top end and bottom end gasket kit

TOP END GASKET KIT

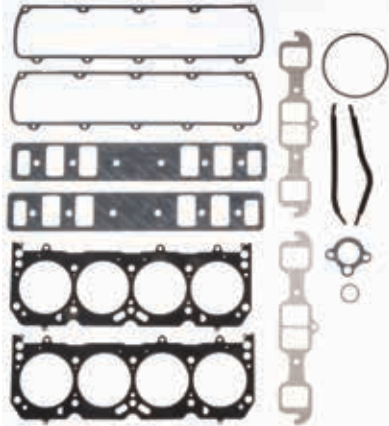

Application	Part No.	Retail
Olds 455ci V8 1968-76 4.200" Bore	PRO1009T	\$244.68

BOTTOM END GASKET KIT



Application	Part No.	Retail
Olds 455ci V8 1968-76	PRO1009B	\$85.72

370/371 J-2 Golden Rocket 1957-60

Head Gaskets

MLS Head Gaskets

Bore	Thickness	Pkg Qty	Part No.	Retail
4.190"	.040"	1	C5129-040	\$109.94

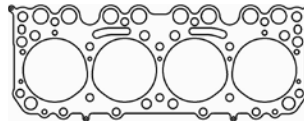

Additional thicknesses available see pages 2 - 4

Individual Gaskets

Intake Manifold Gaskets

Application	Part No.	Retail
370/371 J-2 Golden Rocket .060" KF	C5130-060	\$42.90

Exhaust Manifold Gasket Set

Application	Part No.	Retail
370/371 J-2 Golden Rocket .059" CFM	C5131-059	\$34.79

PONTIAC / GM

389 & 421ci V8

Head Gaskets

MLS Head Gaskets-389 (63-67) & 421 (63-66) 400 (66-67)

Bore	Thickness	Pkg Qty	Part No.	Retail
4.300"	.040"	1	C15262-040	\$109.94
4.300"	.060"	1	C15262-060	\$156.98
4.300"	.080"	1	C15262-080	\$169.66

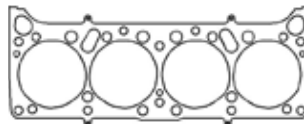

Additional thicknesses available see pages 2 - 4

326, 350, 400, 428, & 455ci V8

Head Gaskets

MLS Head Gasket-326 (63-67) 350 (68-77)

Bore	Thickness	Pkg Qty	Part No.	Retail
3.750"	.040"	1	C5767-040	\$109.94
3.950"	.040"	1	C5710-040	\$109.94

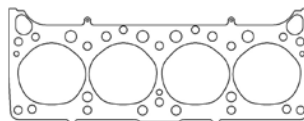

Additional thicknesses available see pages 2 - 4

See page 84 for additional gaskets



PONTIAC / GM

326, 350, 400, 428, & 455ci V8 (continued)

Head Gaskets (continued)

MLS Head Gaskets-400 (68-79), 428 (68-69), 455 (70-76)				
Bore	Thickness	Pkg Qty	Part No.	Retail
4.160"	.040"	1	C5711-040	\$109.94
4.200"	.040"	1	C5769-040	\$109.94
4.300"	.040"	1	C5712-040	\$109.94
4.380"	.040"	1	C5846-040	\$109.94
4.410"	.040"	1	C5847-040	\$109.94

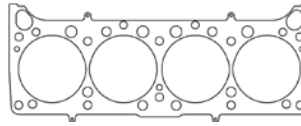

Additional thicknesses available
see pages 2 - 4

Individual Gaskets

Molded Rubber Valve Cover Gaskets (sold individually)		
Application	Part No.	Retail
All Models w/Stock Heads	C5044	\$25.98

Timing Cover Set		
Application	Part No.	Retail
265-455ci V8 193-81	C5071	\$32.46

Intake Manifold Gaskets		
Application	Part No.	Retail
400, 428, & 455ci 1.141" x 2.063" Rectangle Port .060" KF	C5778-060	\$30.94
326-455ci .060" HTS w/o EGR	C15197-060	\$31.02

Exhaust Manifold Gaskets		
Application	Part No.	Retail
400, 428, & 455ci .064" AM	C5147-064	\$28.13
400, 428, & 455ci 1.500" x 1.930", 1.150" x 1.930" Split Center Port MLS	C5905-030	\$50.77

Oil Pan Gasket Kit		
Application	Part No.	Retail
400, 428, & 455ci 4 pc kit	C5176-094	\$22.53

Water Pump Gasket		
Application	Part No.	Retail
400, 428, & 455ci .031" Fiber	C5149-031	\$12.34

Gasket Kits



To purchase a complete gasket kit order both top end and bottom end gasket kit

TOP END GASKET KIT



Application	Part No.	Retail
Big Block 455ci 7.5L 1970-76 4.200" Bore	PRO1010T	\$234.27

BOTTOM END GASKET KIT

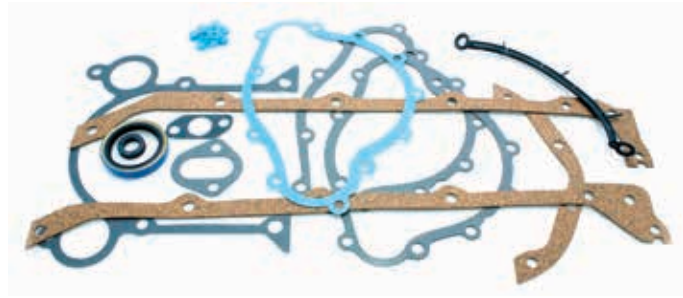

Application	Part No.	Retail
Big Block 455ci 7.5L 1970-76	PRO1010B	\$53.41

AUSTIN

1000cc 4 Cylinder 1958-65 Healey Sprite Mark I & II

Head Gasket

Copper Head Gasket

Bore	Thickness	Pkg Qty	Part No.	Retail
67.5mm	.043"	1	C4145-043	\$95.53

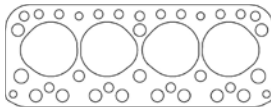

Additional thicknesses available
see pages 2 - 4

1300cc 4 Cylinder Austin Mini

Head Gasket

Copper Head Gasket

Bore	Thickness	Pkg Qty	Part No.	Retail
72mm	.030"	1	C14046-030	\$107.24
72.5mm	.030"	1	C14073-030	\$107.24
73mm	.030"	1	C4146-030	\$107.24
73.5mm	.030"	1	C14038-030	\$107.24

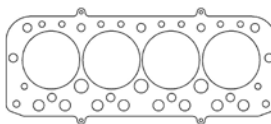

Additional thicknesses available
see pages 2 - 4

BMW

M10 4 Cylinder

Head Gaskets

MLS Head Gasket - 1573/1773cc M116/M118 1963-77

Bore	Thickness	Pkg Qty	Part No.	Retail
86mm	.051"	1	C4292-051	\$168.92

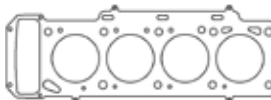

Additional thicknesses available
see pages 2 - 4

MLS Head Gasket - 1766/1990cc M10B18/M10B20 1975-88

Bore	Thickness	Pkg Qty	Part No.	Retail
90mm	.051"	1	C4293-051	\$168.92

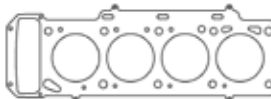

Individual Gaskets

Valve Cover Gasket

Application	Part No.	Retail
BMW M10B18/B20 .125" Cork	C4794-125	\$10.11

Oil Pan Gasket

Application	Part No.	Retail
BMW M10B18/B20 .062" KF	C4796-062	\$33.17

Intake Manifold Gasket Set

Application	Part No.	Retail
BMW M10B18/B20 .060" KF	C4793	\$16.59

Rear Main Seal

Application	Part No.	Retail
BMW M10B18/B20	C4797	\$51.59

Exhaust Manifold Gasket Set

Application	Part No.	Retail
BMW M10B18/B20 .064" AM	C4883	\$16.17

Thermostat Gasket

Application	Part No.	Retail
BMW M10B18/B20 .031" Fiber	C4795-031	\$2.08

Gasket Kits

To purchase a complete gasket kit order both top end and bottom end gasket kit

TOP END GASKET KIT

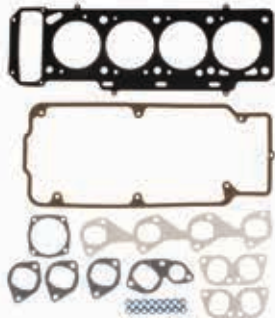

Application	Part No.	Retail
M10 1.8/2.0L 1966-88 90mm Bore	PRO2027T	\$258.18

BOTTOM END GASKET KIT



Application	Part No.	Retail
M10 1.8/2.0L 1966-88	PRO2027B	\$80.72



BMW

M42 1.8L, M44 1.9L 318is 1989-00, 318ti 1992-00, Z3 1996-01

Head Gaskets

MLS Head Gaskets

Bore	Thickness	Pkg Qty	Part No.	Retail
85mm	.060"	1	C4348-060	\$204.44
86mm	.060"	1	C4349-060	\$204.44

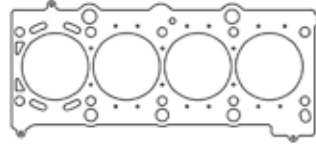

Additional thicknesses available
see pages 2 - 4

Individual Gaskets

Exhaust Manifold Gasket Set

Application	Part No.	Retail
M42B18/M44B18 .060" HTS	C14130-060	\$18.91

S14B20 1990cc 1986-91, S14B23 2302cc 1986-91 M3 86-91, 320is 1988-91

Head Gaskets

MLS Head Gaskets

Bore	Thickness	Pkg Qty	Part No.	Retail
93.4mm	.051"	1	C4294-051	\$168.92
94.5mm	.051"	1	C4295-051	\$168.92

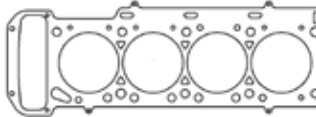

Additional thicknesses available
see pages 2 - 4

M50B20/M50B20TU 2.0L 1989-98 320i 1991-95, 520i 1991-95

Head Gasket

MLS Head Gasket

Bore	Thickness	Pkg Qty	Part No.	Retail
82mm	.070"	1	C4332-070	\$272.56

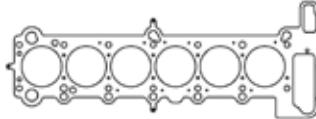

Additional thicknesses available
see pages 2 - 4

M54B22 2.2L 1999-Up 320i, 320ci, 520i 2000-03, Z3 2001-02, Z4 2003-Up

Head Gasket

MLS Head Gasket

Bore	Thickness	Pkg Qty	Part No.	Retail
81mm	.030"	1	C4351-030	\$201.10

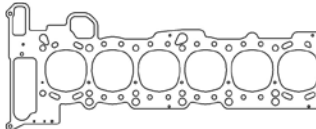

Additional thicknesses available
see pages 2 - 4

M20B20 SOHC 12v 2.0L Inline 6 320 1977-82, 520 1977-81

Head Gasket

MLS Head Gasket

Bore	Thickness	Pkg Qty	Part No.	Retail
81mm	.070"	1	C4393-070	\$272.56

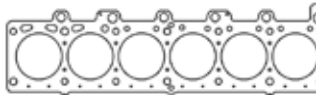

Additional thicknesses available
see pages 2 - 4

M20B25/27 SOHC 12v 2.5/2.7L Inline 6 323i 1977-86, Z1 1988-93, 525e 1983-87, 528e 1981, 325e 1983-87

Head Gasket

MLS Head Gasket

Bore	Thickness	Pkg Qty	Part No.	Retail
85mm	.070"	1	C4394-070	\$272.56

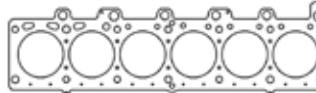

Additional thicknesses available
see pages 2 - 4

See page 87 for additional gaskets

BMW

M20B25/27 SOHC 12v 2.5/2.7L Inline 6 323i 1977-86, Z1 1988-93, 525e 1983-87, 528e 1981, 325e 1983-87 (continued)

Individual Gaskets

Valve Cover Gasket		
Application	Part No.	Retail
BMW M20 2.5/2.7L .059" CFM	C4800-059	\$38.59

Intake Manifold Gasket Set		
Application	Part No.	Retail
325e 1984-87 Small Port	C4884	\$11.73
325/325is 87-93 Normal Ports	C4885	\$15.24

Exhaust Manifold Gasket Set		
Application	Part No.	Retail
BMW M20 2.5/2.7L .064" AM	C4798-064	\$16.38

Thermostat Gasket		
Application	Part No.	Retail
BMW M20 2.5/2.7L	C4799	\$9.12

Oil Pan Gasket		
Application	Part No.	Retail
BMW M20 2.5/2.7L	C4801-060	\$24.26

Rear Main Seal		
Application	Part No.	Retail
BMW M20 2.5/2.7L	C4802	\$26.48

Timing Cover Set		
Application	Part No.	Retail
BMW M20 2.5/2.7L	C4803	\$13.84

Water Pump Gasket		
Application	Part No.	Retail
BMW M20 2.5/2.7L .020" Fiber	C4804-020	\$2.82

Gasket Kits



To purchase a complete gasket kit order both top end and bottom end gasket kit

TOP END GASKET KIT

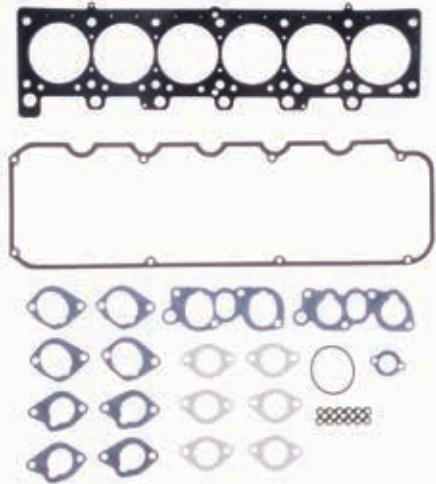

Application	Part No.	Retail
BMW M20 2.5/2.7L 85mm Bore	PRO2028T	\$324.49

BOTTOM END GASKET KIT

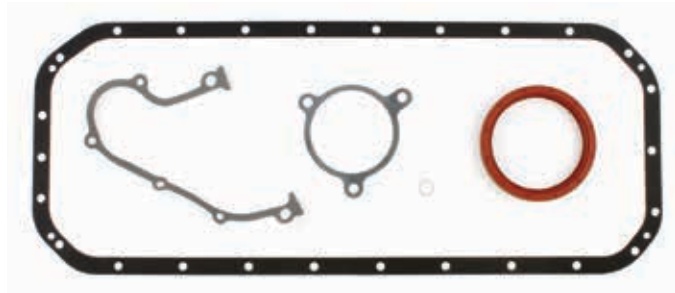

Application	Part No.	Retail
BMW M20 2.5/2.7L	PRO2028B	\$66.15

M30B25V/M30B25/M30B28V/M30B28 2.5/2.8L Inline 6, 628Csi 79-81, 525 73-78, 525i 78-81, 525 73-81

Head Gasket

MLS Head Gasket				
Bore	Thickness	Pkg Qty	Part No.	Retail
88mm	.070"	1	C4475-070	\$224.22

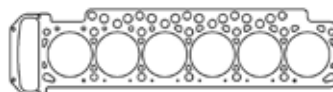

Additional thicknesses available see pages 2 - 4



BMW

M50B25/28 2.5/2.8L Inline 6, 328i 95-00, 528i 95-99, 728i 95-99, Z3 97-99, 325i 91-95, 525i 92-95, 525ix 92-95

Head Gasket

MLS Head Gasket				
Bore	Thickness	Pkg Qty	Part No.	Retail
85mm	.070"	1	C4328-070	\$272.56
85mm	.092"	1	C4328-092	\$291.66
85mm	.140"	1	C4328-140	\$308.34

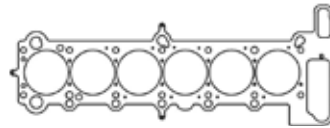

Additional thicknesses available
see pages 2 - 4

MLX Head Gasket				
Bore	Thickness	Pkg Qty	Part No.	Retail
85mm	.067"	1	C14010-067	\$268.18
85mm	.073"	1	C14010-073	\$268.18
85mm	.142"	1	C14010-142	\$308.34

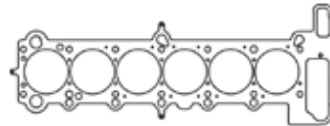

Individual Gaskets

Exhaust Header Gasket Set		
Application	Part No.	Retail
M50B25/28 .060" HTS	C14128-060	\$28.36

Timing Cover		
Application	Part No.	Retail
M50B25 .020" Fiber	C14129	\$10.97

M54tuB25/B28 2.5/2.8L & M52B25/M54B30 325i 01-05, 325xi 01-05, 325Ci 01-06, 525i 01-03, Z3 01-06, X5 01-06

Head Gasket

MLS Head Gasket				
Bore	Thickness	Pkg Qty	Part No.	Retail
85mm	.030"	1	C4352-030	\$201.10

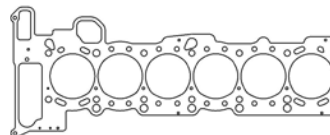

Additional thicknesses available
see pages 2 - 4

M30B30/B32 3.0/3.2L Inline 6 630CS 1979, 633 CSi 76-84

Head Gasket

MLS Head Gasket				
Bore	Thickness	Pkg Qty	Part No.	Retail
90mm	.070"	1	C4476-070	\$224.22

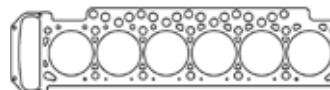

Additional thicknesses available
see pages 2 - 4

S50B30/S52B32 3.0/3.2L Inline 6 (E36) M3 94-99, Z3 M Roadster 98-00, Z3 M Coupe 99-00 (US Spec ONLY)

Head Gaskets

MLS Head Gasket				
Bore	Thickness	Pkg Qty	Part No.	Retail
87mm	.066"	1	C4329-066	\$272.56
87mm	.070"	1	C4329-070	\$272.56
87mm	.075"	1	C4329-075	\$272.56

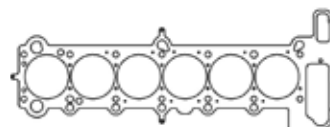

Additional thicknesses available
see pages 2 - 4

Individual Gaskets

Exhaust Manifold Gasket Set		
Application	Part No.	Retail
M52/S52	C14131-060	\$28.67

S50B30/S52B32 3.0/3.2L Inline 6 (E36) M3 1992-00 (Euro Models Only)

Head Gaskets

MLS Head Gasket

Bore	Thickness	Pkg Qty	Part No.	Retail
87mm	.066"	1	C4508-066	\$272.56
87mm	.070"	1	C4508-070	\$272.56
87mm	.075"	1	C4508-075	\$272.56

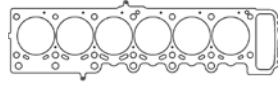

Additional thicknesses available
see pages 2 - 4

N54B30 3.0L Inline 6 (E60) 535i 2007-10, (E90 / E91 / E92 / E93) 335i 2007-10, (E82 / E88) 135i 2007-10, X6 2008-10, Z4 2009-16

Head Gaskets

MLX Head Gasket

Bore	Thickness	Pkg Qty	Part No.	Retail
85mm	.044"	1	C15257-044	\$215.84
85mm	.048"	1	C15257-048	\$268.18
85mm	.052"	1	C15257-052	\$268.18

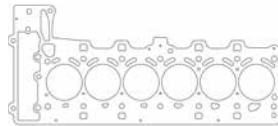

Additional thicknesses available
see pages 2 - 4

N55B30/N55B30M0/N55B3000/N55B30T0/N55HP 3.0L Inline 6 335i 2011-16, 435i 2014-16, 535i 11-17, M2 2014-17, X6 2011-17

Head Gasket

MLX Head Gasket

Bore	Thickness	Pkg Qty	Part No.	Retail
85mm	.059"	1	C15476-044	\$215.84

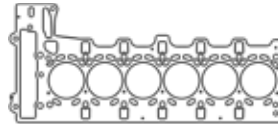

Additional thicknesses available
see pages 2 - 4

S54B32 3.2L Inline 6 M3 (E46) 2001-06, Z3 (E36) 2001-02, Z4 (E85) 2006-Up

Head Gasket

MLS Head Gasket

Bore	Thickness	Pkg Qty	Part No.	Retail
87.5mm	.070"	1	C4505-070	\$240.83

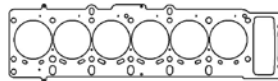

Additional thicknesses available
see pages 2 - 4

S55B30T0 3.0L Inline 6 M2 Competition 19-20, M3 15-18, M4 15-20

Head Gasket

MLS Head Gasket

Bore	Thickness	Pkg Qty	Part No.	Retail
85mm	.044"	1	C14133-044	\$215.84

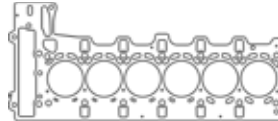

Additional thicknesses available
see pages 2 - 4

B58B30M0 Gen 1 3.0L Inline 6 340i 16-18, 16-19 440i, 540i 17-19, 640i 16-18, M240i 17-20, X3 18-19

Head Gasket

MLX Head Gasket

Bore	Thickness	Pkg Qty	Part No.	Retail
83mm	.036"	1	C14121-036	\$201.10

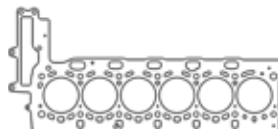

Additional thicknesses available
see pages 2 - 4



BMW

B58TU Gen 2 3.0L Inline 6 2019/20+ M40i/240i/340i/440i/540i/740i

NEW!

Head Gasket

MLX Head Gasket

Bore	Thickness	Pkg Qty	Part No.	Retail
83mm	.036"	1	C14144-036	\$201.10

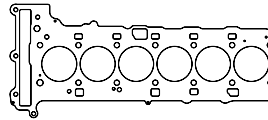

Additional thicknesses available see pages 2 - 4

S58B30T0 3.0L Inline 6 X3/X4 2019+, M3/M4 2021+

Head Gaskets

MLX Head Gasket

Bore	Thickness	Pkg Qty	Part No.	Retail
85mm	.036"	1	C15696-036	\$201.10

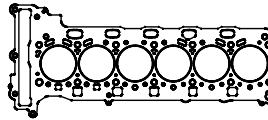

Additional thicknesses available see pages 2 - 4

NEW!

DST Head Gasket

Bore	Thickness	Pkg Qty	Part No.	Retail
85mm	.063"	1	C14207-063	302.17
85mm	.071"	1	C14207-071	302.17

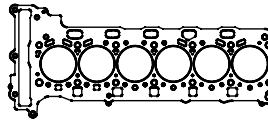

M30B34/M30B35 3.4L Inline 6, 5 Series 1985-88, 6 Series 1985-87, 7 Series 1985-87

Head Gasket

MLS Head Gasket

Bore	Thickness	Pkg Qty	Part No.	Retail
93mm	.070"	1	C4477-070	\$224.22

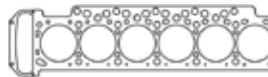

Additional thicknesses available see pages 2 - 4

S38B35/S38B36 3.5L Inline 6 M5 1984-92, M5i 1984-92, M6 1984-92

Head Gasket

MLS Head Gasket

Bore	Thickness	Pkg Qty	Part No.	Retail
95mm	.070"	1	C4478-070	\$224.22



Additional thicknesses available see pages 2 - 4

S65B40 4.0L V8 M3 (E90, E92, E93) 2007+Up

Head Gaskets

MLS Head Gaskets

Bore	Thickness	Pkg Qty	Part No.	Retail
93mm	.027"	1	C5111-027	\$160.89
94mm	.027"	1	C5112-027	\$160.89

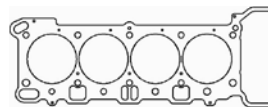

Additional thicknesses available see pages 2 - 4

N63B44/S63B44 Alpina B6/B7 11-18, 550i 11-17, 650i 12-18, 750i 09-18, M5 13-16, M6 12-18, X5 10-18, X6 08-18

Head Gasket

MLX Head Gasket

Bore	Thickness	Pkg Qty	Part No.	Retail
90mm	.032"	1	C15475-032	\$107.24
90mm	.040"	1	C15475-040	\$107.24

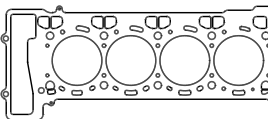

Additional thicknesses available see pages 2 - 4

S63B44T4 18-23 M5, 19-24 M8, 20-23 X5 M, 20-23 X6 M

NEW!

Head Gaskets

MLX Head Gasket

Bore	Thickness	Pkg Qty	Part No.	Retail
92mm	.032"	1	C14206-032	\$132.81
92mm	.044"	1	C14206-044	\$132.81

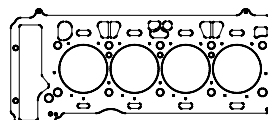

Additional thicknesses available see pages 2 - 4

BMW

N62B44 4.4L V8 X5 04, 745i 04, 745Ci 04, 545i 04, 645Ci 04

Head Gasket

MLS Head Gasket

Bore	Thickness	Pkg Qty	Part No.	Retail
94mm	.027"	1	C4374-027	\$168.92

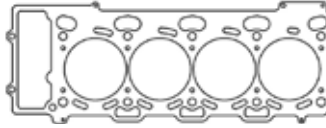

Additional thicknesses available
see pages 2 - 4

S85B50 5.0L V10 M5 2005-Up, M6 2005-Up

Head Gaskets

MLS Head Gaskets

Bore	Thickness	Pkg Qty	Part No.	Retail
93mm	.027"	1	C4528-027	\$160.89
94.5mm	.027"	1	C4529-027	\$160.89
94.5mm	.045"	1	C4529-045	\$160.89
94.5mm	.051"	1	C4529-051	\$160.89

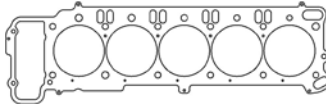

Additional thicknesses available
see pages 2 - 4

COVENTRY CLIMAX

FWA SOHC 1.1L 1098cc

Head Gasket

CFM-20 Head Gasket

Bore	Thickness	Pkg Qty	Part No.	Retail
74mm	.043"	1	C4301-043	\$97.84
74mm	.059"	1	C4301-059	\$97.84

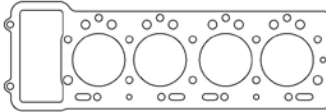

Additional thicknesses available
see pages 2 - 4

FWB/FWE SOHC 1.2L & 1.5L

Head Gasket

CFM-20 Head Gasket

Bore	Thickness	Pkg Qty	Part No.	Retail
78mm	.043"	1	C4139-043	\$97.84
78mm	.059"	1	C4139-059	\$97.84

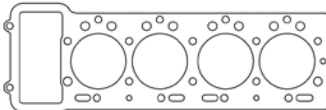

Additional thicknesses available
see pages 2 - 4

FWA/FWB/FWE SOHC 2.0L

Head Gasket

CFM-20 Head Gasket

Bore	Thickness	Pkg Qty	Part No.	Retail
80mm	.043"	1	C4229-043	\$97.84
80mm	.059"	1	C4229-059	\$97.84

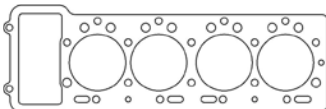

Additional thicknesses available
see pages 2 - 4

FPF DOHC 1.5L

Head Gasket

CFM-20 Head Gasket

Bore	Thickness	Pkg Qty	Part No.	Retail
82mm	.043"	1	C4267-043	\$107.31
82mm	.059"	1	C4267-059	\$107.31



Additional thicknesses available
see pages 2 - 4



FERRARI

308 V8 2v 1974-81

Head Gaskets

MLS Head Gaskets

Bore	Thickness	Pkg Qty	Part No.	Retail
81mm	.045"	1	C4430-045	\$168.92
89mm	.045"	1	C4395-045	\$168.92

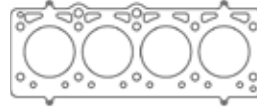

Additional thicknesses available
see pages 2 - 4

308 V8 4v 1982-84

Head Gaskets

MLS Head Gaskets

Bore	Thickness	Pkg Qty	Part No.	Retail
83mm	.045"	1	C4428-045	\$168.92
89mm	.045"	1	C4429-045	\$168.92

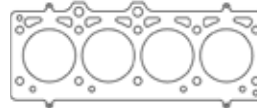

Additional thicknesses available
see pages 2 - 4

F40 2.9L Twin Turbo V8 1987-92

Head Gasket

MLS Head Gasket

Bore	Thickness	Pkg Qty	Part No.	Retail
84mm	.067"	1	C4482-067	\$204.44

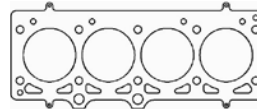

Additional thicknesses available
see pages 2 - 4

FIAT / LANCIA

138.A2 1.5L 1498cc 14 Bolt Head:1986-88 X1/9

Head Gasket

MLS Head Gasket

Bore	Thickness	Pkg Qty	Part No.	Retail
88mm	.044"	1	C4952-044	\$107.24

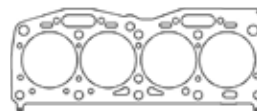

Additional thicknesses available
see pages 2 - 4

Lancia Delta

Head Gasket

MLS Head Gasket

Bore	Thickness	Pkg Qty	Part No.	Retail
85mm	.040"	1	C4124-040	\$107.24

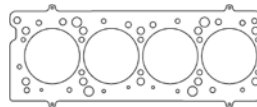

Additional thicknesses available
see pages 2 - 4

FORD / LOTUS

1.0L 2014-Up Fox EcoBoost

Head Gasket

MLX Head Gasket

Bore	Thickness	Pkg Qty	Part No.	Retail
73mm	.032"	1	C14140-032	\$110.88

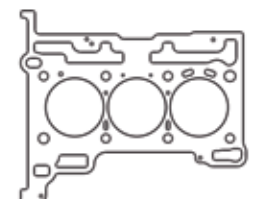

Additional thicknesses available
see pages 2 - 4

FORD / LOTUS

1.7L Zetec-S 1997-02 Puma

Head Gasket

Rubber Coated Stainless Head Gasket

Bore	Thickness	Pkg Qty	Part No.	Retail
83mm	.010"	1	C4223-010	\$67.01

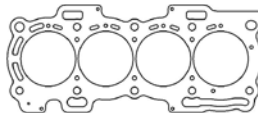

Additional thicknesses available
see pages 2 - 4

2.0L SOHC/DOHC NEP/YB Group A

Head Gasket

MLS Head Gasket

Bore	Thickness	Pkg Qty	Part No.	Retail
92.5mm	.040"	1	C4350-040	\$107.24

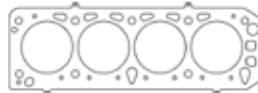

Additional thicknesses available
see pages 2 - 4

Individual Gaskets

Intake Gasket Set

Application	Part No.	Retail
Cosworth YB	C4502	\$50.03

Oil Pan Gasket

Application	Part No.	Retail
Cosworth YB Rails only	C4640	\$18.86

Exhaust Manifold Gasket Set

Application	Part No.	Retail
Cosworth YB	C4334	\$20.09

Front Cover Gasket

Application	Part No.	Retail
Cosworth YB	C4641	\$11.22

Valve Cover Gaskets

Application	Part No.	Retail
Early YB Engine - .060" AFM	C4635	\$33.83
Late YB Engine - .060" AFM	C4636	\$33.83

Cooling/Water Pump Gasket

Application	Part No.	Retail
Water Pump Gasket	C4637	\$6.39
Water Outlet Gasket	C4638	\$2.85
Thermostat Gasket	C4639	\$2.67

2.0L 2012-15 EcoBoost DOHC

Head Gasket

MLS Head Gasket

Bore	Thickness	Pkg Qty	Part No.	Retail
89mm	.034"	1	C15317-034	\$112.63
89mm	.066"	1	C15317-066	\$156.31

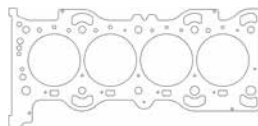

Additional thicknesses available
see pages 2 - 4

2.3L EcoBoost DOHC: 2016-2018 Ford Focus RS

Head Gasket

MLX Head Gasket

Bore	Thickness	Pkg Qty	Part No.	Retail
89mm	.040"	1	C15294-040	\$132.81

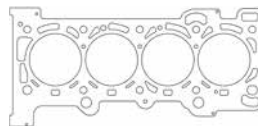

Additional thicknesses available
see pages 2 - 4

Individual Gaskets

Valve Cover Gasket

Application	Part No.	Retail
Valve Cover Gasket	C15445	\$42.55

Cosworth Ford 4cyl - FVA 1.6L/FVC 1.8L Gear Driven

Head Gaskets

MLS Head Gaskets

Bore	Thickness	Pkg Qty	Part No.	Retail
87mm	.040"	1	C4138-040	\$107.24
88mm	.040"	1	C4135-040	\$107.24

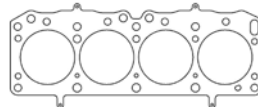

Additional thicknesses available
see pages 2 - 4

See page 94 for additional gaskets



FORD / LOTUS

Cosworth Ford 4cyl - FVA 1.6L/FVC 1.8L Gear Driven (continued)

Individual Gaskets

Valve Cover Gasket		
Application	Part No.	Retail
FVA/FVC .060" AFM	C4887	\$32.36

Exhaust Gasket Set		
Application	Part No.	Retail
FVA/FVC .064" AM (4 Pack)	C4888	\$19.09

Thermostat Housing Gasket		
Application	Part No.	Retail
FVA/FVC .060" AFM	C4889	\$1.49

Front Cylinder Head Cover Gasket		
Application	Part No.	Retail
FVA/FVC .060" AFM	C4890	\$5.57

Oil Pan Gasket		
Application	Part No.	Retail
FVA/FVC .060" AFM (Rails only)	C4891	\$18.86

Rear Cover Gasket		
Application	Part No.	Retail
FVA/FVC .060" AFM	C4892	\$4.23

Oil Pump Gasket		
Application	Part No.	Retail
FVA/FVC .060" AFM	C4893	\$2.85

Front Lower Cover Gasket		
Application	Part No.	Retail
FVA/FVC .012" Fiber	C4894	\$12.60

Cosworth Ford 4cyl 1.1-2.0L - BDA Series/Lotus Twin Cam, All Pushrod, Chain, & Belt Driven, Ford Kent Pre X-Flow, Ford Kent X-Flow, Ford Lotus Twin Cam 8V, Ford Cosworth BDA 16V

Head Gaskets

MLS Head Gaskets				
Bore	Thickness	Pkg Qty	Part No.	Retail
82mm	.040"	1	C4102-040	\$107.24
83mm	.040"	1	C4103-040	\$107.24
84mm	.040"	1	C4140-040	\$107.24
85mm	.040"	1	C4133-040	\$107.24
86mm	.040"	1	C4142-040	\$107.24
87mm	.040"	1	C4143-040	\$107.24

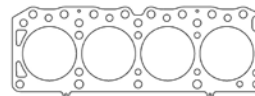

Additional thicknesses available
see pages 2 - 4

MLS Head Gaskets - BDG				
Bore	Thickness	Pkg Qty	Part No.	Retail
91mm	.040"	1	C4494-040	\$107.24

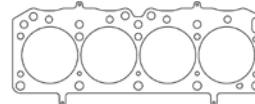

Individual Gaskets

Valve Cover Gaskets		
Application	Part No.	Retail
Lotus Twin Cam Chain Driven	C4895	\$28.14
BDA Belt Driven .060" AFM	C4896	\$22.07

Rear Cover Gasket		
Application	Part No.	Retail
BDA Series/Lotus Twin Cam .060" AFM	C4892	\$4.23

Intake Gasket Set		
Application	Part No.	Retail
BDA Series/Lotus Twin Cam	C4897	\$16.85

Thermostat Housing Gasket		
Application	Part No.	Retail
BDA Series/Lotus Twin Cam .060" AFM	C4889	\$1.49

Oil Pan Gasket		
Application	Part No.	Retail
BDA Series .060" AFM (Rails only)	C4891	\$18.86

Exhaust Gasket Sets		
Application	Part No.	Retail
Lotus Twin Cam 2 Bolt (4pk)	C4355-064	\$8.80
BDA 4 Bolt (4pk)	C4353-064	\$18.80
BDA 3 Bolt (4pk)	C4354-064	\$18.80

Oil Pump Gasket		
Application	Part No.	Retail
BDA Series/Lotus Twin Cam .060" AFM	C4893	\$2.85

Front Lower Cover Gasket		
Application	Part No.	Retail
BDA Series .012" Fiber	C4894	\$12.60

2.0L Zetec DOHC 4cyl 1995-04

Head Gasket

MLS Head Gasket				
Bore	Thickness	Pkg Qty	Part No.	Retail
87mm	.027"	1	C4279-027	\$102.61

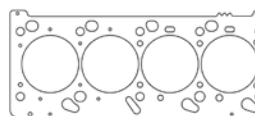

Additional thicknesses available
see pages 2 - 4

See page 95 for additional gaskets

FORD / LOTUS

2.0L Zetec DOHC 4cyl 1995-04 (continued)

Individual Gaskets

Valve Cover Gaskets		
Application	Part No.	Retail
2.0L Zetec DOHC 1995-97	C4643	\$34.31
2.0L Zetec DOHC 1998-04	C4644	\$64.10

Valve Stem Seals		
Application	Part No.	Retail
2.0L Zetec 1995-97 (16pk)	3181V-16	\$54.01
2.0L Zetec 1998-04 (16pk)	3182V-16	\$58.17

Exhaust Manifold Gasket Set		
Application	Part No.	Retail
2.0L Zetec 1994-04	C4645	\$21.15

Oil Pan Gasket		
Application	Part No.	Retail
2.0L Zetec 1995-04	C4649	\$31.99

Intake Gasket Set		
Application	Part No.	Retail
2.0L Zetec 1998-04	C4646	\$34.39
2.0L Zetec 1995-97	C4647	\$54.77

Thermostat Gaskets		
Application	Part No.	Retail
2.0L Zetec 1995-04 - Seal	C4651	\$2.24
2.0L Zetec 1995-04 - Housing	C4652	\$5.72

Cam Seal Set		
Application	Part No.	Retail
2.0L Zetec 1994-04	C4648	\$16.13

Rear Main Seal Set		
Application	Part No.	Retail
2.0L Zetec 1995-04	C4650	\$19.91

Gasket Kits



To purchase a complete gasket kit order both top end and bottom end gasket kit

TOP END GASKET KITS

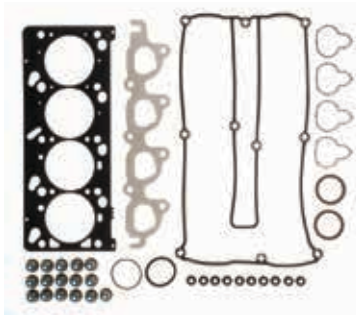

Application	Part No.	Retail
2.0L Zetec DOHC 1995-97 87mm Bore	PRO2029T	\$286.00
2.0L Zetec DOHC 1998-04 87mm Bore	PRO2030T	\$286.00

BOTTOM END GASKET KITS



Application	Part No.	Retail
2.0L Zetec DOHC 1995-97	PRO2029B	\$132.37
2.0L Zetec DOHC 1998-04	PRO2030B	\$132.37

2.3L "2300" SOHC 1974-97 4cyl

Head Gaskets

MLS Head Gaskets				
Bore	Thickness	Pkg Qty	Part No.	Retail
3.830"	.040"	1	C5369-040	\$84.41
3.940"	.040"	1	C5709-040	\$84.41

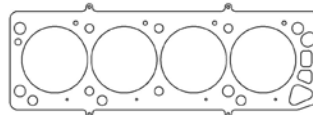

Additional thicknesses available
see pages 2 - 4

Individual Gaskets

Valve Cover Gasket		
Application	Part No.	Retail
2300 2.3L 1974-93	C4653	\$44.29

Oil Pan Gaskets		
Application	Part No.	Retail
2300 2.3L 1974-2/19/86	C5373	\$20.60
2300 2.3L 2/20/86-1990	C4669	\$57.11
2300 2.3L 1991-92	C4741	\$25.34
2300 2.3L 1993	C4778	\$25.34

Exhaust Manifold Gasket		
Application	Part No.	Retail
2300 2.3L 1974-93	C5372-064	\$18.28

Rear Main Seal Sets		
Application	Part No.	Retail
2300 2.3L 1974-81 2pc	C5688	\$34.21
2300 2.3L 1982-93 1pc	C5189	\$21.55

Intake Gasket		
Application	Part No.	Retail
2300 2.3L	C5371-060	\$15.50

See page 96 for additional gaskets

FORD / LOTUS

2.3L "2300" SOHC 1974-97 4cyl (continued)

Individual Gaskets (continued)

Valve Stem Seals		
Application	Part No.	Retail
2300 2.3L 1974-93 (need 8)	3168V	\$2.95

Water Pump Gasket		
Application	Part No.	Retail
2300 2.3L 1974-93	C4654	\$2.82

Gasket Kits



To purchase a complete gasket kit order both top end and bottom end gasket kit

TOP END GASKET KIT



Application	Part No.	Retail
2300 2.3L 1974-97 3.830" Bore	PRO2031T	\$238.32

BOTTOM END GASKET KIT

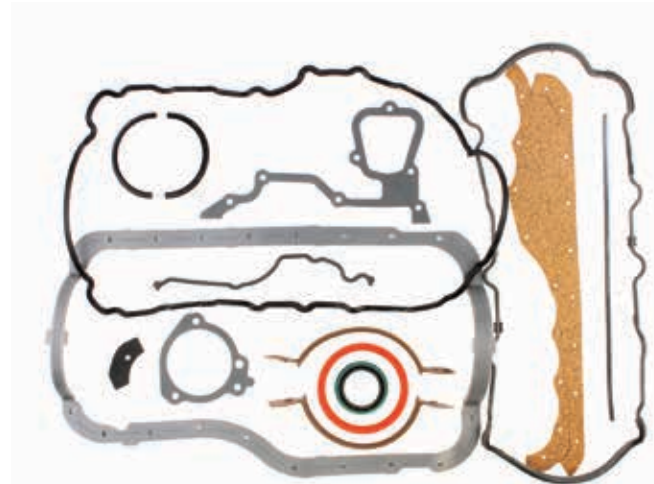

Application	Part No.	Retail
2300 2.3L 1974-97	PRO2031B	\$258.18

2.0L 2005-13 & 4.3L 2001-11 Duratec DOHC: 2003-2011 Focus, 2001-2011 Ranger

Head Gaskets

MLS Head Gaskets				
Bore	Thickness	Pkg Qty	Part No.	Retail
89.5mm	.018"	1	C5843-018	\$112.63
92mm	.018"	1	C5842-018	\$112.63

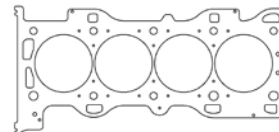

Additional thicknesses available see pages 2 - 4

Individual Gaskets

Intake Gasket		
Application	Part No.	Retail
2.3L Duratec 2003-08	C4842-060	\$21.00

Exhaust Manifold Gaskets		
Application	Part No.	Retail
2.3L Duratec (w/ extra port)	C4840-064	\$28.14
2.3L Duratec (w/o extra port)	C4841-064	\$28.14

3.0L Essex V6 1966-88

Head Gasket

MLS Head Gasket				
Bore	Thickness	Pkg Qty	Part No.	Retail
95mm	.040"	1	C4971-040	\$82.96



Additional thicknesses available see pages 2 - 4



FORD / LOTUS

4.0L Barra Inline 6 DOHC 2002-Present

Head Gaskets

MLS Head Gasket

Bore	Thickness	Pkg Qty	Part No.	Retail
93mm	.030"	1	C5957-030	\$191.52

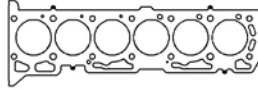

Additional thicknesses available
see pages 2 - 4

4.0L Intech Inline 6 1998-02

Head Gaskets

MLS Head Gasket

Bore	Thickness	Pkg Qty	Part No.	Retail
3.695"	.040"	1	C4597-040	\$191.52

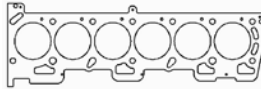

Additional thicknesses available
see pages 2 - 4

GM

ECOTEC 4 Cylinder

Head Gaskets

MLS Head Gasket - LSJ 2.0L

Bore	Thickness	Pkg Qty	Part No.	Retail
87mm	.027"	1	C5921-027	\$112.63

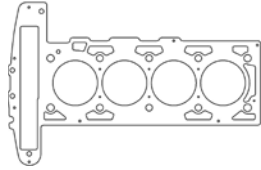

Additional thicknesses available
see pages 2 - 4

MLX Head Gasket - LSJ 2.0L

Bore	Thickness	Pkg Qty	Part No.	Retail
87mm	.040"	1	C5032-040	\$156.31

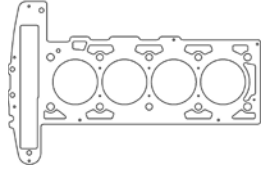

MLX Head Gaskets - LNF 2.0L 08-10

Bore	Thickness	Pkg Qty	Part No.	Retail
88mm	.032"	1	C15256-032	\$156.31

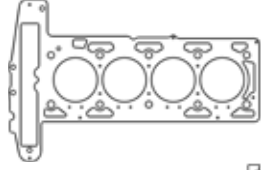

MLX Head Gasket - LTG 2.0L DOHC

Bore	Thickness	Pkg Qty	Part No.	Retail
87mm	.028"	1	C4964-028	\$156.31

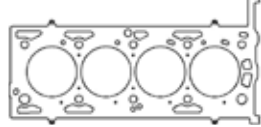

MLS Head Gaskets - L61/L42 2.2L DOHC

Bore	Thickness	Pkg Qty	Part No.	Retail
87mm	.040"	1	C5768-040	\$112.63
89mm	.040"	1	C5804-040	\$112.63

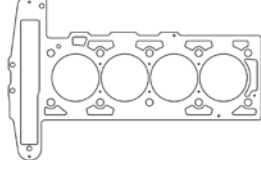

Individual Gaskets

MLS Exhaust Gasket

Application	Part No.	Retail
2000-2009 2.2/2.4L	C4150-030	\$27.22



GM

2.2L 134ci "L43/LN2": Cavalier/Sunfire FWD 1998-02, S-10/Sonoma RWD 1998-03

Head Gaskets

MLS Head Gaskets

Bore	Thickness	Pkg Qty	Part No.	Retail
90mm	.030"	1	C5914-030	\$112.63
93mm	.030"	1	C5915-030	\$112.63

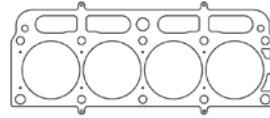

Additional thicknesses available
see pages 2 - 4

2.4L 146ci "LD9" Twin Cam 1996-2001

Head Gaskets

MLS Head Gasket - 1996-99 w/EGR

Bore	Thickness	Pkg Qty	Part No.	Retail
3.595"	.030"	1	C5298-030	\$107.27

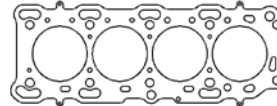

Additional thicknesses available
see pages 2 - 4

MLS Head Gaskets - 1999-01 w/o EGR

Bore	Thickness	Pkg Qty	Part No.	Retail
3.595"	.030"	1	C5866-030	\$107.27
3.595"	.075"	1	C5866-075	\$156.31

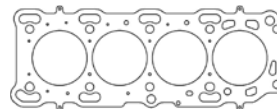

HOLDEN

Holden 253/304/308 V8

Head Gaskets

MLS Head Gasket

Bore	Thickness	Pkg Qty	Part No.	Retail
4.100"	.040"	1	C5806-040	\$109.94
4.200"	.040"	1	C5807-040	\$109.94
4.200"	.060"	1	C5807-060	\$156.98

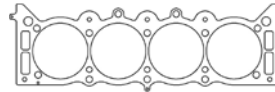

Additional thicknesses available
see pages 2 - 4

Individual Gaskets

Valve Cover Gasket (sold individually)

Application	Part No.	Retail
253/304/308 V8	C15458-188	\$29.28

Fuel Pump Gasket

Application	Part No.	Retail
253/304/308 V8	C15456-031	\$4.58

Intake Manifold Gaskets

Application	Part No.	Retail
253/304/308 V8	C15454-060	\$18.92

Exhaust Manifold Gaskets

Application	Part No.	Retail
253/304/308 V8	C15453-042	\$17.78

Timing Cover Set

Application	Part No.	Retail
253/304/308 V8	C15450-032	\$16.05

Water Pump Gasket

Application	Part No.	Retail
253/304/308 V8	C15451-032	\$16.05

Oil Pump Pickup Gasket

Application	Part No.	Retail
253/304/308 V8	C15452-032	\$2.29

Distributor Gasket

Application	Part No.	Retail
253/304/308 V8	C15457-031	\$4.58

HONDA / ACURA

L15B7, L15BA, L15BE 1.5L TURBO without VTEC: 2017-2020 Civic Si, 2016-2021 Civic, 2017-2020 CR-V

NEW!

Head Gaskets

MLS Head Gaskets

Bore	Thickness	Pkg Qty	Part No.	Retail
73.5mm	.024"	1	C14019-024	\$107.24
73.5mm	.031"	1	C14019-031	\$107.24
73.5mm	.036"	1	C14019-036	\$107.24
73.5mm	.040"	1	C14019-040	\$107.24

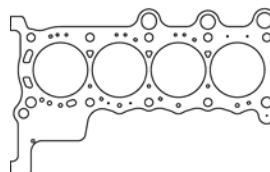

Additional thicknesses available
see pages 2 - 4

See page 99 for additional gaskets

HONDA / ACURA

L15B7, L15BA, L15BE 1.5L TURBO without VTEC: 2017-2020 Civic Si, 2016-2021 Civic, 2017-2020 CR-V (continued)

NEW!

Individual Gaskets

Valve Cover Gasket Set

Application	Part No.	Retail
L15B7	C14111	\$24.96

L15B7, L15BE, L15CA 1.5L TURBO with VTEC: 2022-2024 Civic, 2018-2023 Accord, 2023-2024 CR-V

NEW!

Head Gaskets

MLS Head Gasket

Bore	Thickness	Pkg Qty	Part No.	Retail
73.5mm	.024"	1	C14202-024	\$107.24
73.5mm	.031"	1	C14202-031	\$107.24
73.5mm	.036"	1	C14202-036	\$107.24
73.5mm	.040"	1	C14202-040	\$107.24

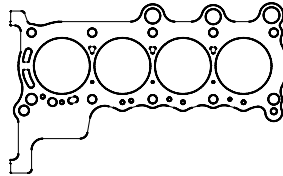

Additional thicknesses available see pages 2 - 4

NEW!

Individual Gaskets

Valve Cover Gasket

Application	Part No.	Retail
L15B7	C14111	\$24.96

D15B1/B2/B7/B8 1988-95, D16A6/A7 1988-91 SOHC

Head Gaskets

MLX Head Gasket

Bore	Thickness	Pkg Qty	Part No.	Retail
79mm	.032"	1	C14005-040	\$131.93
79mm	.040"	1	C14005-032	\$131.93

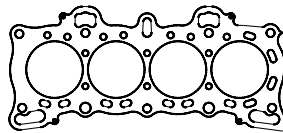

Additional thicknesses available see pages 2 - 4

MLS Head Gaskets

Bore	Thickness	Pkg Qty	Part No.	Retail
75.5mm	.030"	1	C4117-030	\$107.24
76mm	.030"	1	C4118-030	\$107.24
77mm	.030"	1	C4119-030	\$107.24
78mm	.030"	1	C4120-030	\$107.24
79mm	.030"	1	C4121-030	\$107.24

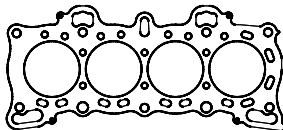

Individual Gaskets

Valve Cover Gasket Set

Application	Part No.	Retail
D15B1/B2/B7, D16A6/A7	C4701	\$38.44

Oil Pan Gasket

Application	Part No.	Retail
D15B1/B2/B7, D16A6/A7	C4660	\$42.00

Intake Gasket

Application	Part No.	Retail
D15B1/B2/B7, D16A6/A7	C4702-060	\$15.14

Rear Main Seal Set

Application	Part No.	Retail
D15B1/B2/B7, D16A6/A7	C4663	\$21.25

Exhaust Manifold Gasket

Application	Part No.	Retail
D15B1/B2/B7, D16A6/A7 - MLS	C4164-030	\$27.22

Front Crank/Oil Pump Seal

Application	Part No.	Retail
D15B1/B2/B7, D16A6/A7	C4664	\$5.18

Valve Stem Seals (sold individually)

Application	Part No.	Retail
D15B1/B2/B7, D16A6/A7	3170V	\$1.58

Timing Cover Dust Seal Sets

Application	Part No.	Retail
D15B1/B2/B7, D16A6/A7 - Lower	C4661	\$22.93
D15B1/B2/B7, D16A6/A8 - Upper	C4898	\$11.38

Cam Seal

Application	Part No.	Retail
D15B1/B2/B7, D16A6/A7	C4703	\$5.38

Water Pump Mounting O-ring

Application	Part No.	Retail
D15B1/B2/B7, D16A6/A7	C4700	\$4.56

Thermostat Seal Set

Application	Part No.	Retail
D15B1/B2/B7, D16A6/A7	C4704	\$9.95

See page 100 for StreetPro gasket kits



HONDA / ACURA

D15B1/B2/B7/B8 1988-95, D16A6/A7 1988-91 SOHC (continued)

Gasket Kits



To purchase a complete gasket kit order both top end and bottom end gasket kit

TOP END GASKET KITS



Application	Part No.	Retail
D15B1/B2/B7 88-95 76mm Bore	PRO2032T	\$246.28
D16A6/A7 88-91 76mm Bore	PRO2034T	\$211.84

BOTTOM END GASKET KIT



Application	Part No.	Retail
D15B1/B2/B7, D16A6/A7	PRO2032B	\$92.64

D16A1/A9 DOHC 1986-89

Head Gaskets

MLS Head Gaskets

Bore	Thickness	Pkg Qty	Part No.	Retail
75.5mm	.030"	1	C4522-030	\$107.24
76mm	.030"	1	C4524-030	\$107.24
77mm	.030"	1	C4525-030	\$107.24
78mm	.030"	1	C4526-030	\$107.24

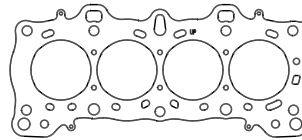

Additional thicknesses available see pages 2 - 4

Individual Gaskets

Valve Cover Gasket Set

Application	Part No.	Retail
D16A1/A9 1986-89	C4706	\$38.44

Oil Pan Gasket

Application	Part No.	Retail
D16A1/A9 1986-89	C4660	\$42.00

Intake Gasket

Application	Part No.	Retail
D16A1/A9 1986-89	C4707-046	\$8.82

Rear Main Seal Set

Application	Part No.	Retail
D16A1/A9 1986-89	C4663	\$21.25

Exhaust Manifold Gasket

Application	Part No.	Retail
D16A1/A9 1986-89	C4708	\$9.68

Front Crank/Oil Pump Seal

Application	Part No.	Retail
D16A1/A9 1986-89	C4664	\$5.18

Valve Stem Seals (sold individually)

Application	Part No.	Retail
D16A1/A9 1986-89	3177V	\$2.44

Water Pump Mounting O-ring

Application	Part No.	Retail
D16A1/A9 1986-89	C4700	\$4.56

Cam Seal

Application	Part No.	Retail
D16A1/A9 1986-89	C4709	\$19.52

Thermostat Seal

Application	Part No.	Retail
D16A1/A9 1986-89	C4710	\$6.29

See page 101 for StreetPro gasket kits

HONDA / ACURA

D16A1/A9 DOHC 1986-89 (continued)

Gasket Kits



To purchase a complete gasket kit order both top end and bottom end gasket kit

TOP END GASKET KIT



BOTTOM END GASKET KIT



Application	Part No.	Retail
D16A1/A9 1986-89 76mm	PRO2033T	\$211.84

Application	Part No.	Retail
D16A1/A9 1986-89	PRO2033B	\$79.40

D16Z6, D16Y5/Y7/Y8, D15Z1 1992-00 SOHC

Head Gaskets

MLS Head Gaskets

Bore	Thickness	Pkg Qty	Part No.	Retail
75.5mm	.030"	1	C4251-030	\$107.24
76mm	.030"	1	C4195-030	\$107.24
77mm	.030"	1	C4196-030	\$107.24
78mm	.030"	1	C4167-030	\$107.24
79mm	.030"	1	C4197-030	\$107.24

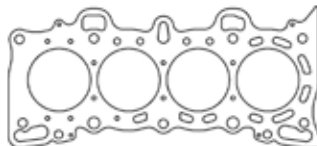

Additional thicknesses available
see pages 2 - 4

MLX Head Gaskets

Bore	Thickness	Pkg Qty	Part No.	Retail
79mm	.032"	1	C14134-032	\$131.93
79mm	.040"	1	C14134-040	\$131.93

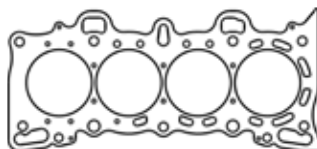

Individual Gaskets

Valve Cover Gasket Sets

Application	Part No.	Retail
D16Z6 1992-95	C4655	\$43.05
D16Y5/Y7/Y8 1996-00	C4665	\$27.46

Throttle Body Gaskets

Application	Part No.	Retail
D16Z6 1992-95	C4657-032	\$6.57
D16Y5/Y7/Y8 1996-00	C4667-032	\$6.57

Intake Gaskets

Application	Part No.	Retail
D16Z6 1992-95	C4702-060	\$15.14
D16Y5/Y7/Y8 1996-00	C4666	\$13.43

Oil Pan Gaskets

Application	Part No.	Retail
D16Z6 1992-95	C4660	\$42.00
D16Y5/Y8 1996-00	C4670	\$25.39
D16Y7 1996-00	C4899	\$25.39

Exhaust Manifold Gasket

Application	Part No.	Retail
D16Z6, D16Y5/Y7/Y8 - MLS	C4164-030	\$27.22

Rear Main Seal Set

Application	Part No.	Retail
D16Z6, D16Y5/Y7/Y8	C4663	\$21.25

See page 102 for additional gaskets



HONDA / ACURA

D16Z6, D16Y5/Y7/Y8, D15Z1 1992-00 SOHC (continued)

Individual Gaskets (continued)

Valve Stem Seals (sold individually)		
Application	Part No.	Retail
D16Z6, D16Y5/Y7/Y8	3170V	\$1.58

Front Crank/Oil Pump Seal		
Application	Part No.	Retail
D16Z6, D16Y5/Y7/Y8	C4664	\$5.18

Cam Seal		
Application	Part No.	Retail
D16Z6, D16Y5/Y7/Y8	C4658	\$11.41

Timing Cover Dust Seal Set		
Application	Part No.	Retail
D16Z6, D16Y5/Y7/Y8 - Lower	C4661	\$22.93

Thermostat Seal		
Application	Part No.	Retail
D16Z6, D16Y5/Y7/Y8	C4659	\$6.88

Water Pump Mounting O-ring		
Application	Part No.	Retail
D16Z6, D16Y5/Y7/Y8	C4662	\$5.72

Gasket Kits



To purchase a complete gasket kit order both top end and bottom end gasket kit

TOP END GASKET KITS



Application	Part No.	Retail
D16Z6 1992-95 76mm Bore	PRO2000T	\$205.67
D16Y5/Y7/Y8 1996-00 76mm Bore	PRO2001T	\$206.43

BOTTOM END GASKET KITS

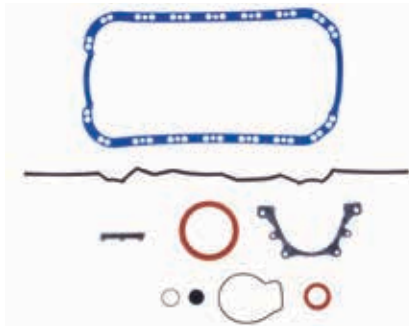

Application	Part No.	Retail
D16Z6 1992-95	PRO2000B	\$71.41
D16Y5/Y7/Y8 1996-00	PRO2001B	\$75.18

D17A1/D17A2/D17A6 1.7L SOHC 2001-05

Head Gaskets

MLS Head Gaskets				
Bore	Thickness	Pkg Qty	Part No.	Retail
76mm	.027"	1	C4474-027	\$107.24
77mm	.027"	1	C4473-027	\$107.24
78mm	.027"	1	C4472-027	\$107.24
79mm	.027"	1	C4471-027	\$107.24



Additional thicknesses available see pages 2 - 4

Individual Gaskets

Valve Stem Seals (sold individually)		
Application	Part No.	Retail
D17A1/A2/A6	3170V	\$1.58

Rear Main Seal		
Application	Part No.	Retail
D17A1/A2/A6	C4678	\$17.04

Cam Seal		
Application	Part No.	Retail
D17A1/A2/A6	C4658	\$11.41

Water Pump Mounting O-ring		
Application	Part No.	Retail
D17A1/A2/A6	C4662	\$5.72

HONDA / ACURA

B16A2/B16A3/B17A1/B18C1/B18C5 1.6/1.7/1.8L DOHC VTEC

Head Gaskets

MLX Head Gasket

Bore	Thickness	Pkg Qty	Part No.	Retail
85mm	.043"	1	C4999-043	\$131.93

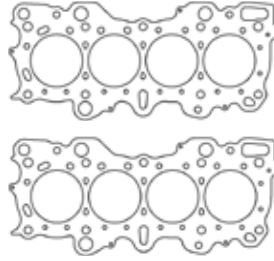

Additional thicknesses available
see pages 2 - 4

MLS Head Gaskets

Bore	Thickness	Pkg Qty	Part No.	Retail
81mm	.030"	1	C4231-030	\$107.24
81.5mm	.030"	1	C4232-030	\$107.24
82mm	.030"	1	C4168-030	\$107.24
83mm	.030"	1	C4189-030	\$107.24
84mm	.030"	1	C4188-030	\$107.24
85mm	.030"	1	C4182-030	\$107.24

Individual Gaskets

Valve Cover Gasket Set

Application	Part No.	Retail
B16A2/A3 & B18C1/C5	C4628	\$27.46

Thermostat Seal

Application	Part No.	Retail
B16A2/A3 & B18C1/C5	C4659	\$6.88

Intake Gaskets

Application	Part No.	Retail
B16A2/A3 & B18C5	C4671-060	\$11.46
B18C1	C4674	\$13.74

Throttle Body Gaskets

Application	Part No.	Retail
B16A3/B18C1 94-95	C4672-032	\$6.57
B16A2, B18C1/C5 96-01	C4656-032	\$6.57

Exhaust Manifold Gasket

Application	Part No.	Retail
B16A2/A3 & B18C1/C5 - MLS	C4151-030	\$22.26

Oil Pan Gasket

Application	Part No.	Retail
B16A2/A3 & B18C1/C5	C4676	\$23.73

Valve Stem Seals (sold individually)

Application	Part No.	Retail
B16A2/A3 & B18C1/C5	3170V	\$1.58

Rear Main Seal

Application	Part No.	Retail
B16A2/A3 & B18C1/C5	C4678	\$17.04

Cam Seal Set

Application	Part No.	Retail
B16A2/A3 & B18C1/C5	C4675	\$20.66

Water Pump Mounting O-ring

Application	Part No.	Retail
B16A2/A3 & B18C1/C5	C4677	\$2.98

Gasket Kits

To purchase a complete gasket kit order both top end and bottom end gasket kit

TOP END GASKET KITS

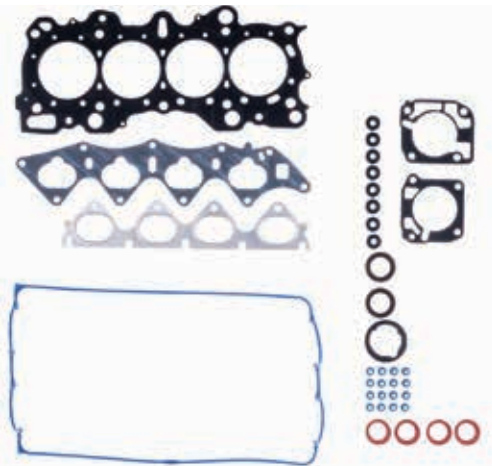

Application	Part No.	Retail
B16A2/A3, B18C5 82mm Bore	PRO2002T	\$238.32
B18C1 GS-R 82mm Bore	PRO2003T	\$264.81

BOTTOM END GASKET KIT



Application	Part No.	Retail
B16A2/A3, B18C1/C5	PRO2003B	\$75.30



HONDA / ACURA

B18A1/B18B1 1.8L DOHC non-VTEC 1990-01

Head Gaskets

MLS Head Gaskets

Bore	Thickness	Pkg Qty	Part No.	Retail
81mm	.030"	1	C4238-030	\$107.24
81.5mm	.030"	1	C4239-030	\$107.24
82mm	.030"	1	C4173-030	\$107.24
83mm	.030"	1	C4181-030	\$107.24
84mm	.030"	1	C4180-030	\$107.24
85mm	.030"	1	C4175-030	\$107.24

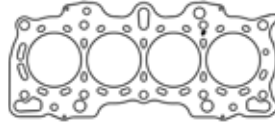

Additional thicknesses available
see pages 2 - 4

Individual Gaskets

Valve Cover Gasket Set

Application	Part No.	Retail
B18A1/B1	C4679	\$50.12

Intake Gasket

Application	Part No.	Retail
B18A1/B1 .094" KF	C4680-094	\$24.28

Exhaust Manifold Gasket

Application	Part No.	Retail
B18A1/B1 - .030" MLS	C4151-030	\$22.26

Valve Stem Seals (sold individually)

Application	Part No.	Retail
B18A1/B1	3177V	\$2.44

Cam Seal Set

Application	Part No.	Retail
B18A1/B1	C4709	\$19.52

Throttle Body Gasket

Application	Part No.	Retail
B18A1 1990-93	C4681	\$6.57
B18B1 1994-95 Manual, 1994-01 Auto Trans Only	C4672-032	\$6.57
B18B1 1996-01 Manual Trans Only	C4656-032	\$6.57

Thermostat Seal

Application	Part No.	Retail
B18A1/B1	C4659	\$6.88

Oil Pan Gasket Set

Application	Part No.	Retail
B18A1/B1	C4676	\$23.73

Rear Main Seal Set

Application	Part No.	Retail
B18A1/B1	C4678	\$17.04

Water Pump Mounting O-ring

Application	Part No.	Retail
B18A1/B1	C4677	\$2.98

Gasket Kits



To purchase a complete gasket kit order both top end and bottom end gasket kit

TOP END GASKET KIT

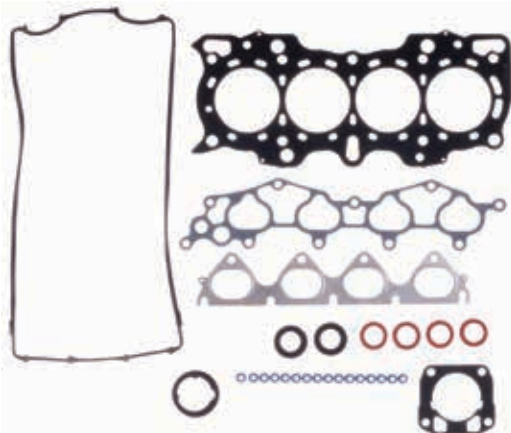

Application	Part No.	Retail
B18A1/B1 1990-01 82mm Bore	PRO2004T	\$233.03

BOTTOM END GASKET KIT



Application	Part No.	Retail
B18A1/B1 1990-01	PRO2004B	\$71.41

HONDA / ACURA

B Series Hybrid (VTEC Head/non-VTEC Block)

Head Gaskets

MLS Head Gaskets

Bore	Thickness	Pkg Qty	Part No.	Retail
81mm	.030"	1	C4237-030	\$107.24
81.5mm	.030"	1	C4236-030	\$107.24
82mm	.030"	1	C4191-030	\$107.24
83mm	.030"	1	C4192-030	\$107.24
84mm	.030"	1	C4193-030	\$107.24
84.5mm	.030"	1	C4241-030	\$107.24
85mm	.030"	1	C4194-030	\$107.24

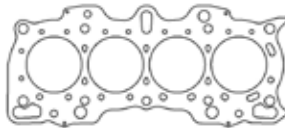

Additional thicknesses available
see pages 2 - 4

MLS Head Gaskets

Bore	Thickness	Pkg Qty	Part No.	Retail
85mm	.043"	1	C14000-043	\$131.93

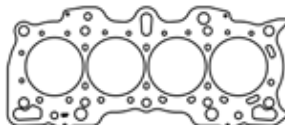

Individual Gaskets

Valve Cover Gasket Set

Application	Part No.	Retail
B16A2/A3 & B18C1/C5	C4628	\$27.46

Intake Gaskets

Application	Part No.	Retail
B16A2/A3 & B18C5	C4671-060	\$11.46
B18C1	C4674	\$13.74

Exhaust Manifold Gasket

Application	Part No.	Retail
B16A2/A3 & B18C1/C5 - MLS	C4151-030	\$22.26

Valve Stem Seals (sold individually)

Application	Part No.	Retail
B16A2/A3 & B18C1/C5	3170V	\$1.58

Cam Seal Set

Application	Part No.	Retail
B16A2/A3 & B18C1/C5	C4675	\$20.66

Thermostat Seal

Application	Part No.	Retail
B Series	C4659	\$6.88

Throttle Body Gaskets

Application	Part No.	Retail
B16A3/B18C1 94-95	C4672-032	\$6.57
B16A2, B18B1/C1/C5, B20Z2, F20C 96-01	C4656-032	\$6.57

Oil Pan Gasket Set

Application	Part No.	Retail
B Series	C4676	\$23.73

Rear Main Seal Set

Application	Part No.	Retail
B Series	C4678	\$17.04

Water Pump Mounting O-ring

Application	Part No.	Retail
B Series	C4677	\$2.98

Gasket Kits

To purchase a complete gasket kit order both top end and bottom end gasket kit

TOP END GASKET KITS

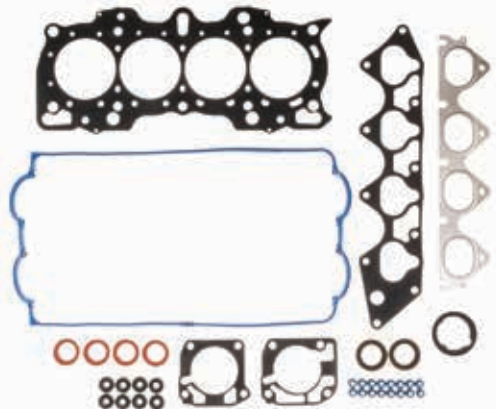

Application	Part No.	Retail
B20 w/B18C1 Head (GS-R) 84.5mm Bore	PRO2049T	\$264.81
B20 w/B16A2/A3/B18C5 Head 84.5mm Bore	PRO2050T	\$238.32

BOTTOM END GASKET KIT



Application	Part No.	Retail
B Series	PRO2004B	\$71.41



HONDA / ACURA

B20B4, B20Z2 2.0L DOHC non-VTEC 1997-01

Head Gasket

MLS Head Gasket				
Bore	Thickness	Pkg Qty	Part No.	Retail
85mm	.030"	1	C4250-030	\$107.24

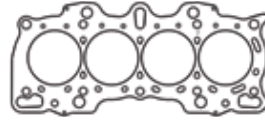

Additional thicknesses available
see pages 2 - 4

Individual Gaskets

Valve Cover Gasket Set			
Application	Part No.	Retail	
B20B4, B20Z2	C4679	\$50.12	

Thermostat Seal			
Application	Part No.	Retail	
B20B4, B20Z2	C4659	\$6.88	

Intake Gasket			
Application	Part No.	Retail	
B20B4, B20Z2 .094" KF	C4680-094	\$24.28	

Oil Pan Gasket Set			
Application	Part No.	Retail	
B20B4, B20Z2	C4676	\$23.73	

Exhaust Manifold Gasket			
Application	Part No.	Retail	
B20B4, B20Z2 - .030" MLS	C4151-030	\$22.26	

Rear Main Seal			
Application	Part No.	Retail	
B20B4, B20Z2	C4678	\$17.04	

Valve Stem Seals (sold individually)			
Application	Part No.	Retail	
B20B4, B20Z2	3177V	\$2.44	

Water Pump Mounting O-ring			
Application	Part No.	Retail	
B20B4, B20Z2	C4677	\$2.98	

Cam Seal Set			
Application	Part No.	Retail	
B20B4, B20Z2	C4709	\$19.52	

Throttle Body Gaskets			
Application	Part No.	Retail	
B20B4 With Auto Trans Only	C4657-032	\$6.57	
B20B4 With Manual Trans Only	C4667-032	\$6.57	
B20Z2 With Auto Trans Only	C4672-032	\$6.57	
B20Z2 With Manual Trans Only	C4656-032	\$6.57	

Gasket Kits



To purchase a complete gasket kit order both top end and bottom end gasket kit

TOP END GASKET KIT

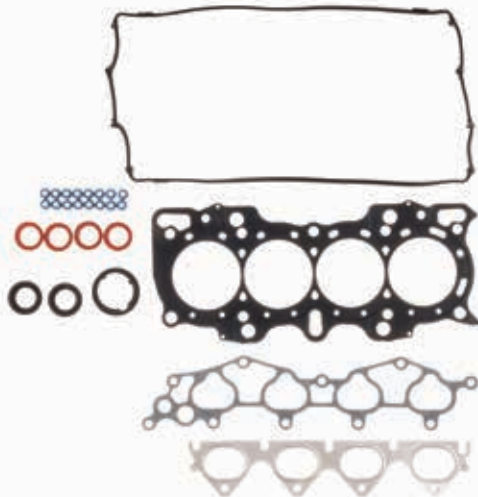

Application	Part No.	Retail
B20B4, B20Z2 84.5mm Bore	PRO2035T	\$225.08

BOTTOM END GASKET KIT

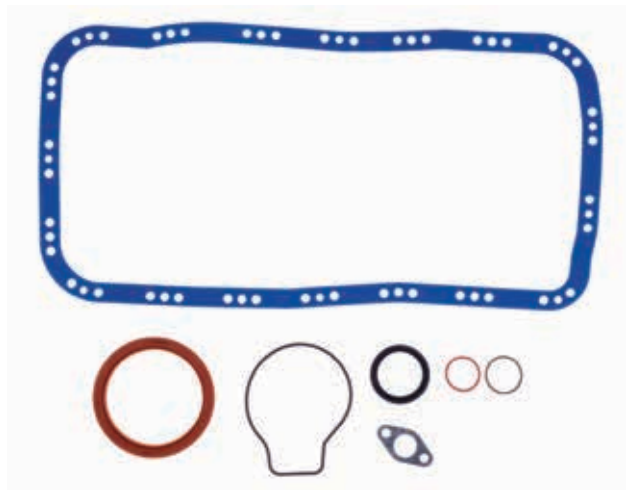

Application	Part No.	Retail
B Series	PRO2004B	\$71.41

HONDA / ACURA

B20A3/B20A5 2.0L 1988-91

Head Gaskets

MLS Head Gaskets

Bore	Thickness	Pkg Qty	Part No.	Retail
81.5mm	.045"	1	C4564-045	\$107.24
82mm	.045"	1	C4565-045	\$107.24
83mm	.045"	1	C4566-045	\$107.24
84mm	.045"	1	C4567-045	\$107.24

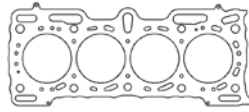

Additional thicknesses available
see pages 2 - 4

F20B 2.0L DOHC 1997-01

Head Gasket

MLS Head Gasket

Bore	Thickness	Pkg Qty	Part No.	Retail
86mm	.027"	1	C4634-027	\$107.24
86mm	.036"	1	C4634-036	\$107.24

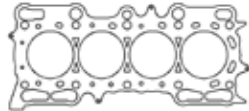

Additional thicknesses available
see pages 2 - 4

F20B/H22 Super Touring 1992-01, DOHC, Reverse-Head

Head Gasket

MLX Head Gasket

Bore	Thickness	Pkg Qty	Part No.	Retail
89.5mm	.032"	1	C14160-032	\$150.39

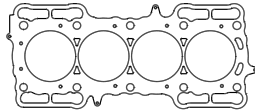

Additional thicknesses available
see pages 2 - 4

B21A1 2.1L 1990-91

Head Gaskets

MLS Head Gaskets

Bore	Thickness	Pkg Qty	Part No.	Retail
84mm	.040"	1	C4586-040	\$107.24
83mm	.045"	1	C4585-045	\$107.24
84mm	.045"	1	C4586-045	\$107.24

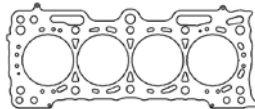

Additional thicknesses available
see pages 2 - 4

K20A2/K20A3/K20Z1/K24A1

Head Gaskets

MLS Head Gaskets

Bore	Thickness	Pkg Qty	Part No.	Retail
86mm	.030"	1	C4300-030	\$107.24
86.5mm	.030"	1	C14079-030	\$107.24
87mm	.030"	1	C4311-030	\$107.24
87mm	.040"	1	C4311-040	\$107.24
87.5mm	.030"	1	C14039-030	\$107.24
88mm	.030"	1	C4312-030	\$107.24
89mm	.030"	1	C4313-030	\$107.24
90mm	.040"	1	C14043-040	\$107.24

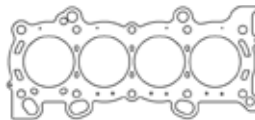

Additional thicknesses available
see pages 2 - 4

MLX Head Gaskets

Bore	Thickness	Pkg Qty	Part No.	Retail
89mm	.032"	1	C4596-032	\$150.39
89mm	.036"	1	C4596-036	\$150.39
89mm	.044"	1	C4596-044	\$150.39

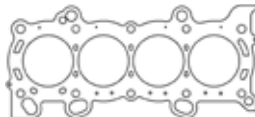

See page 108 for additional gaskets



HONDA / ACURA

K20A2/K20A3/K20Z1/K24A1 (continued)

Individual Gaskets

Exhaust Manifold Gaskets

Application	Part No.	Retail
K20A1/A3 2002-04 - MLS	C4160-030	\$27.22
K20A2 - MLS	C4162-030	\$27.22

Intake Gasket

Application	Part No.	Retail
K20A2/A3 2001+	C4668	\$18.91

Rear Main Seal

Application	Part No.	Retail
K-Series 2002+	C4705	\$39.17

Oil Pan Gasket

Application	Part No.	Retail
K20A1/A2/A3 2002-2013	C14011-060	\$28.67

K24A/K24A2/K24A3/K24A8/K24Z1 2004-2008 Acura TSX, 2006-2007 Honda Accord

Head Gaskets

MLS Head Gaskets

Bore	Thickness	Pkg Qty	Part No.	Retail
88mm	.030"	1	C14068-030	\$107.24

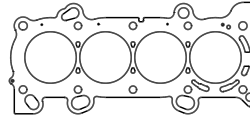

Additional thicknesses available
see pages 2 - 4

MLX Head Gaskets

Bore	Thickness	Pkg Qty	Part No.	Retail
89mm	.032"	1	C14071-032	\$150.39

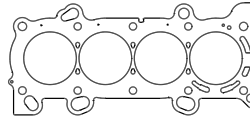

K20C1/K20C4 2015-Present Civic Type R; 2018-Present Honda Accord/Acura RDX

Head Gaskets

MLS Head Gaskets

Bore	Thickness	Pkg Qty	Part No.	Retail
87mm	.028"	1	C14014-028	\$107.24
88mm	.028"	1	C14021-028	\$107.24

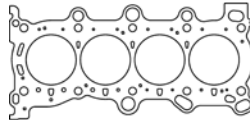

Additional thicknesses available
see pages 2 - 4

Individual Gaskets

Turbo/Exhaust Gasket Kit

Application	Part No.	Retail
K20C1 MLS	C14022-020	\$15.81

K20Z3 2.0L 2006-11

Head Gaskets

MLS Head Gaskets

Bore	Thickness	Pkg Qty	Part No.	Retail
86mm	.030"	1	C4561-030	\$107.24
87mm	.030"	1	C4562-030	\$107.24

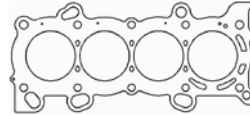

Additional thicknesses available
see pages 2 - 4

Individual Gaskets

Valve Cover Gasket

Application	Part No.	Retail
K-Series 2002+	C14012	\$16.96

Exhaust Manifold Gasket

Application	Part No.	Retail
K20 Exhaust - AM Material	C14007-064	\$18.33

Rear Main Seal

Application	Part No.	Retail
K-Series 2002+	C4705	\$39.17

Intake Gasket

Application	Part No.	Retail
K20Z3	C14095	\$11.46

Oil Pan Gasket

Application	Part No.	Retail
K20A1/A2/A3 2002-2013	C14011-060	\$28.67

Throttle Body Gaskets

Application	Part No.	Retail
2.0L K20Z3 Fiber	C14008-031	\$6.17

EGR Passage Gasket

Application	Part No.	Retail
2.0L K20Z3	C14132-010	\$12.68

See page 109 for StreetPro gasket kits

HONDA / ACURA

K20Z3 2.0L 2006-11 (continued)

Gasket Kits

STREETpro
by Cometic Gasket

To purchase a complete gasket kit order both top end and bottom end gasket kit

TOP END GASKET KIT



Application	Part No.	Retail
K20Z3 86mm Bore	PRO2054T	\$238.93

K24Y2/K24Z2/K24Z3/K24Z6/K24Z7 2.4L 2008-2015

Head Gaskets

MLS Head Gaskets

Bore	Thickness	Pkg Qty	Part No.	Retail
87mm	.030"	1	C4594-030	\$107.24
89mm	.030"	1	C4595-030	\$107.24
89mm	.036"	1	C4595-036	\$107.24

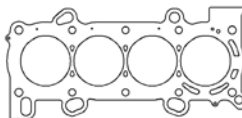

Additional thicknesses available
see pages 2 - 4

Individual Gaskets

Rear Main Seal

Application	Part No.	Retail
K-Series 2002+	C4705	\$39.17

Exhaust Manifold Gasket

Application	Part No.	Retail
K24Z2 / K24Z3 / K24Z6 / K24Z7	C14013-039	\$15.90

H22A1/H22A2 2.2L DOHC VTEC 1992-96

Head Gaskets

MLS Head Gaskets

Bore	Thickness	Pkg Qty	Part No.	Retail
87mm	.030"	1	C4255-030	\$107.24
88mm	.030"	1	C4198-030	\$107.24
89mm	0.03"	1	C4185-030	\$107.24

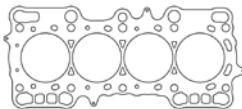

Additional thicknesses available
see pages 2 - 4

MLX Head Gaskets

Bore	Thickness	Pkg Qty	Part No.	Retail
89mm	.032"	1	C14015-032	\$120.39

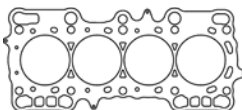

See page 110 for additional gaskets



HONDA / ACURA

H22A1/H22A2 2.2L DOHC VTEC 1992-96 (continued)

Individual Gaskets

Exhaust Manifold Gasket		
Application	Part No.	Retail
H22A1/H22A2 - MLS	C4155-030	\$33.43

Valve Stem Seals (sold individually)		
Application	Part No.	Retail
H22A1/H22A2	3170V	\$1.58

Thermostat Seal		
Application	Part No.	Retail
H22A1/H22A2	C4659	\$6.88

Cam Seal Set		
Application	Part No.	Retail
H22A1	C4675	\$20.66

Water Pump Gasket		
Application	Part No.	Retail
H22A1/H22A2	C4948	\$6.88

Oil Pan Gasket Set		
Application	Part No.	Retail
H22A1/H22A2	C4158	\$25.34

Rear Main Seal		
Application	Part No.	Retail
H22A1/H22A2	C4678	\$17.04

H22A4 1997-01, H22A7 1998-03 2.2L DOHC

Head Gaskets

MLS Head Gaskets				
Bore	Thickness	Pkg Qty	Part No.	Retail
87mm	.018"	1	C4252-018	\$107.24
87mm	.030"	1	C4252-030	\$107.24
88mm	.030"	1	C4253-030	\$107.24
89mm	.030"	1	C4254-030	\$107.24

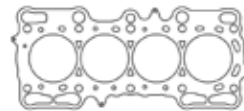

Additional thicknesses available
see pages 2 - 4

Individual Gaskets

Exhaust Manifold Gasket		
Application	Part No.	Retail
H22A4/H22A7 - MLS	C4155-030	\$33.43

Valve Stem Seals (sold individually)		
Application	Part No.	Retail
H22A4/H22A7	3170V	\$1.58

Thermostat Seal		
Application	Part No.	Retail
H22A4/H22A7	C4659	\$6.88

Cam Seal Set		
Application	Part No.	Retail
H22A4	C4675	\$20.66

Water Pump Gasket		
Application	Part No.	Retail
H22A4/H22A7	C4948	\$6.88

Oil Pan Gasket Set		
Application	Part No.	Retail
H22A4/H22A7	C4158	\$25.34

Rear Main Seal		
Application	Part No.	Retail
H22A4/H22A7	C4678	\$17.04

H23A1 2.3L DOHC VTEC 1992-96

Head Gaskets

MLS Head Gaskets				
Bore	Thickness	Pkg Qty	Part No.	Retail
87.5mm	.030"	1	C4553-030	\$107.24
88mm	.030"	1	C4554-030	\$107.24
89mm	.030"	1	C4555-030	\$107.24

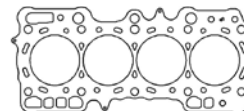

Additional thicknesses available
see pages 2 - 4

Individual Gaskets

Cam Seal Set		
Application	Part No.	Retail
H23A1	C4675	\$20.66

HONDA / ACURA

F22A1/ A4 / A6 (1990-93 Accord, 1992-96 Prelude SOHC 16V)

Head Gaskets

MLS Head Gaskets

Bore	Thickness	Pkg Qty	Part No.	Retail
85mm	.045"	1	C14017-045	\$107.24

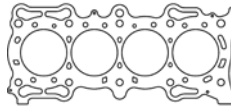

Additional thicknesses available
see pages 2 - 4

F22B1/B4/B5/B8 2.2L SOHC 1994-97, *F23A1 1998-02

Head Gaskets

MLS Head Gaskets

Bore	Thickness	Pkg Qty	Part No.	Retail
86mm	.027"	1	C4618-027	\$107.24
87mm	.027"	1	C4619-027*	\$107.24
88mm	.027"	1	C4620-027*	\$107.24
89mm	.027"	1	C4621-027*	\$107.24

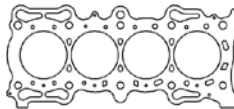

Additional thicknesses available
see pages 2 - 4

Individual Gaskets

Exhaust Manifold Gasket

Application	Part No.	Retail
F22B1/F23A1 1994-01 .064" AM	C4190-064	\$13.63

F20C1/C2, F22C1 2.0/2.2L DOHC VTEC 1999-09

Head Gaskets

MLS Head Gaskets

Bore	Thickness	Pkg Qty	Part No.	Retail
87.5mm	.030"	1	C4625-030	\$107.24
88mm	.030"	1	C4626-030	\$107.24
88.5mm	.030"	1	C4627-030	\$107.24
89mm	.030"	1	C4335-030	\$107.24

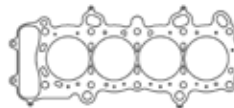

Additional thicknesses available
see pages 2 - 4

Individual Gaskets

Exhaust Manifold Gasket

Application	Part No.	Retail
F20C1/C2 99-09 - MLS	C4159-030	\$27.22

C30A1 DOHC 3.0L V6: Acura NSX 1991-1996 5 Speed Manual, 1991-2005 4 Speed Automatic

Head Gaskets

MLS Head Gaskets

Bore	Thickness	Pkg Qty	Part No.	Retail
91mm	.045"	1	C4550-045	\$120.63
93mm	.045"	1	C4551-045	\$120.63
95mm	.045"	1	C4277-045	\$120.63

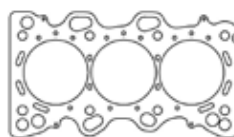

Additional thicknesses available
see pages 2 - 4

C32B1 DOHC 3.2L V6: Acura NSX 1997-2005 6 Speed Manual

Head Gasket

MLS Head Gasket

Bore	Thickness	Pkg Qty	Part No.	Retail
95mm	.030"	1	C4277-030	\$120.63

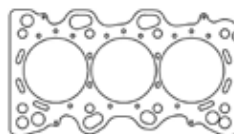

Additional thicknesses available
see pages 2 - 4

J32A1/J32A2/J35A1/J35A3/J35A 3.5L SOHC V6 01-04 Stock and Darton Sleeves

Head Gasket

MLS Head Gasket

Bore	Thickness	Pkg Qty	Part No.	Retail
90mm	.027"	1	C4382-027	\$97.84

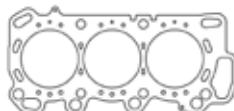

Additional thicknesses available
see pages 2 - 4



HONDA / ACURA

JNC1 3.5L DOHC V6 2017-Plus

Head Gaskets

HP Head Gasket - Right Side

Bore	Thickness	Pkg Qty	Part No.	Retail
90mm	.027"	1	C14137-027	\$112.35

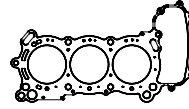

Additional thicknesses available
see pages 2 - 4

HP Head Gasket - Left Side

Bore	Thickness	Pkg Qty	Part No.	Retail
90mm	.027"	1	C14138-027	\$112.35

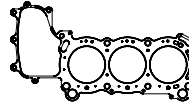

HYUNDAI

1.6L G4GJ Gamma II 4 Cylinder: 2013-15 Hyundai Veloster Turbo, 2014-16 Kia Forte

Head Gaskets

HP Head Gasket

Bore	Thickness	Pkg Qty	Part No.	Retail
78mm	.024"	1	C14174-024	\$156.31

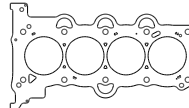

Additional thicknesses available
see pages 2 - 4

2.0L G4KF Theta II Turbo 4 Cylinder: 2010-14 Genesis Coupe

Head Gaskets

MLX Head Gasket

Bore	Thickness	Pkg Qty	Part No.	Retail
88mm	.032"	1	C4953-032	\$132.81

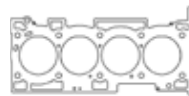

Additional thicknesses available
see pages 2 - 4

3.3L G6DP Lambda II RS T-GDi V6: 2018-23 Kia Stinger, 2019-23 Genesis G70, 2018-20 Genesis G80, 2017-2020 Genesis G90

Head Gaskets

MLX Head Gasket - Left Side

Bore	Thickness	Pkg Qty	Part No.	Retail
93.5mm	.032"	1	C14187-032	\$110.88

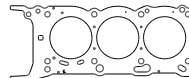

Additional thicknesses available
see pages 2 - 4

MLX Head Gasket - Right Side

Bore	Thickness	Pkg Qty	Part No.	Retail
93.5mm	.032"	1	C14186-032	\$110.88

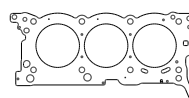

3.8L G6DA DOHC V6 Azera 2007-11, Entourage 2007-10, Genesis 2009-12, Veracruz 2007-11, Kia Sorento 2006-10, Kia Sorento 2007-09

Head Gaskets

MLX Head Gasket - Left Side

Bore	Thickness	Pkg Qty	Part No.	Retail
98mm	.032"	1	C4632-032	\$110.88

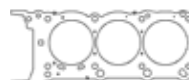

Additional thicknesses available
see pages 2 - 4

MLX Head Gasket - Right Side

Bore	Thickness	Pkg Qty	Part No.	Retail
98mm	.032"	1	C4633-032	\$110.88



JAGUAR

3.4L DOHC Inline 6: 48-53 XK120, 54-57 XK140, 57-61 XK150, 50-57 Mark VII, 56-58 Mark VIII, 57-59 Mark I, 59-67 Mark II, 67-68 340 Mark II, 63-68 S-Type

Head Gaskets

MLS Head Gaskets

Bore	Thickness	Pkg Qty	Part No.	Retail
83mm	.040"	1	C4281-040	\$187.77
85mm	.040"	1	C4303-040	\$187.77

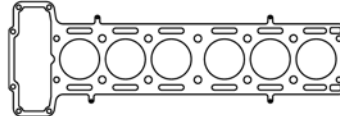

Additional thicknesses available
see pages 2 - 4

CFM-20 Head Gasket

Bore	Thickness	Pkg Qty	Part No.	Retail
83mm	.059"	1	C4302-059	\$147.55
85mm	.059"	1	C4304-059	\$147.55

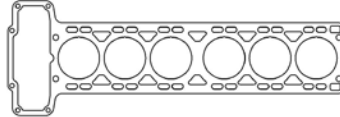

Individual Gaskets

Cam Cover Gasket Set

Application	Part No.	Retail
3.4/3.8/4.2L (Trim to Fit)	C4545-060	\$48.24

Oil Pan Gasket

Application	Part No.	Retail
3.4/3.8/4.2L .060" AFM	C4259-060	\$26.76

Intake Manifold Gaskets

Application	Part No.	Retail
3.8/4.2L Str Port Head	C4230-060	\$20.27
3.4/3.8L B Type Head	C4244-060	\$20.27

Engine Cover Gaskets

Application	Part No.	Retail
Front Main Seal Gasket	C4673-188	\$3.66
Rear Main Seal Gasket	C4901-188	\$3.66

Exhaust Manifold Gasket

Application	Part No.	Retail
3.4/3.8/4.2L	C4217-059	\$12.34

Timing Cover Gasket

Application	Part No.	Retail
3.4/3.8/E4.2L .018" AFM	C4336-018	\$21.82

Thermostat Gaskets

Application	Part No.	Retail
Series 1 1965-67	C4375-060	\$2.67
Series 2 1968-71	C4379-060	\$2.67

Engine Oil Gaskets

Application	Part No.	Retail
Oil Feed Gasket	C4949-032	\$2.67
Oil Filter Housing Gasket	C4179-032	\$4.02

Breather Cover Gasket Set

Application	Part No.	Retail
3.4/3.8/4.2L	C4544-060	\$8.05

Water Pump Gasket

Application	Part No.	Retail
3.4/3.8/E4.2L .018" AFM	C4337-018	\$6.87

3.8L DOHC Inline 6: 58-61 XK150 3.8, 58-61 XK150 3.8S, 58-61 Mark IX, 61-64 Mark X 3.8, 59-67 Mark II, 61-64 E-Type Series 1 3.8, 63-68 S-Type 3.8

Head Gaskets

MLS Head Gaskets

Bore	Thickness	Pkg Qty	Part No.	Retail
88mm	.040"	1	C4282-040	\$187.77
88.5mm	.050"	1	C14082-050	\$215.84
89mm	.040"	1	C4306-040	\$187.77

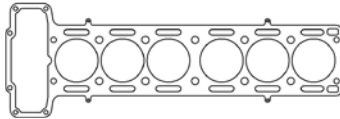

Additional thicknesses available
see pages 2 - 4

CFM-20 Head Gasket

Bore	Thickness	Pkg Qty	Part No.	Retail
87mm	.059"	1	C4305-059	\$147.55
88mm	.059"	1	C14041-059	\$147.55
89mm	.059"	1	C4125-059	\$147.55

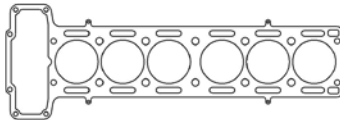

Individual Gaskets

Cam Cover Gasket Set

Application	Part No.	Retail
3.4/3.8/4.2L (Trim to Fit)	C4545-060	\$48.24

Oil Pan Gasket

Application	Part No.	Retail
3.4/3.8/4.2L .060" AFM	C4259-060	\$26.76

See page 114 for additional gaskets



JAGUAR

3.8L DOHC Inline 6: 58-61 XK150 3.8, 58-61 XK150 3.8S, 58-61 Mark IX, 61-64 Mark X 3.8, 59-67 Mark II, 61-64 E-Type Series 1 3.8, 63-68 S-Type 3.8 (continued)

Individual Gaskets (continued)

Intake Manifold Gaskets		
Application	Part No.	Retail
3.8/4.2L Str Port Head	C4230-060	\$20.27
3.4/3.8L B Type Head	C4244-060	\$20.27

Engine Cover Gaskets		
Application	Part No.	Retail
Front Main Seal Gasket	C4673-188	\$3.66
Rear Main Seal Gasket	C4901-188	\$3.66

Exhaust Manifold Gasket		
Application	Part No.	Retail
3.4/3.8/4.2L	C4217-059	\$12.34

Timing Cover Gasket		
Application	Part No.	Retail
3.4/3.8/E4.2L .018" AFM	C4336-018	\$21.82

Thermostat Gaskets		
Application	Part No.	Retail
Series 1 1965-67	C4375-060	\$2.67
Series 2 1968-71	C4379-060	\$2.67

Engine Oil Gaskets		
Application	Part No.	Retail
Oil Feed Gasket	C4949-032	\$2.67
Oil Filter Housing Gasket	C4179-032	\$4.02

Breather Cover Gasket Set		
Application	Part No.	Retail
3.4/3.8/4.2L	C4544-060	\$8.05

Water Pump Gasket		
Application	Part No.	Retail
3.4/3.8/E4.2L .018" AFM	C4337-018	\$6.87

4.0/4.2L AJ26/AJ26S/AJ27/AJ27S/AJ28/AJ33/AJ33S/AJ34/AJ34S V8 UK Engine

Head Gaskets

MLS Head Gasket - Left Side				
Bore	Thickness	Pkg Qty	Part No.	Retail
93mm	.030"	1	C4376-030	\$112.58

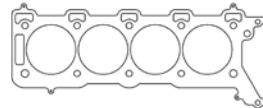

Additional thicknesses available
see pages 2 - 4

MLS Head Gasket - Right Side				
Bore	Thickness	Pkg Qty	Part No.	Retail
93mm	.030"	1	C4377-030	\$112.58

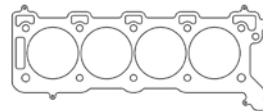

3.9L AJ30/AJ35 V8 US Engine

Head Gaskets

MLS Head Gaskets - Left Side				
Bore	Thickness	Pkg Qty	Part No.	Retail
87mm	.030"	1	C5772-030	\$115.44
93mm	.030"	1	C5773-030	\$115.44

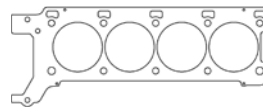

Additional thicknesses available
see pages 2 - 4

MLS Head Gaskets - Right Side				
Bore	Thickness	Pkg Qty	Part No.	Retail
87mm	.030"	1	C5770-030	\$115.44
93mm	.030"	1	C5771-030	\$115.44

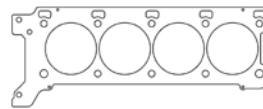

4.2L Inline 6: 65-67 Series 1, 64-66 Mark X 4.2, 66-68 420

Head Gaskets

MLS Head Gasket				
Bore	Thickness	Pkg Qty	Part No.	Retail
93mm	.040"	1	C14055-040	\$254.72

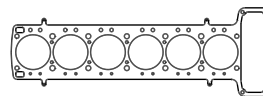

Additional thicknesses available
see pages 2 - 4

CFM-20 Head Gasket				
Bore	Thickness	Pkg Qty	Part No.	Retail
93mm	.059"	1	C4338-059	\$147.55

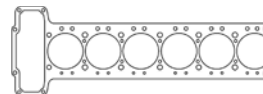

See page 115 for additional gaskets



JAGUAR

4.2L Inline 6: 65-67 Series 1, 64-66 Mark X 4.2, 66-68 420 (continued)

Individual Gaskets

Cam Cover Gasket Set		
Application	Part No.	Retail
3.4/3.8/4.2L (Trim to Fit)	C4545-060	\$48.24

Intake Manifold Gaskets		
Application	Part No.	Retail
3.8/4.2L Str Port Head	C4230-060	\$20.27
3.4/3.8L B Type Head	C4244-060	\$20.27

Exhaust Manifold Gasket		
Application	Part No.	Retail
3.4/3.8/4.2L	C4217-059	\$12.34

Thermostat Gaskets		
Application	Part No.	Retail
Series 1 1965-67	C4375-060	\$2.67
Series 2 1968-71	C4379-060	\$2.67

Breather Cover Gasket Set		
Application	Part No.	Retail
3.4/3.8/4.2L	C4544-060	\$8.05

Oil Pan Gasket		
Application	Part No.	Retail
3.4/3.8/4.2L .060" AFM	C4259-060	\$26.79

Main Seal Gasket		
Application	Part No.	Retail
Rear Main Seal Gasket	C4901-188	\$3.66

Timing Cover Gasket		
Application	Part No.	Retail
3.4/3.8/E4.2L .018" AFM	C4336-018	\$21.82

Engine Oil Gaskets		
Application	Part No.	Retail
Oil Feed Gasket	C4949-032	\$2.67
Oil Filter Housing Gasket	C4179-032	\$4.02

Water Pump Gasket		
Application	Part No.	Retail
3.4/3.8/E4.2L .018" AFM	C4337-018	\$6.87

4.2L Inline 6: 68-70 E-Type Series 2, 68-73 XJ6 4.2 Series 1

Head Gaskets

CFM-20 Head Gasket				
Bore	Thickness	Pkg Qty	Part No.	Retail
93mm	.059"	1	C4220-059	\$147.55

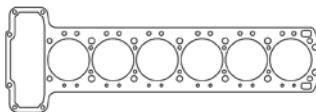

Additional thicknesses available
see pages 2 - 4

Individual Gaskets

Cam Cover Gasket Set		
Application	Part No.	Retail
3.4/3.8/4.2L (Trim to Fit)	C4545-060	\$48.24

Intake Manifold Gaskets		
Application	Part No.	Retail
3.8/4.2L Str Port Head	C4230-060	\$20.27
3.4/3.8L B Type Head	C4244-060	\$20.27

Exhaust Manifold Gasket		
Application	Part No.	Retail
3.4/3.8/4.2L	C4217-059	\$12.34

Thermostat Gaskets		
Application	Part No.	Retail
Series 1 1965-67	C4375-060	\$2.67
Series 2 1968-71	C4379-060	\$2.67

Breather Cover Gasket Set		
Application	Part No.	Retail
3.4/3.8/4.2L	C4544-060	\$8.05

Oil Pan Gasket		
Application	Part No.	Retail
3.4/3.8/4.2L .060" AFM	C4259-060	\$26.76

Seal Gasket		
Application	Part No.	Retail
Rear Main Seal Gasket	C4901-188	\$3.66

Timing Cover Gasket		
Application	Part No.	Retail
3.4/3.8/E4.2L .018" AFM	C4336-018	\$21.82
4.2L 1970+Up .018" AFM	C4902-018	\$21.82

Engine Oil Gaskets		
Application	Part No.	Retail
Oil Feed Gasket	C4949-032	\$2.67
Oil Filter Housing Gasket	C4179-032	\$4.02

Water Pump Gasket		
Application	Part No.	Retail
3.4/3.8/E4.2L .018" AFM	C4337-018	\$6.87
4.2L 1970+Up .018" AFM	C4903-018	\$5.38



JAGUAR

4.2L Hi-Performance Inline 6: 1973-87 XJ6 4.2 Series 3

Head Gaskets

MLS Head Gaskets

Bore	Thickness	Pkg Qty	Part No.	Retail
93mm	.040"	1	C4128-040	\$254.72
93.5mm	.040"	1	C4127-040	\$254.72

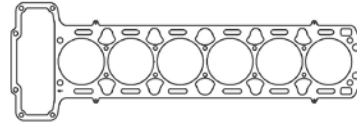

Additional thicknesses available
see pages 2 - 4

Individual Gaskets

Cam Cover Gasket Set

Application	Part No.	Retail
3.4/3.8/4.2L (Trim to Fit)	C4545-060	\$48.24

Oil Pan Gasket

Application	Part No.	Retail
3.4/3.8/4.2L .060" AFM	C4259-060	\$26.76

Intake Manifold Gaskets

Application	Part No.	Retail
3.8/4.2L Str Port Head	C4230-060	\$20.27
3.4/3.8L B Type Head	C4244-060	\$20.27

Main Seal Gasket

Application	Part No.	Retail
Rear Main Seal Gasket	C4901-188	\$3.66

Exhaust Manifold Gasket

Application	Part No.	Retail
3.4/3.8/4.2L	C4217-059	\$12.34

Timing Cover Gasket

Application	Part No.	Retail
4.2L 1970+Up .018" AFM	C4902-018	\$21.82

Thermostat Gaskets

Application	Part No.	Retail
Series 1 1965-67	C4375-060	\$2.67
Series 2 1968-71	C4379-060	\$2.67

Engine Oil Gaskets

Application	Part No.	Retail
Oil Feed Gasket	C4949-032	\$2.67
Oil Filter Housing Gasket	C4179-032	\$4.02

Breather Cover Gasket Set

Application	Part No.	Retail
3.4/3.8/4.2L	C4544-060	\$8.05

Water Pump Gasket

Application	Part No.	Retail
4.2L 1970+Up .018" AFM	C4903-018	\$5.38

5.0L V8 Jaguar AJ133/Land Rover LR-V8: 2009+Up XF, XJ, XK, XFR, XJR, XKR, 2011+Up XKR-S, 2013+Up XFR-S, F-Type Convertible, 2014+Up F-Type Coupe

Head Gaskets

MLX Head Gasket - Right Side

Bore	Thickness	Pkg Qty	Part No.	Retail
93mm	.040"	1	C15001-040	\$118.28

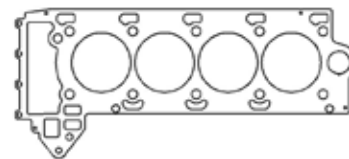

Additional thicknesses available
see pages 2 - 4

MLX Head Gasket - Left Side

Bore	Thickness	Pkg Qty	Part No.	Retail
93mm	.040"	1	C15000-040	\$118.28

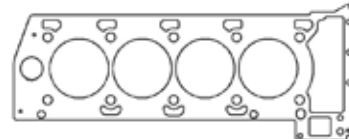

5.3L V12 1971-93

Head Gaskets

CFM-20 Head Gaskets - Left Side

Bore	Thickness	Pkg Qty	Part No.	Retail
93mm	.059"	1	C4330-059	\$147.55
97mm	.059"	1	C4221-059	\$147.55

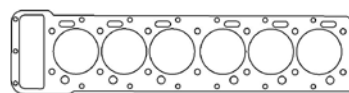

Additional thicknesses available
see pages 2 - 4

CFM-20 Head Gaskets - Right Side

Bore	Thickness	Pkg Qty	Part No.	Retail
93mm	.059"	1	C4331-059	\$147.55
97mm	.059"	1	C4222-059	\$147.55

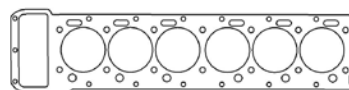

MAZDA

B6 1.6L DOHC 16V 1989-93 1597cc: 1990-1993 MX-5 Miata

Head Gaskets

MLS Head Gasket

Bore	Thickness	Pkg Qty	Part No.	Retail
80mm	.040"	1	C4122-040	\$120.63

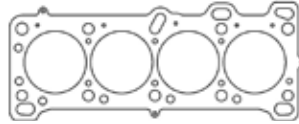

Additional thicknesses available
see pages 2 - 4

Individual Gaskets

Valve Cover Gasket Set

Application	Part No.	Retail
B6 1.6L 89-93	C4781	\$27.46

Rear Main Seal Set

Application	Part No.	Retail
B6 1.6L 89-93	C4783	\$14.63

Intake Manifold Gasket

Application	Part No.	Retail
B6 1.6L 89-93 .060" KF	C4779-060	\$13.69

Oil Pump Gasket Set

Application	Part No.	Retail
B6 1.6L 89-93	C4784	\$3.77

Exhaust Manifold Gasket

Application	Part No.	Retail
B6 1.6L 89-93 .030" MLS	C4165-030	\$37.10

Oil Pan Gasket Set

Application	Part No.	Retail
B6 1.6L 89-93 (Requires RTV)	C4785	\$12.15

Cam Seal Set

Application	Part No.	Retail
B6 1.6L 89-93 (2 Pack)	C4780	\$18.94

Water Pump Gasket

Application	Part No.	Retail
B6 1.6L 89-93	C4786	\$5.37

Valve Stem Seals (sold individually)

Application	Part No.	Retail
B6 1.6L 89-93	3169V	\$3.91

Thermostat Gasket

Application	Part No.	Retail
B6 1.6L 89-93 .046" Fiber	C4782-046	\$3.16

Gasket Kits



To purchase a complete gasket kit order both top end and bottom end gasket kit

TOP END GASKET KIT

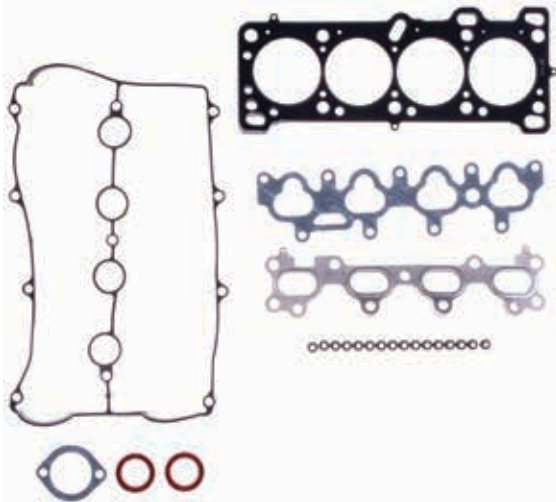

Application	Part No.	Retail
B6 1.6L 89-93 80mm Bore	PRO2036T	\$211.84

BOTTOM END GASKET KIT



Application	Part No.	Retail
B6 1.6L 89-93	PRO2036B	\$107.22



MAZDA

BP-ZE, BP-4W 1.8L DOHC 16V 1994-00 1839cc: 1994-1997, 1999-2000 MX-5 Miata

Head Gaskets

MLS Head Gaskets				
Bore	Thickness	Pkg Qty	Part No.	Retail
83mm	.040"	1	C4560-040	\$120.63
84mm	.040"	1	C4568-040	\$120.63
85mm	.040"	1	C4569-040	\$120.63

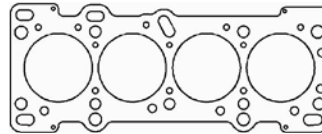

Additional thicknesses available
see pages 2 - 4

Individual Gaskets

Intake Manifold Gasket		
Application	Part No.	Retail
BP-ZE, BP-4W	C14030-018	\$14.43

Exhaust Manifold Gasket		
Application	Part No.	Retail
BP-ZE, BP-4W	C14033-060	\$16.85

BP-Z3, BP-4W Turbo 1.8L DOHC 16V 2001-05 1839cc, 01-03 Miata, 04-05 Miata Mazdaspeed

Head Gaskets

MLS Head Gaskets				
Bore	Thickness	Pkg Qty	Part No.	Retail
84mm	.040"	1	C4983-040	\$120.63
85mm	.040"	1	C4984-040	\$120.63

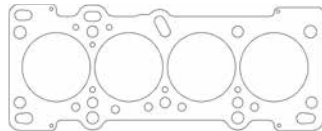

Additional thicknesses available
see pages 2 - 4

Individual Gaskets

Exhaust Manifold Gasket		
Application	Part No.	Retail
BP-Z3, BP-4W Turbo	C14033-060	\$16.85

FS-DE 2.0L DOHC 16V 1993-03 1991cc 93-97 MX-5, 1999-06 Kia Carens, 93-97 Protegé

Head Gaskets

MLS Head Gaskets				
Bore	Thickness	Pkg Qty	Part No.	Retail
84mm	.030"	1	C5844-030	\$126.63
84.5mm	.027"	1	C5845-027	\$126.63

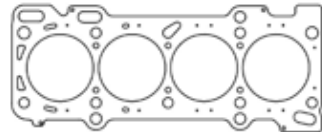

Additional thicknesses available
see pages 2 - 4

Individual Gaskets

Valve Cover Gasket Set		
Application	Part No.	Retail
FS-DE 2.0L DOHC	C4788	\$34.31

Oil Pan Gasket Set		
Application	Part No.	Retail
FS-DE 2.0L DOHC	C4790-062	\$16.54

Intake Manifold Gasket		
Application	Part No.	Retail
FS-DE 2.0L DOHC	C4787-046	\$11.99

Rear Main Seal Set		
Application	Part No.	Retail
FS-DE 2.0L DOHC	C4791	\$29.43

Exhaust Manifold Gasket		
Application	Part No.	Retail
FS-DE 2.0L DOHC .030" MLS	C4171-030	\$30.94

Water Pump Gasket		
Application	Part No.	Retail
FS-DE 2.0L DOHC	C4792-031	\$11.30

Cam Seal Set		
Application	Part No.	Retail
FS-DE 2.0L DOHC (2 Pack)	C4780	\$18.94

Thermostat Gasket Kit		
Application	Part No.	Retail
FS-DE 2.0L DOHC	C4789	\$10.57

Valve Stem Seals (sold individually)		
Application	Part No.	Retail
FS-DE 2.0L DOHC	3225V	\$2.04

See page 119 for StreetPro gasket kits

MAZDA

FS-DE 2.0L DOHC 16V 1993-03 1991cc 93-97 MX-5, 1999-06 Kia Carens, 93-97 Protegé (continued)

Gasket Kits

STREETpro
by Cometic Gasket

To purchase a complete gasket kit order both top end and bottom end gasket kit

TOP END GASKET KIT



BOTTOM END GASKET KIT

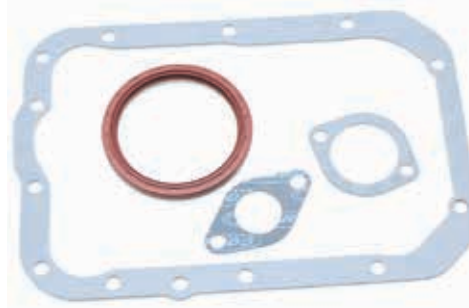

Application	Part No.	Retail
FS-DE 2.0L DOHC 93-03 84mm Bore	PRO2037T	\$198.59

Application	Part No.	Retail
FS-DE 2.0L DOHC 93-03	PRO2037B	\$48.95

MZR LF-DE 2.0L 2004-05 & L3-NS 2.3L 2001-09 DOHC: 2004-05 Mazda3, 2001-09 B2300

Head Gaskets

MLS Head Gaskets

Bore	Thickness	Pkg Qty	Part No.	Retail
89.5mm	.018"	1	C5843-018	\$112.63
92mm	.018"	1	C5842-018	\$112.63

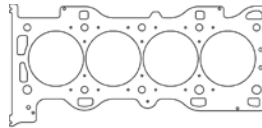

Additional thicknesses available
see pages 2 - 4

MZR L3-VDT 2.3L 2006-2013: 2007-2013 Mazda3 Mazdaspeed, 2006-2007 Mazda6 Mazdaspeed

Head Gasket

MLS Head Gasket

Bore	Thickness	Pkg Qty	Part No.	Retail
89mm	.030"	1	C4481-030	\$112.63

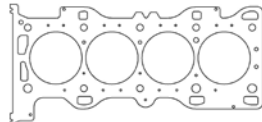

Additional thicknesses available
see pages 2 - 4

MLX Head Gasket

Bore	Thickness	Pkg Qty	Part No.	Retail
89mm	.028"	1	C4970-028	\$156.31

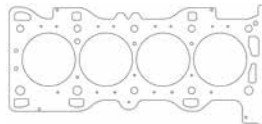

Individual Gaskets

Timing Cover Gasket

Application	Part No.	Retail
2006-08 MZR 2.3L	C14028	\$35.26

MZR LF-VE 2.0L 2006-15, L3-VE 2.3L 2006-2010, L5-VE 2.5L 2009-2015: 2006-2015 MX-5 Miata

Head Gasket

MLS Head Gasket

Bore	Thickness	Pkg Qty	Part No.	Retail
90mm	.040"	1	C5906-040	\$112.63

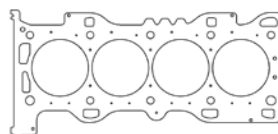

Additional thicknesses available
see pages 2 - 4



MAZDA

PE-VPS Skyactiv-G 2.0L DOHC, 2016-2020 MX-5 Miata

Head Gasket

MLS Head Gasket

Bore	Thickness	Pkg Qty	Part No.	Retail
85mm	.028"	1	C14161-028	\$107.24

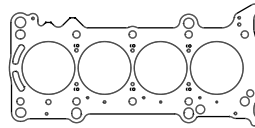

Additional thicknesses available
see pages 2 - 4

MERCEDES-BENZ

Mercedes-Benz 6.0L M120; 6.9/7.0L M297 V12: 1992-02 600SEC, 600SEL, 600SL, 1997 CLK-GTR

Head Gaskets

MLS Head Gasket - Left Side

Bore	Thickness	Pkg Qty	Part No.	Retail
90mm	.051"	1	C4501-051	\$383.44

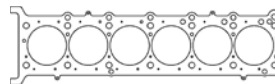

Additional thicknesses available
see pages 2 - 4

MLS Head Gasket - Right Side

Bore	Thickness	Pkg Qty	Part No.	Retail
90mm	.051"	1	C4500-051	\$383.44

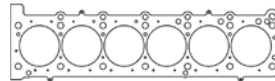

Mercedes-Benz 7.3L M120/M297 V12: 99-10 Pagani Zonda, 99-05 AMG SL73

Head Gaskets

MLS Head Gasket - Left Side

Bore	Thickness	Pkg Qty	Part No.	Retail
91.5mm	.051"	1	C4504-051	\$383.44

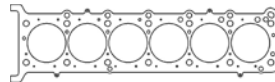

Additional thicknesses available
see pages 2 - 4

MLS Head Gasket - Right Side

Bore	Thickness	Pkg Qty	Part No.	Retail
91.5mm	.051"	1	C4503-051	\$383.44

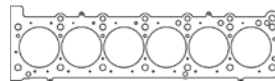

MG

Midget 1275cc Austin Series A

Head Gasket

MLS Head Gasket

Bore	Thickness	Pkg Qty	Part No.	Retail
74mm	.040"	1	C4148-040	\$107.24

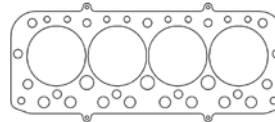

Additional thicknesses available
see pages 2 - 4

MGA1500 / 1600 / 1600 MKII Series B

Head Gasket

MLS Head Gasket

Bore	Thickness	Pkg Qty	Part No.	Retail
74mm	.040"	1	C4359-040	\$107.24

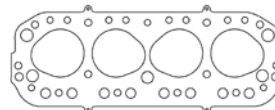

Additional thicknesses available
see pages 2 - 4

MGB 1.8L 18G / 18GA

Head Gasket

MLS Head Gasket

Bore	Thickness	Pkg Qty	Part No.	Retail
83mm	.040"	1	C4147-040	\$107.24

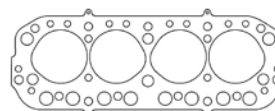

Additional thicknesses available
see pages 2 - 4

MINI

1.6L Tritec/Pentagon 1999-06

Head Gasket

MLS Head Gasket

Bore	Thickness	Pkg Qty	Part No.	Retail
78.5mm	.027"	1	C4308-027	\$107.24

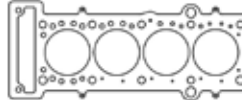

Additional thicknesses available
see pages 2 - 4

1.6L Turbo Prince / N14B16C / N14B16A / N18B16A / N18B16C 2007-13

Head Gasket

MLX Head Gasket

Bore	Thickness	Pkg Qty	Part No.	Retail
78mm	.032"	1	C4617-032	\$107.24
78mm	.036"	1	C4617-036	\$107.24
78mm	.040"	1	C4617-040	\$107.24

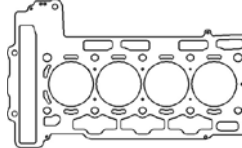

Additional thicknesses available
see pages 2 - 4

2.0L BMW / MINI 2015-19 B46A20A, B48A20A: 2014-19 Mini Cooper, 2017-21 BMW 230i, 2017-19 BMW 330i, 2017-2021 BMW 430i, 2017-2020 BMW 530i

Head Gasket

MLX Head Gasket

Bore	Thickness	Pkg Qty	Part No.	Retail
83.5mm	.032"	1	C14185-032	\$107.24

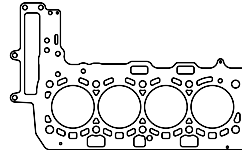

Additional thicknesses available
see pages 2 - 4

2.0L BMW / MINI 2020+ B46TU1

MLX Head Gasket

Bore	Thickness	Pkg Qty	Part No.	Retail
83.5mm	.032"	1	C14211-032	\$132.81

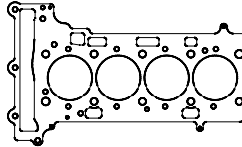

Additional thicknesses available
see pages 2 - 4

MITSUBISHI

2.0L 4G63/4G63-T DOHC: Eclipse 90-99, EVO 1-3 92-95

Head Gaskets

MLS Head Gaskets

Bore	Thickness	Pkg Qty	Part No.	Retail
85.5mm	.051"	1	C4233-051	\$107.24
86mm	.051"	1	C4234-051	\$107.24
87mm	.051"	1	C4235-051	\$107.24

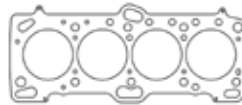

Additional thicknesses available
see pages 2 - 4

MLX Head Gasket

Bore	Thickness	Pkg Qty	Part No.	Retail
87mm	.050"	1	C4957-050	\$132.81

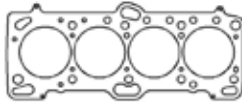

Individual Gaskets

Oil Pan Gaskets

Application	Part No.	Retail
4G63/T 89-92	C4695	\$16.47
4G63/T 93-94	C4698	\$24.26

Throttle Body Gaskets

Application	Part No.	Retail
4G63/T 91-94	C4693	\$6.57
4G63/T 95-97	C4904	\$6.57

See page 122 for additional gaskets



MITSUBISHI

2.0L 4G63/4G63-T DOHC: Eclipse 90-99, EVO 1-3 92-95 (continued)

Individual Gaskets (continued)

Valve Cover Gasket Set		
Application	Part No.	Retail
4G63/T 89-94	C4691	\$46.68

Intake Manifold Gasket		
Application	Part No.	Retail
4G63/T 89-94	C4692-060	\$18.28

Exhaust Manifold Gasket		
Application	Part No.	Retail
4G63/T 89-94 .030" MLS	C4199-030	\$27.22

Water Pump Gasket Set		
Application	Part No.	Retail
4G63/T 89-94	C4696	\$12.60

Valve Stem Seals (sold individually)		
Application	Part No.	Retail
4G63/T 89-94	3173V	\$2.43

Rear Main Seal Set		
Application	Part No.	Retail
4G63/T 89-92	C4697	\$28.18
4G63/T 93-94	C4699	\$22.05

Cam Seal Set		
Application	Part No.	Retail
4G63/T 89-94 (2 Pack)	C4905	\$25.26

Thermostat Gasket Set		
Application	Part No.	Retail
4G63/T 89-94	C4694	\$14.53

Gasket Kits



To purchase a complete gasket kit order both top end and bottom end gasket kit

TOP END GASKET KIT

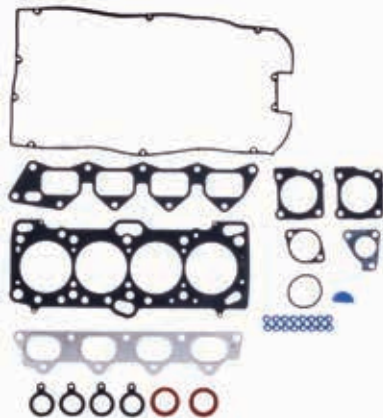

Application	Part No.	Retail
4G63/T 89-94 84mm Bore	PRO2006T	\$238.58

BOTTOM END GASKET KITS

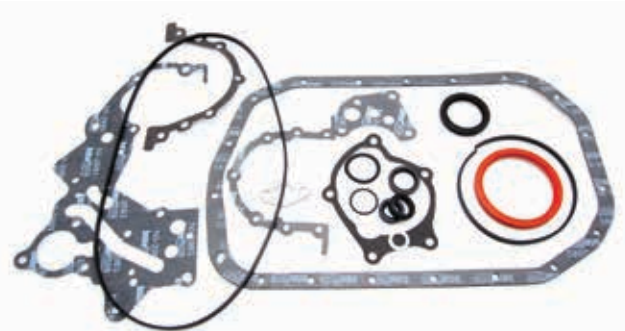

Application	Part No.	Retail
4G63/T 89-92	PRO2006B	\$99.28
4G63/T 93-94	PRO2007B	\$62.18

2.0L 4G63 / 4G63-T DOHC: EVO 4-8 1996-2005

Head Gaskets

MLS Head Gaskets				
Bore	Thickness	Pkg Qty	Part No.	Retail
85mm	.051"	1	C4157-051	\$107.24
86mm	.051"	1	C4156-051	\$107.24
87mm	.051"	1	C4591-051	\$107.24



Additional thicknesses available see pages 2 - 4

MLX Head Gasket				
Bore	Thickness	Pkg Qty	Part No.	Retail
87mm	.032"	1	C4956-032	\$110.88
87mm	.044"	1	C4956-044	\$132.81
87mm	.050"	1	C4956-050	\$132.81



Individual Gaskets

Exhaust Manifold Gasket		
Application	Part No.	Retail
96-06 Evolution	C4199-030	\$27.22

MITSUBISHI

2.0L 4G63/4G63-T DOHC: EVO 9 2006-2007

Head Gaskets

MLX Head Gasket

Bore	Thickness	Pkg Qty	Part No.	Retail
87mm	.032"	1	C14168-032	\$110.88

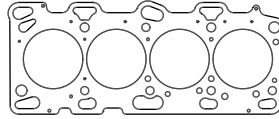

Additional thicknesses available
see pages 2 - 4

2.0L DOHC 4cyl ECC/420A 1995-99

Head Gaskets

MLS Head Gaskets

Bore	Thickness	Pkg Qty	Part No.	Retail
87.5mm	.040"	1	C5497-040	\$102.61
88.5mm	.040"	1	C5498-040	\$102.61

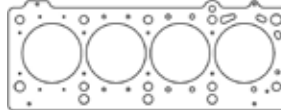

Additional thicknesses available
see pages 2 - 4

Individual Gaskets

Valve Cover Gasket Set

Application	Part No.	Retail
1995-99 2.0L DOHC	C15046	\$52.45

Intake Manifold Gaskets

Application	Part No.	Retail
Intake Manifold Gasket - .060" AFM	C15047-060	\$13.08
Intake Plenum Gasket - .031" Fiber	C15048-031	\$5.41

Exhaust Manifold Gasket

Application	Part No.	Retail
2.040" X 1.100" Port - MLS	C4161-030	\$27.22

Throttle Body Gasket

Application	Part No.	Retail
Molded Rubber	C15051	\$4.37

Valve Stem Seals Set (16 Pack)

Application	Part No.	Retail
5 x 10.8 x 18.3 x 16.9 - Hat Style	3180V-16	\$39.39

Cam Seal Set

Application	Part No.	Retail
Pair - 48 x 35 x 7	C15049	\$16.28

Front Crank Seal Set

Application	Part No.	Retail
1995-99 2.0L DOHC	C15053	\$24.96

Oil Pan Gasket

Application	Part No.	Retail
Molded Rubber	C15050	\$34.61

Rear Main Seal

Application	Part No.	Retail
1995-99 2.0L DOHC	C15052	\$15.93

Gasket Kits

To purchase a complete gasket kit order both top end and bottom end gasket kit

TOP END GASKET KIT

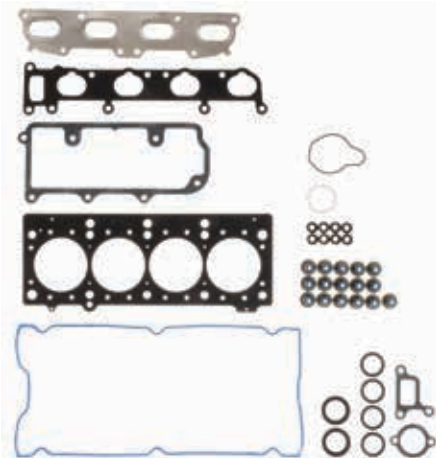

Application	Part No.	Retail
1995-99 420A 2.0L DOHC 88.5mm Bore	PRO2005T	\$185.35

BOTTOM END GASKET KIT



Application	Part No.	Retail
1995-99 420A 2.0L DOHC	PRO2005B	\$88.67



MITSUBISHI

2.0L 4B11T Turbo 2007+: EVO X 2007-15

Head Gaskets

MLX Head Gaskets

Bore	Thickness	Pkg Qty	Part No.	Retail
88mm	.044"	1	C4483-044	\$132.81
90mm	.044"	1	C4484-044	\$132.81

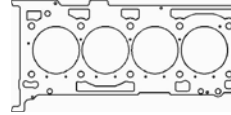

Additional thicknesses available
see pages 2 - 4

3.0L 6G72 SOHC/DOHC 24v V6 1988-00

Head Gaskets

MLS Head Gaskets

Bore	Thickness	Pkg Qty	Part No.	Retail
93mm	.051"	1	C4243-051	\$107.24
95mm	.051"	1	C4240-051	\$107.24

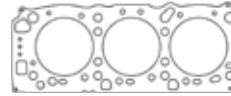

Additional thicknesses available
see pages 2 - 4

Individual Gaskets

Valve Cover Gasket Sets

Application	Part No.	Retail
1988-96 3.0L V6 SOHC	C4713	\$72.71
1991-00 3.0L V6 DOHC	C4722	\$95.57

Oil Pan Gaskets

Application	Part No.	Retail
1988-96 3.0L V6 SOHC	C4717	\$24.26
1991-00 3.0L V6 DOHC	C4727	\$24.26

Intake Manifold Gasket Sets

Application	Part No.	Retail
1988-96 3.0L V6 SOHC	C4714	\$31.35
1991-00 3.0L V6 DOHC	C4723	\$55.64

Water Pump Gasket Sets

Application	Part No.	Retail
1988-96 3.0L V6 SOHC	C4719	\$11.60
1991-00 3.0L V6 DOHC	C4728-020	\$5.46

Exhaust Manifold Gasket Sets

Application	Part No.	Retail
1988-96 3.0L V6 SOHC	C4715-042	\$58.94
1991-00 3.0L V6 DOHC	C4724-064	\$58.94

Rear Main Seal Set

Application	Part No.	Retail
1988-00 3.0L V6 SOHC/DOHC	C4720	\$16.74

Cam Seal Sets

Application	Part No.	Retail
1988-96 3.0L V6 SOHC (2)	C4905	\$25.26
1991-00 3.0L V6 DOHC (4)	C4725	\$22.03

Oil Pump Gasket Kits

Application	Part No.	Retail
1988-96 3.0L V6 SOHC	C4721	\$8.49
1991-00 3.0L V6 DOHC	C4729	\$9.23

Valve Stem Seals (sold individually)

Application	Part No.	Retail
1988-96 3.0L V6 SOHC	3157V	\$2.16
1991-00 3.0L V6 DOHC	3173V	\$2.43

Thermostat Gaskets

Application	Part No.	Retail
1988-96 3.0L V6 SOHC	C4716-032	\$8.03
1991-00 3.0L V6 DOHC	C4726	\$3.35

Gasket Kits



To purchase a complete gasket kit order both top end and bottom end gasket kit

TOP END GASKET KITS

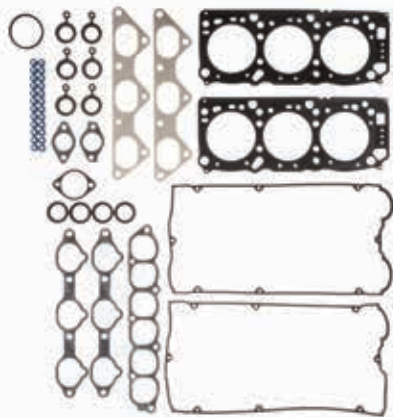

Application	Part No.	Retail
1988-96 3.0L V6 SOHC 93mm Bore	PRO2038T	\$345.60
1991-00 3.0L V6 DOHC 93mm Bore	PRO2039T	\$487.31

BOTTOM END GASKET KITS

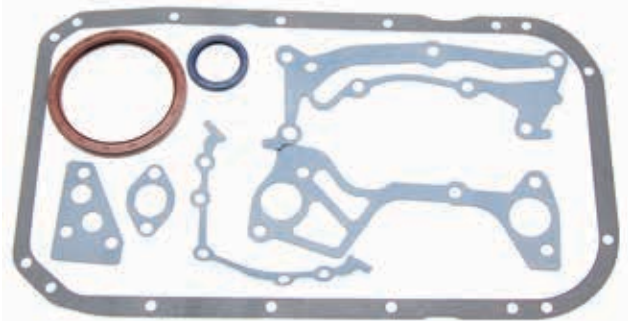

Application	Part No.	Retail
1988-96 3.0L V6 SOHC	PRO2038B	\$52.91
1991-00 3.0L V6 DOHC	PRO2039B	\$42.79

NISSAN

1.5L E15, E15S, E15T SOHC Pulsar 1980-86, Ninja Gayin 1984-94, Sunny 1980-86

Head Gasket

MLS Head Gasket				
Bore	Thickness	Pkg Qty	Part No.	Retail
77mm	.040"	1	C4178-040	\$107.24

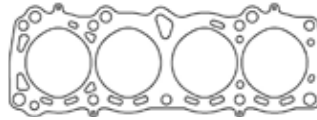

Additional thicknesses available
see pages 2 - 4

Individual Gaskets

Valve Cover Gasket Set		
Application	Part No.	Retail
E15T 1983-84	C4906	\$20.58

Cam Seal		
Application	Part No.	Retail
E15T 1983-84	C4910	\$5.31

Intake Manifold Gasket		
Application	Part No.	Retail
E15T 1983-84	C4907	\$12.44

Rear Main Seal Set		
Application	Part No.	Retail
E15T 1983-84	C4763	\$16.07

Exhaust Manifold Gaskets		
Application	Part No.	Retail
1982-83 E15S SOHC	C4908	\$15.17
1983-84 E15T SOHC	C4909	\$27.79

Front Crank Set		
Application	Part No.	Retail
E15T 1983-84	C4912	\$35.39

Valve Stem Seals (sold individually)		
Application	Part No.	Retail
E15T 1983-84	3159V	\$1.61

Water Pump Gasket Set		
Application	Part No.	Retail
E15T 1983-84	C4913	\$2.58

1.6L MR16DDT Juke 2011-2017, 2017-Present Sentra SR Turbo & NISMO

Head Gasket

MLS Head Gasket				
Bore	Thickness	Pkg Qty	Part No.	Retail
81mm	.032"	1	C4965-032	\$132.81

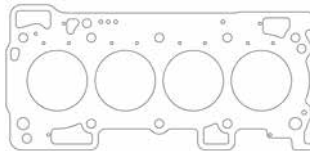

Additional thicknesses available
see pages 2 - 4

1.8L CA18 SOHC Skyline R31 1988-90, Skyline R32 GXi 1988-90, Skyline HR31 1985-91, Silvia Turbo 1984-89, 180SX 1981-83, 200SX 1984-88, Bluebird Turbo 1991-93, Bluebird 1983-85, 200SX Turbo 1984-87, Pulsar 1981-83, Sunny 1988-91

Head Gaskets

MLS Head Gasket				
Bore	Thickness	Pkg Qty	Part No.	Retail
85mm	.051"	1	C4479-051	\$124.30

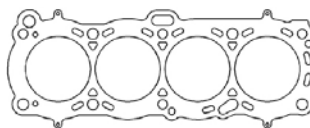

Additional thicknesses available
see pages 2 - 4



NISSAN

1.8L CA18 DOHC: Skyline HR31 1985-91, Silvia Turbo 1989-90, 180SX P/S13 1989-90, 200SX S13-U 1989-93, Bluebird Turbo 1987-89, Bluebird 1987-89, 200SX Turbo 1989-93, Pulsar, Sunny N13/B12 Coupe mid 80s

Head Gaskets

MLS Head Gasket				
Bore	Thickness	Pkg Qty	Part No.	Retail
85mm	.051"	1	C4480-051	\$124.30

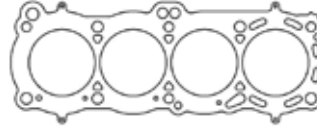

Additional thicknesses available see pages 2 - 4

Individual Gaskets

Valve Cover Gasket Set		
Application	Part No.	Retail
CA18DE/DET 1.8L	C4607	\$41.96

Throttle Body Gaskets		
Application	Part No.	Retail
CA18DE/DET 1.8L (pair)	C4740-032	\$6.81

Intake Gasket Set		
Application	Part No.	Retail
CA18DE/DET 1.8L	C4742	\$38.99

Rear Main Seal Set		
Application	Part No.	Retail
CA18DE/DET 1.8L	C4737	\$39.90

Exhaust Manifold Gasket Set		
Application	Part No.	Retail
CA18DE/DET 1.8L MLS 4pcs	C4523	\$38.43

Water Pump Gasket		
Application	Part No.	Retail
CA18DE/DET 1.8L	C4736-018	\$6.93

Cam Seal Set		
Application	Part No.	Retail
CA18DE/DET 1.8L (pair)	C4739	\$10.73

Oil Pump Gasket		
Application	Part No.	Retail
CA18DE/DET 1.8L	C4738-020	\$5.65

Valve Stem Seals (sold individually)		
Application	Part No.	Retail
CA18DE/DET 1.8L	3175V	\$1.71

Front Crank Seal		
Application	Part No.	Retail
CA18DE/DET 1.8L	C4914	\$5.38

Gasket Kits



To purchase a complete gasket kit order both top end and bottom end gasket kit

TOP END GASKET KIT

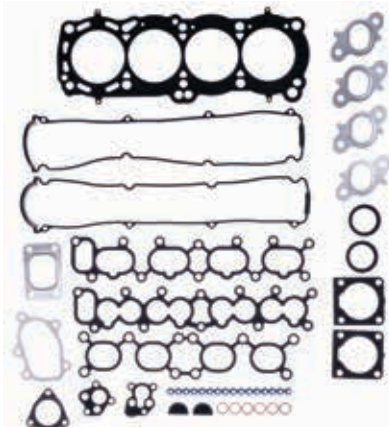

Application	Part No.	Retail
CA18DE/DET 1.8L 85mm Bore	PRO2018T	\$262.16

BOTTOM END GASKET KIT

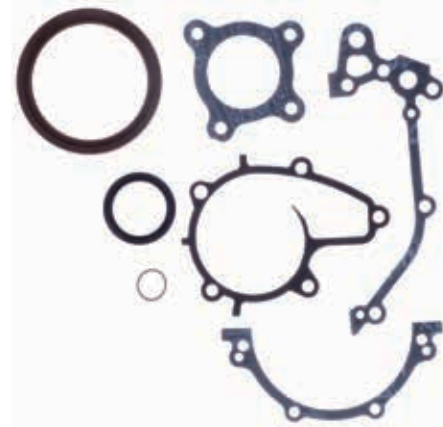

Application	Part No.	Retail
CA18DE/DET 1.8L	PRO2018B	\$58.20

NISSAN

2.0L FJ20E/ET 240RS 1983-85, Skyline DR30 1983-85, Silvia 1983-85

Head Gaskets

MLS Head Gaskets

Bore	Thickness	Pkg Qty	Part No.	Retail
90mm	.051"	1	C4326-051	\$120.63
91mm	.051"	1	C4327-051	\$120.63

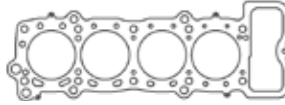

Additional thicknesses available
see pages 2 - 4

1.6L SR16VE/2.0L SR20VE DOHC 1997-01 Pulsar, Lucino, Primera, Bluebird, Wingroad, Sunny

Head Gasket

MLS Head Gaskets

Bore	Thickness	Pkg Qty	Part No.	Retail
87mm	.040"	1	C4600-040	\$107.24
88mm	.040"	1	C4601-040	\$107.24

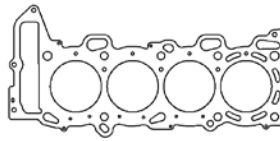

Additional thicknesses available
see pages 2 - 4

Individual Gaskets

Valve Cover Gasket Set

Application	Part No.	Retail
SR16VE/SR20VE	C4730	\$48.06

Throttle Body Gasket

Application	Part No.	Retail
SR16VE/SR20VE	C4733-018	\$3.40

Intake Gasket Set

Application	Part No.	Retail
SR16VE/SR20VE	C4731	\$38.96

Rear Main Seal

Application	Part No.	Retail
SR16VE/SR20VE	C4734	\$13.93

Exhaust Manifold Gasket Set

Application	Part No.	Retail
SR16VE/SR20VE	C4732-064	\$14.87
SR16VE/SR20VE MLS	C4995-030	\$33.48

Oil Pump Gasket

Application	Part No.	Retail
SR16VE/SR20VE	C4735-020	\$1.19

Valve Stem Seals (sold individually)

Application	Part No.	Retail
SR16VE/SR20VE	3175V	\$1.71

Front Crank Seal

Application	Part No.	Retail
SR16VE/SR20VE	C4915	\$6.43

Gasket Kits

To purchase a complete gasket kit order both top end and bottom end gasket kit

TOP END GASKET KIT

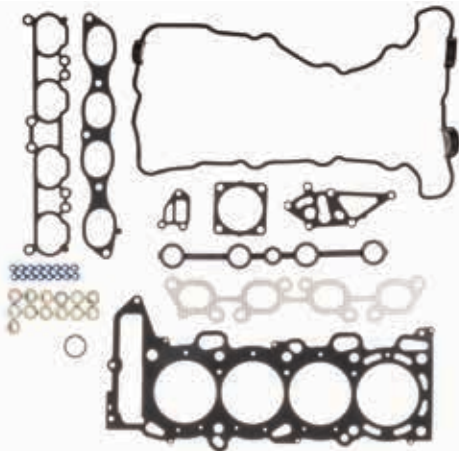

Application	Part No.	Retail
SR16VE/SR20VE 88mm Bore	PRO2053T	\$259.51

BOTTOM END GASKET KIT



Application	Part No.	Retail
SR16VE/SR20VE	PRO2053B	\$52.50



NISSAN

2.0L SR20DE/DET DOHC FWD: 91-92/94-97 180SX, 95-98 200SX SE-R, 96-98 Almera, 90/92-95/97-01 Avenir, 89/91-93/95-98 Bluebird, 98-00 Liberty, 91-02 Infinity G20, 91-93 NX2000, 91-00 Pulsar, 91-94/98-01 Sentra

Head Gaskets

MLS Head Gaskets				
Bore	Thickness	Pkg Qty	Part No.	Retail
87mm	.030"	1	C4575-030	\$107.24
88.5mm	.030"	1	C4130-030	\$107.24

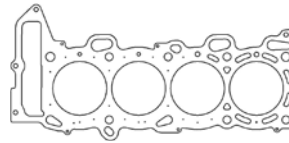

Additional thicknesses available
see pages 2 - 4

Individual Gaskets

Valve Cover Gasket Sets		
Application	Part No.	Retail
SR20DE/DET FWD 91-96	C4747	\$34.31
SR20DE/DET FWD 97-01	C4730	\$48.06

Intake Manifold Gaskets		
Application	Part No.	Retail
SR20DE/DET FWD 91-93	C4746	\$8.67
SR20DE/DET FWD 94-01	C4749	\$23.03

Thermostat Gasket Set		
Application	Part No.	Retail
SR20DE/DET FWD 91-01	C4916	\$7.13

Oil Pan Gasket		
Application	Part No.	Retail
SR20DE/DET FWD 91-01	C4744-156	\$26.71

Exhaust Manifold Gasket Set		
Application	Part No.	Retail
SR20DE/DET FWD 91-01 MLS	C4200-030	\$33.43

Water Pump Gasket		
Application	Part No.	Retail
SR20DE/DET FWD 91-01	C4745-031	\$3.68

Throttle Body Gasket		
Application	Part No.	Retail
SR20DE/DET FWD 91-01	C4733-018	\$3.40

Rear Main Seal Set		
Application	Part No.	Retail
SR20DE/DET FWD 91-01	C4743	\$38.85

Valve Stem Seals (sold individually)		
Application	Part No.	Retail
SR20DE/DET FWD 91-01	3175V	\$1.71

Front Crank Seal		
Application	Part No.	Retail
SR20DE/DET FWD 91-01	C4915	\$6.43

Gasket Kits



To purchase a complete gasket kit order both top end and bottom end gasket kit

TOP END GASKET KITS

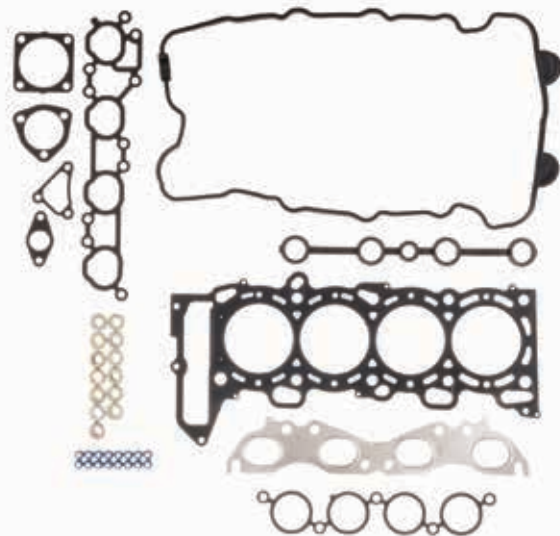

Application	Part No.	Retail
SR20DE/DET FWD 91-96 87mm Bore	PRO2012T	\$225.08
SR20DE/DET FWD 97-01 87mm Bore	PRO2011T	\$225.08

BOTTOM END GASKET KIT

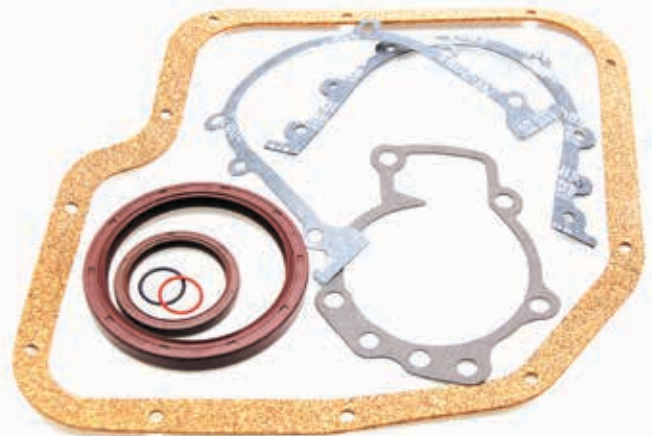

Application	Part No.	Retail
SR20DE/DET FWD 91-01	PRO2012B	\$62.18

2.0L SR20DE/DET DOHC S13 1989-93

Head Gasket

MLS Head Gasket				
Bore	Thickness	Pkg Qty	Part No.	Retail
87.5mm	.045"	1	C4324-045	\$107.24

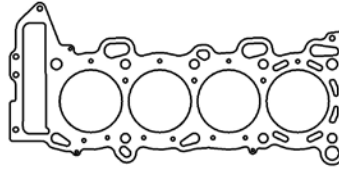

Additional thicknesses available
see pages 2 - 4

Individual Gaskets

Valve Cover Gasket Set		
Application	Part No.	Retail
SR20DE/DET S13 89-93	C4753	\$25.98

Throttle Body Gasket		
Application	Part No.	Retail
SR20DE/DET S13 89-93	C4733-018	\$3.40

Intake Manifold Gasket Set		
Application	Part No.	Retail
SR20DE/DET S13 89-93	C4752	\$15.09

Thermostat Gasket Set		
Application	Part No.	Retail
SR20DE/DET S13 89-93	C4758	\$4.65

Exhaust Manifold Gasket Set		
Application	Part No.	Retail
SR20DE/DET S13 89-93 MLS	C4200-030	\$33.43

Rear Main Seal Set		
Application	Part No.	Retail
SR20DE/DET S13 89-93	C4743	\$38.85

Valve Stem Seals (sold individually)		
Application	Part No.	Retail
SR20DE/DET S13 - EXH	3158V	\$1.61
SR20DE/DET S13 - INT	3175V	\$1.71

Front Crank Seal		
Application	Part No.	Retail
SR20DE/DET S13 89-93	C4915	\$6.43

Gasket Kits

To purchase a complete gasket kit order both top end and bottom end gasket kit

TOP END GASKET KITS



Application	Part No.	Retail
SR20DE/DET S13 w/o VC Set 87.5mm Bore	PRO2008T	\$225.08
SR20DE/DET S13 89-93 88mm Bore	PRO2052T	\$259.51

BOTTOM END GASKET KIT



Application	Part No.	Retail
SR20DE/DET S13 89-93	PRO2010B	\$62.18



NISSAN

2.0L SR20DE/DET DOHC S14/S15 1994-02

Head Gaskets

MLS Head Gaskets

Bore	Thickness	Pkg Qty	Part No.	Retail
86mm	.051"	1	C14052-051	\$107.24
87mm	.040"	1	C14056-040	\$107.24
87mm	.051"	1	C14056-051	\$107.24
87.5mm	.045"	1	C4576-045	\$107.24
88.5mm	.045"	1	C4283-045	\$107.24

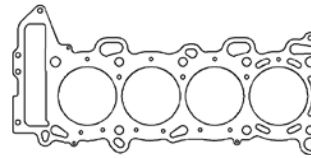

Additional thicknesses available
see pages 2 - 4

MLX Head Gaskets

Bore	Thickness	Pkg Qty	Part No.	Retail
87mm	.040"	1	C4950-040	\$137.57
88mm	.040"	1	C4951-040	\$137.57

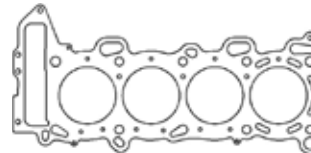

Individual Gaskets

Valve Cover Gasket Set

Application	Part No.	Retail
SR20DE/DET S14 93-96	C4755	\$25.98

Throttle Body Gasket

Application	Part No.	Retail
SR20DE/DET S14 93-96	C4754-032	\$3.66

Intake Manifold Gasket Set

Application	Part No.	Retail
SR20DE/DET S14 93-96	C4749	\$23.03

Thermostat Gasket Set

Application	Part No.	Retail
SR20DE/DET S14 93-96	C4758	\$4.65

Exhaust Manifold Gasket Set

Application	Part No.	Retail
SR20DE/DET S14 93-96 MLS	C4200-030	\$33.43

Rear Main Seal Set

Application	Part No.	Retail
SR20DE/DET S14 93-96	C4743	\$38.85

Valve Stem Seals (sold individually)

Application	Part No.	Retail
SR20DE/DET S14 - EXH	3158V	\$1.61
SR20DE/DET S14 - INT	3175V	\$1.71

Front Crank Seal

Application	Part No.	Retail
SR20DE/DET S14 93-96	C4915	\$6.43

Gasket Kit



To purchase a complete gasket kit order both top end and bottom end gasket kit

TOP END GASKET KIT



Application	Part No.	Retail
SR20DE/DET S14 93-96 87.5mm Bore	PRO2009T	\$225.08

BOTTOM END GASKET KIT

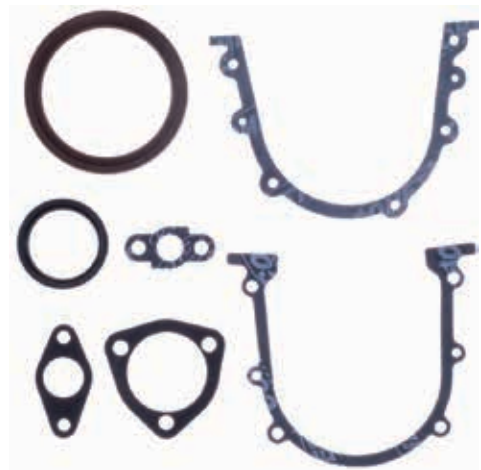

Application	Part No.	Retail
SR20DE/DET S14 93-96	PRO2010B	\$62.18

NISSAN

2.0L SR20DE/DET DOHC GTiR RNN14 AWD 1990-94

Head Gaskets

MLS Head Gaskets				
Bore	Thickness	Pkg Qty	Part No.	Retail
87.5mm	.040"	1	C4543-040	\$107.24
88mm	.040"	1	C4577-040	\$107.24

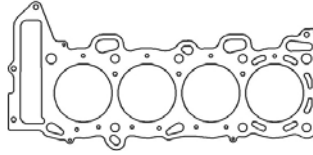

Additional thicknesses available
see pages 2 - 4

Individual Gaskets

Valve Cover Gasket Set		
Application	Part No.	Retail
SR20DE/DET GTiR RNN14	C4747	\$34.31

Throttle Body Gasket		
Application	Part No.	Retail
SR20DE/DET GTiR RNN14	C4756-018	\$13.15

Intake Manifold Gasket Set		
Application	Part No.	Retail
SR20DE/DET GTiR RNN14	C4757-018	\$15.56

Thermostat Gasket Set		
Application	Part No.	Retail
SR20DE/DET GTiR RNN14	C4758	\$4.65

Exhaust Manifold Gasket Set		
Application	Part No.	Retail
SR20DE/DET GTiR RNN14 MLS	C4200-030	\$33.43

Rear Main Seal Set		
Application	Part No.	Retail
SR20DE/DET GTiR RNN14	C4743	\$38.85

Valve Stem Seals (sold individually)		
Application	Part No.	Retail
SR20DE/DET GTiR - EXH	3158V	\$1.61
SR20DE/DET GTiR - INT	3175V	\$1.71

Front Crank Seal		
Application	Part No.	Retail
SR20DE/DET GTiR RNN14	C4915	\$6.43

Gasket Kits



To purchase a complete gasket kit order both top end and bottom end gasket kit

TOP END GASKET KIT

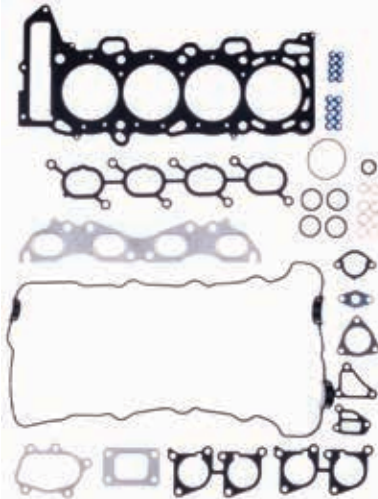

Application	Part No.	Retail
SR20DE/DET GTiR RNN14 87.5mm Bore	PRO2010T	\$225.08

BOTTOM END GASKET KIT

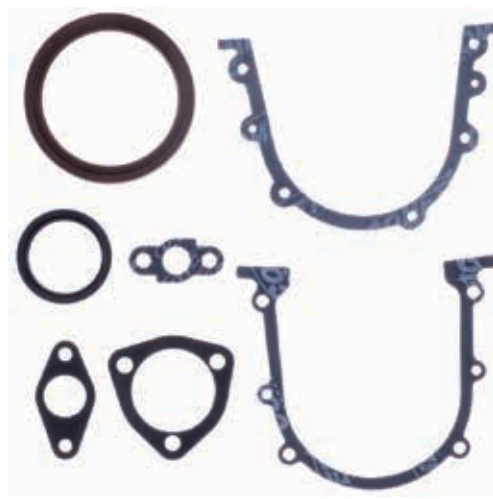

Application	Part No.	Retail
SR20DE/DET GTiR RNN14	PRO2010B	\$62.18

2.0L RB20E/DE/DET Inline 6 Laurel 1988-93, Skyline R32 1988-93, Cefiro 1988-93

Head Gaskets

MLS Head Gaskets - RB20DE/RB20DET				
Bore	Thickness	Pkg Qty	Part No.	Retail
80mm	.040"	1	C4495-040	\$201.10
80mm	.051"	1	C4495-051	\$201.10

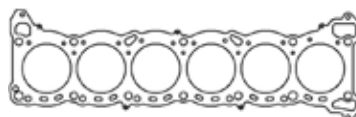

Additional thicknesses available
see pages 2 - 4

See page 132 for additional gaskets



NISSAN

2.0L RB20E/DE/DET Inline 6 Laurel 1988-93, Skyline R32 1988-93, Cefiro 1988-93 (continued)

Individual Gaskets

Valve Cover Gasket Set		
Application	Part No.	Retail
RB20E/DE/DET 88-93	C4552	\$41.19

Intake Manifold Gasket Set		
Application	Part No.	Retail
RB20E/DE/DET 88-93	C4759	\$56.74

Exhaust Manifold Gasket		
Application	Part No.	Retail
RB20E/DE/DET 88-93 MLS	C4177-030	\$30.94

Cam Seal Set		
Application	Part No.	Retail
RB20E/DE/DET 88-93 (pair)	C4739	\$10.73

Valve Stem Seals (sold individually)		
Application	Part No.	Retail
RB20E/DE/DET 88-93	3175V	\$1.71

Throttle Body Gasket		
Application	Part No.	Retail
RB20E/DE/DET 88-93	C4733-018	\$3.40

Rear Main Seal		
Application	Part No.	Retail
RB20E/DE/DET 88-93	C4770	\$15.61

Oil Pump Gasket		
Application	Part No.	Retail
RB20E/DE/DET 88-93	C4769-020	\$8.51

Front Crank Seal		
Application	Part No.	Retail
RB20E/DE/DET 88-93	C4914	\$5.38

Oil Pan Gasket		
Application	Part No.	Retail
RB20/RB25 88-02	C14117-094	\$67.97

Gasket Kits



To purchase a complete gasket kit order both top end and bottom end gasket kit

TOP END GASKET KIT

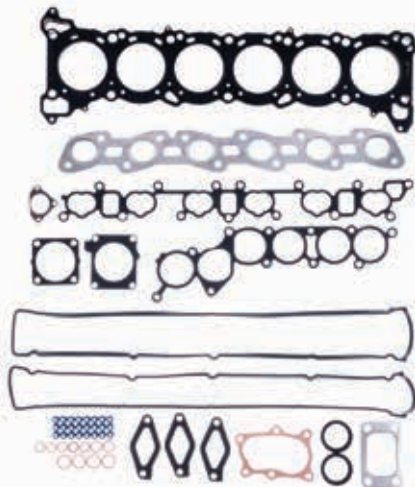

Application	Part No.	Retail
RB20E/DE/DET 88-93 80mm Bore	PRO2015T	\$297.93

BOTTOM END GASKET KIT

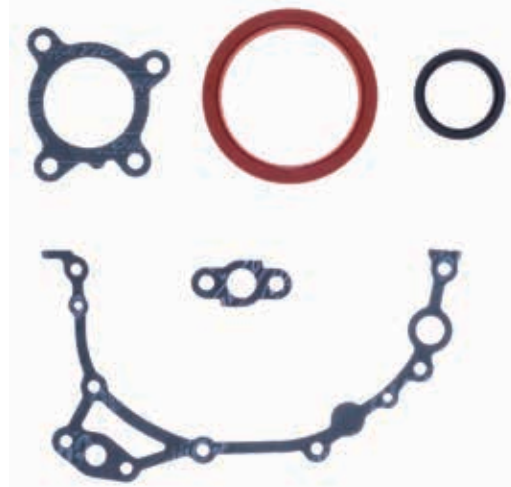

Application	Part No.	Retail
RB20E/DE/DET 88-93	PRO2017B	\$62.18

2.4L KA24DE DOHC: 1991-98 240SX

Head Gaskets

MLS Head Gaskets				
Bore	Thickness	Pkg Qty	Part No.	Retail
90mm	.040"	1	C4285-040	\$107.24
91mm	.040"	1	C4286-040	\$107.24

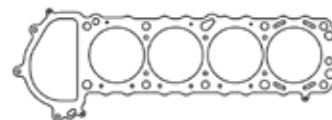

Additional thicknesses available see pages 2 - 4

Individual Gaskets

Valve Cover Gasket Sets		
Application	Part No.	Retail
KA24DE 1991-94	C4761	\$27.46
KA24DE 1995-98	C4766	\$41.96

Oil Pan Gasket		
Application	Part No.	Retail
KA24DE 1991-98	C4764-060	\$14.13

See page 133 for additional gaskets

NISSAN

2.4L KA24DE DOHC: 1991-98 240SX (continued)

Individual Gaskets (continued)

Intake Manifold Gasket Set		
Application	Part No.	Retail
KA24DE 1991-98	C4760	\$21.81

Exhaust Manifold Gasket		
Application	Part No.	Retail
KA24DE 1991-98 MLS	C4201-030	\$33.43

Throttle Body Gasket		
Application	Part No.	Retail
KA24DE 1991-98	C4733-018	\$3.40

Valve Stem Seals (sold individually)		
Application	Part No.	Retail
KA24DE 1991-98	3158V	\$1.61

Water Pump Gasket		
Application	Part No.	Retail
KA24DE 1991-98	C4765-031	\$3.72

Rear Main Seal Set		
Application	Part No.	Retail
KA24DE 1991-98	C4763	\$16.07

Thermostat Gasket Set		
Application	Part No.	Retail
KA24DE 1991-98	C4762	\$4.37

Front Crank Seal		
Application	Part No.	Retail
KA24DE 1991-98	C4915	\$6.43

Gasket Kits



To purchase a complete gasket kit order both top end and bottom end gasket kit

TOP END GASKET KITS

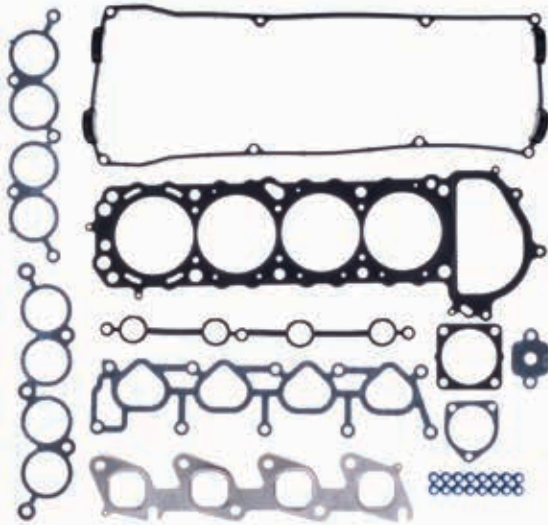

Application	Part No.	Retail
KA24DE 1991-94 90mm Bore	PRO2014T	\$172.11
KA24DE 1995-98 90mm Bore	PRO2013T	\$172.11

BOTTOM END GASKET KIT

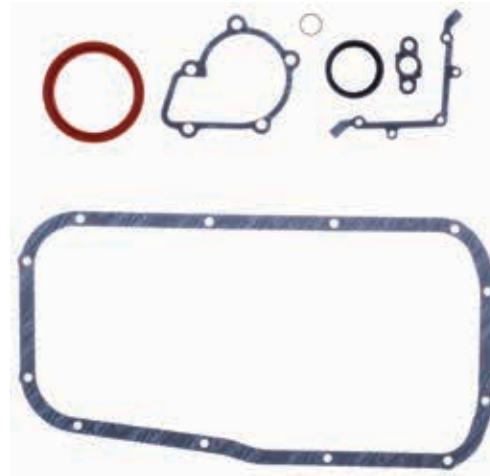

Application	Part No.	Retail
KA24DE 1991-98	PRO2014B	\$62.18

2.5L QR25DE DOHC 2002-06 FWD: Sentra SE-R/SE-R Spec V, Altima Base/S/SL

Head Gasket

MLS Head Gasket				
Bore	Thickness	Pkg Qty	Part No.	Retail
90mm	.030"	1	C4615-030	\$107.24

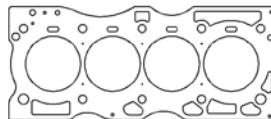

Additional thicknesses available
see pages 2 - 4

Individual Gaskets

Intake Manifold Gasket Set		
Application	Part No.	Retail
QR25DE FWD 02-06	C4748	\$36.24

Throttle Body Gasket		
Application	Part No.	Retail
QR25DE FWD 02-06	C4911	\$8.67



NISSAN

2.5L QR25DE DOHC 2007-12 FWD: Sentra SE-R/SE-R Spec V, Altima Base/S/Hybrid, Rogue S/SL/S Krom/SV

Head Gasket

MLS Head Gasket				
Bore	Thickness	Pkg Qty	Part No.	Retail
90mm	.030"	1	C4614-030	\$107.24

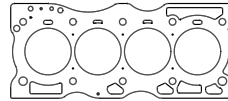

Additional thicknesses available see pages 2 - 4

Individual Gaskets

Water Inlet Gasket		
Application	Part No.	Retail
QR25DE FWD 07-12	C4751	\$5.42

Water Outlet Gasket		
Application	Part No.	Retail
QR25DE FWD 07-12	C4917	\$6.75

Throttle Body Gasket		
Application	Part No.	Retail
Throttle Body Gasket 2007-12 QR25DE	C14004	\$5.73

2.5L QR25DE DOHC 2005-12 RWD: 05-10 Frontier XE, 08-10 Frontier SE, 05 X-Trail LE/SE/XE, 11-12 Frontier S/SV

Head Gasket

MLS Head Gasket				
Bore	Thickness	Pkg Qty	Part No.	Retail
90mm	.030"	1	C4616-030	\$107.24



Additional thicknesses available see pages 2 - 4

Individual Gaskets

Water Outlet Gasket		
Application	Part No.	Retail
QR25DE RWD 05-12	C4918	\$6.75

Water Pump Gasket Set		
Application	Part No.	Retail
QR25DE RWD 05-12	C4919	\$24.16

2.5L QR25DE DOHC 2013-20, QR25DER 2014-17: 2013-18 Altima, 2016 Murano, 2014-15 Pathfinder, 2014-20 Rogue, 2014-17 QX60

Head Gasket

MLS HP Head Gasket				
Bore	Thickness	Pkg Qty	Part No.	Retail
90.5mm	.020"	1	C14172-020	\$112.35

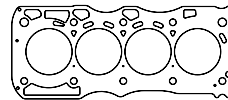

Additional thicknesses available see pages 2 - 4

L14, L16, L18, L20B : 1977-79 200SX, 1968-79 510, 1969-72 521, 1973-76 610, 1972-79 620, 1974-77 710, 1980 720

NEW!

Head Gasket

MLS Head Gaskets				
Bore	Thickness	Pkg Qty	Part No.	Retail
86mm	.050"	1	C14199-050	137.55

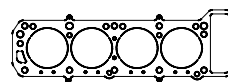

Additional thicknesses available see pages 2 - 4

L23, L24S, L24E, L26 Non-Turbo Inline 6 1970-84: 240/260/280Z, Cedric, Fairlady, Datsun 810, Maxima

Head Gasket

MLS Head Gasket				
Bore	Thickness	Pkg Qty	Part No.	Retail
85mm	.036"	1	C4579-036	\$201.12
85mm	.040"	1	C4579-040	\$201.12
85mm	.070"	1	C4579-070	\$240.83

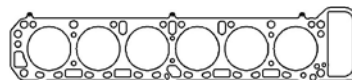

Additional thicknesses available see pages 2 - 4

NISSAN

L28E, L28S, L28ES Non-Turbo Inline 6 1975-80: 280Z, 280ZX Patrol, Fairlady, Dedic, Laurel

Head Gasket

MLS Head Gasket				
Bore	Thickness	Pkg Qty	Part No.	Retail
89mm	.040"	1	C4580-040	\$201.12

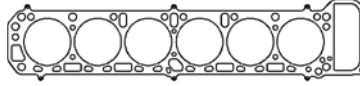

Additional thicknesses available
see pages 2 - 4

RB25DET 2.5L Inline 6: Patrol 89-93, Skyline 89-93, Skyline GT-R 89-02

Head Gaskets

MLS Head Gaskets				
Bore	Thickness	Pkg Qty	Part No.	Retail
86mm	.051"	1	C4317-051	\$201.10
87mm	.051"	1	C4318-051	\$201.10

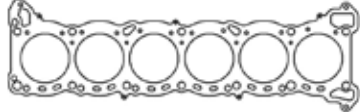

Additional thicknesses available
see pages 2 - 4

Individual Gaskets

Valve Cover Gasket Set			
Application	Part No.	Retail	
RB25DET	C4552	\$41.19	

Throttle Body Gasket		
Application	Part No.	Retail
RB25DET	C4767	\$3.40

Intake Manifold Gasket Set			
Application	Part No.	Retail	
RB25DET	C4768	\$41.35	

Rear Main Seal			
Application	Part No.	Retail	
RB20E/DE/DET 88-93	C4770	\$15.61	

Exhaust Manifold Gasket			
Application	Part No.	Retail	
RB25DET MLS	C4177-030	\$30.94	

Oil Pump Gasket			
Application	Part No.	Retail	
RB20E/DE/DET 88-93	C4769-020	\$8.51	

Cam Seal Set			
Application	Part No.	Retail	
RB25DET (pair)	C4739	\$10.73	

Front Crank Seal			
Application	Part No.	Retail	
RB20E/DE/DET 88-93	C4914	\$5.38	

Valve Stem Seals (sold individually)			
Application	Part No.	Retail	
RB25DET	3175V	\$1.71	

Oil Pan Gasket			
Application	Part No.	Retail	
RB20 /RB RB25 88-02	C14117-094	\$67.97	

Gasket Kits



To purchase a complete gasket kit order both top end and bottom end gasket kit

TOP END GASKET KIT

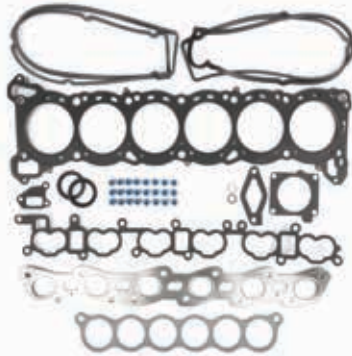

Application	Part No.	Retail
RB25DET 87mm Bore	PRO2016T	\$324.54

BOTTOM END GASKET KIT

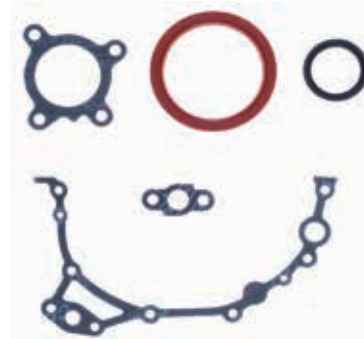

Application	Part No.	Retail
RB25DET	PRO2017B	\$62.18



NISSAN

RB26DET 2.6L DOHC Inline 6 Patrol 89-93, Skyline 89-93, Skyline GT-R 89-02

Head Gaskets

MLS Head Gaskets				
Bore	Thickness	Pkg Qty	Part No.	Retail
86mm	.051"	1	C4319-051	\$201.10
87mm	.051"	1	C4320-051	\$201.10
88mm	.051"	1	C4321-051	\$201.10

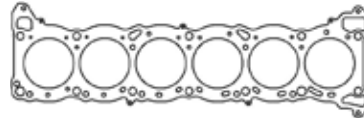

Additional thicknesses available see pages 2 - 4

Individual Gaskets

Valve Cover Gasket Set		
Application	Part No.	Retail
RB26DET	C4552	\$41.19

Throttle Body Gasket Set		
Application	Part No.	Retail
RB26DET - 6 Pack	C4920	\$38.98

Intake Manifold Gasket		
Application	Part No.	Retail
RB26DET	C4372	\$25.34

Rear Main Seal		
Application	Part No.	Retail
RB20E/DE/DET 88-93	C4770	\$15.61

Exhaust Manifold Gasket		
Application	Part No.	Retail
RB26DET MLS	C4202-030	\$30.94

Oil Pump Gasket		
Application	Part No.	Retail
RB20E/DE/DET 88-93	C4769-020	\$8.51

Cam Seal Set		
Application	Part No.	Retail
RB26DET (pair)	C4739	\$10.73

Front Crank Seal		
Application	Part No.	Retail
RB20E/DE/DET 88-93	C4914	\$5.38

Valve Stem Seals (sold individually)		
Application	Part No.	Retail
RB25DET - EXH	3158V	\$1.61
RB25DET - INT	3175V	\$1.71

Gasket Kits



To purchase a complete gasket kit order both top end and bottom end gasket kit

TOP END GASKET KIT

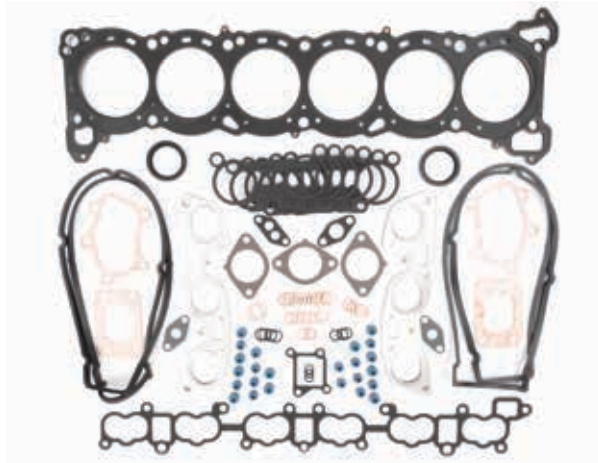

Application	Part No.	Retail
RB26DET 87mm Bore	PRO2017T	\$421.92

BOTTOM END GASKET KIT

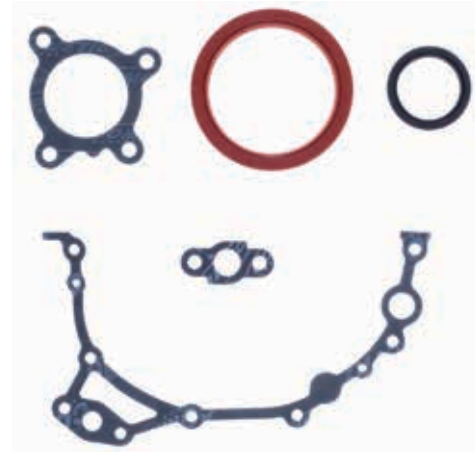

Application	Part No.	Retail
RB26DET	PRO2017B	\$62.18

NISSAN

RB30E/RB30ET/RB30S 3.0L DOHC Inline 6: Patrol 87-97, R31 Skyline 86-89, Holden Commodore VL 86-88

Head Gaskets

MLS Head Gaskets

Bore	Thickness	Pkg Qty	Part No.	Retail
86mm	.051"	1	C4322-051	\$201.10
87mm	.051"	1	C4323-051	\$201.10

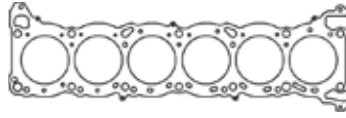

Additional thicknesses available
see pages 2 - 4

Individual Gaskets

Exhaust Manifold Gasket Set

Application	Part No.	Retail
RB30E/RB30ET/RB30S	C14126-030	\$33.46

VG30DE/DETT 3.0L 24v DOHC V6 1990-99

Head Gaskets

MLS Head Gaskets

Bore	Thickness	Pkg Qty	Part No.	Retail
88mm	.045"	1	C4346-045	\$107.24
90mm	.045"	1	C4347-045	\$107.24

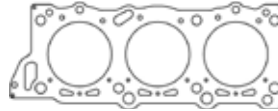

Additional thicknesses available
see pages 2 - 4

Individual Gaskets

Valve Cover Gasket Set

Application	Part No.	Retail
VG30DE/DETT	C4773	\$34.31

Oil Pan Gasket

Application	Part No.	Retail
VG30DE/DETT	C4776	\$20.77

Intake Manifold Gasket Set

Application	Part No.	Retail
VG30DE/DETT	C4772	\$33.89

Rear Main Seal Set

Application	Part No.	Retail
VG30DE/DETT	C4775	\$35.70

Exhaust Manifold Gasket Set

Application	Part No.	Retail
VG30DE/DETT	C4771-064	\$55.57

Front Crank Seal

Application	Part No.	Retail
VG30DE/DETT	C4914	\$5.38

Thermostat Gasket

Application	Part No.	Retail
VG30DE/DETT	C4774-031	\$2.79

Water Pump Gasket

Application	Part No.	Retail
VG30DE/DETT	C4777-015	\$2.82

Cam Seals (sold in pairs)

Application	Part No.	Retail
VG30DE/DETT (need 2 pairs)	C4739	\$10.73

Gasket Kits



To purchase a complete gasket kit order both top end and bottom end gasket kit

TOP END GASKET KIT

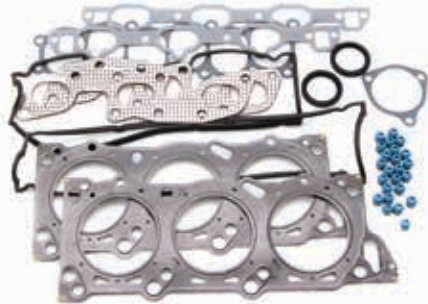

Application	Part No.	Retail
VG30DE/DETT 88mm Bore	PRO2040T	\$304.54

BOTTOM END GASKET KIT

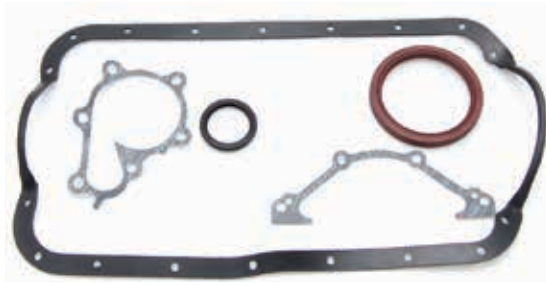

Application	Part No.	Retail
VG30DE/DETT	PRO2040B-2	\$52.50



NISSAN

VQ30DE 3.0L DOHC V6: 1995-99 Nissan Maxima, 1996-99 Infiniti I30

NEW!

Head Gaskets

MLS Head Gaskets - Rear

Bore	Thickness	Pkg Qty	Part No.	Retail
93.5mm	.030"	1	C14164-030	\$110.74

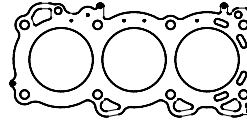

Additional thicknesses available
see pages 2 - 4

NEW!

MLS Head Gaskets - Front

Bore	Thickness	Pkg Qty	Part No.	Retail
93.5mm	.030"	1	C14165-030	\$110.74

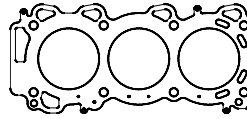

VQ35DE 3.5L DOHC V6: 01-04 Nissan Pathfinder, 01-03 Infiniti QX4

NEW!

Head Gaskets

MLS Head Gaskets - Rear

Bore	Thickness	Pkg Qty	Part No.	Retail
96mm	.030"	1	C14203-030	\$110.74

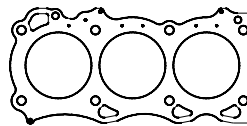

Additional thicknesses available
see pages 2 - 4

NEW!

MLS Head Gaskets - Front

Bore	Thickness	Pkg Qty	Part No.	Retail
96mm	.030"	1	C14204-030	\$110.74

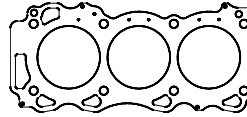

VQ35DE V1/VQ40DE 3.5L/4.0L DOHC V6: 350Z 03-06, G35 03-05, Altima 02-06, I35 02-04, Maxima 02-08, Pathfinder 05-12

Head Gaskets

MLS Head Gaskets - Left Side

Bore	Thickness	Pkg Qty	Part No.	Retail
96mm	.030"	1	C4345-030	\$110.74
98mm	.030"	1	C4344-030	\$110.74
100mm	.030"	1	C4343-030	\$110.74
101.5mm	.030"	1	C4381-030	\$110.74

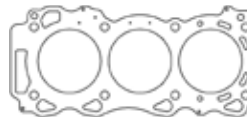

Additional thicknesses available
see pages 2 - 4

MLS Head Gaskets - Right Side

Bore	Thickness	Pkg Qty	Part No.	Retail
96mm	.030"	1	C4361-030	\$110.74
98mm	.030"	1	C4362-030	\$110.74
100mm	.030"	1	C4363-030	\$110.74
101.5mm	.030"	1	C4380-030	\$110.74



Individual Gaskets

Exhaust Manifold Gasket Set

Application	Part No.	Retail
VQ30DE/VQ35DE	C4921-064	\$33.25

VQ35DE V2/VQ35HR/VQ37VHR 3.5/3.7L DOHC V6: G35 07-08, 350Z 07-08, G37 08-Up, 370Z 09-Up

Head Gaskets

MLS Head Gasket - Left Side

Bore	Thickness	Pkg Qty	Part No.	Retail
97mm	.030"	1	C4593-030	\$110.74
97mm	.075"	1	C4593-075	\$144.49

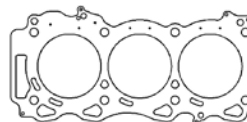

Additional thicknesses available
see pages 2 - 4

MLS Head Gasket - Right Side

Bore	Thickness	Pkg Qty	Part No.	Retail
97mm	.030"	1	C4592-030	\$110.74
97mm	.075"	1	C4592-075	\$144.49

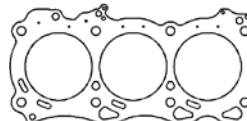

See page 139 for additional gaskets

NISSAN

VQ35DE V2/VQ35HR/VQ37VHR 3.5/3.7L DOHC V6: G35 07-08, 350Z 07-08, G37 08-Up, 370Z 09-Up (continued)

Individual Gaskets

Exhaust Manifold Gasket Set

Application	Part No.	Retail
VQ35HR/VQ37VHR	C4921-064	\$33.25

VR38DETT 3.8L DOHC V6: GT-R 08-Up

Head Gaskets

MLX Head Gaskets - Left Side

Bore	Thickness	Pkg Qty	Part No.	Retail
96mm	.032"	1	C4570-032	\$110.88
100mm	.032"	1	C4572-032	\$110.88

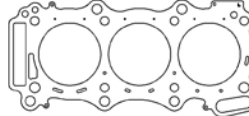

Additional thicknesses available
see pages 2 - 4

MLX Head Gaskets - Right Side

Bore	Thickness	Pkg Qty	Part No.	Retail
96mm	.032"	1	C4571-032	\$110.88
100mm	.032"	1	C4573-032	\$110.88

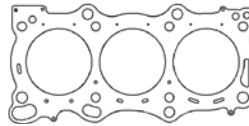

Individual Gaskets

Throttle Body Gasket

Application	Part No.	Retail
Throttle Body Gasket 2009-Up VR38DETT	C14004	\$5.73

VK45DE 4.5L V8 Infinity Q45 02-06

Head Gaskets

MLS Head Gasket - Left Side

Bore	Thickness	Pkg Qty	Part No.	Retail
93.5mm	.036"	1	C4486-036	\$106.44

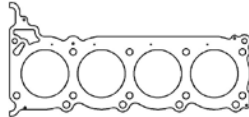

Additional thicknesses available
see pages 2 - 4

MLS Head Gasket - Right Side

Bore	Thickness	Pkg Qty	Part No.	Retail
93.5mm	.036"	1	C4485-036	\$106.44

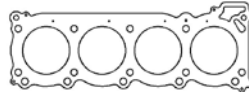

TB48DE 4.8L DOHC Inline 6 2001-Up

Head Gaskets

MLS Head Gasket

Bore	Thickness	Pkg Qty	Part No.	Retail
100.5mm	.030"	1	C4511-030	\$201.10

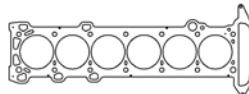

Additional thicknesses available
see pages 2 - 4

MLX Head Gasket

Bore	Thickness	Pkg Qty	Part No.	Retail
100.5mm	.040"	1	C4599-040	\$268.83

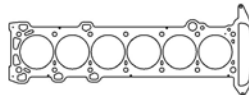

CEV8D1 5.0L DOHC Cummins Nissan Titan XD

Individual Gaskets

Oil Pan Gaskets

Application	Part No.	Retail
Lower Engine Oil Pan	C14001	\$31.98
6 Speed Transmission Oil Pan	C14002	\$25.40
7 Speed Oil Pan (Gas Engine)	C14003	\$25.40

Front Differential Gasket

Application	Part No.	Retail
4WD - 16 Bolt Differential	C14006-060	\$29.47

Crankshaft Seal

Application	Part No.	Retail
Rear Main Seal Retainer Gasket	C14023	\$11.10



NISSAN

VK50VE 5.0L DOHC V8: 2009-2013 FX50, 2014 QX70

Head Gaskets

MLX Head Gaskets - Left Side

Bore	Thickness	Pkg Qty	Part No.	Retail
96mm	.032"	1	C14189-032	\$132.81
96mm	.052"	1	C14189-052	\$156.31

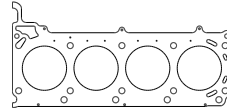

Additional thicknesses available
see pages 2 - 4

MLX Head Gaskets - Right Side

Bore	Thickness	Pkg Qty	Part No.	Retail
96mm	.032"	1	C14188-032	\$132.81
96mm	.052"	1	C14188-052	\$156.31

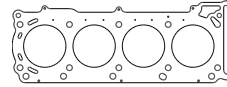

VK56DE 5.6L DOHC V8: 2004-15 Armada, 2004-15 Titan, 2004-10 QX56, 2004-12 Pathfinder

Head Gaskets

MLS Head Gasket - Left Side

Bore	Thickness	Pkg Qty	Part No.	Retail
100mm	.040"	1	C4922-040	\$106.44

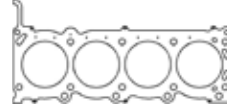

Additional thicknesses available
see pages 2 - 4

MLS Head Gasket - Right Side

Bore	Thickness	Pkg Qty	Part No.	Retail
100mm	.040"	1	C4923-040	\$106.44



MLX Head Gasket - Left Side

Bore	Thickness	Pkg Qty	Part No.	Retail
102.7mm	.040"	1	C4610-040	\$150.39

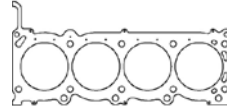

MLX Head Gasket - Right Side

Bore	Thickness	Pkg Qty	Part No.	Retail
102.7mm	.040"	1	C4609-040	\$150.39

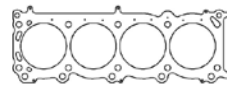

Individual Gaskets

Exhaust Manifold Gasket Set

Application	Part No.	Retail
VK56VD 2010-2016 MLS	C4959-030	\$66.97

Exhaust Manifold Gasket Set

Application	Part No.	Retail
VK56DE 2004-09 Oval Port MLS	C4961-030	\$66.97
VK56DE 2004-09 Oval Port AM	C4967-064	\$35.31

Oil Pan Gasket

Application	Part No.	Retail
Nissan/Suzuki VK56DE, VQ40, VQ40DE 05-17	C14114-060	\$14.96

VK56VD 5.6L DOHC V8: 2017+ Armada, 2017+ Titan

Head Gaskets

MLX Head Gaskets - Left Side

Bore	Thickness	Pkg Qty	Part No.	Retail
99.5mm	.032"	1	C14183-032	\$118.28

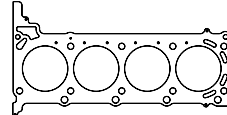

Additional thicknesses available
see pages 2 - 4

MLX Head Gaskets - Right Side

Bore	Thickness	Pkg Qty	Part No.	Retail
99.5mm	.032"	1	C14182-032	\$118.28

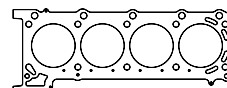

PEUGEOT/CITROËN

TU5J4 1.6L 16v: 106 1997-05

Head Gaskets

MLS Head Gasket

Bore	Thickness	Pkg Qty	Part No.	Retail
79mm	.060"	1	C4493-060	\$152.34

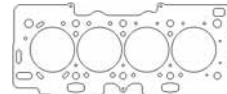

Additional thicknesses available
see pages 2 - 4



PEUGEOT/CITROËN

XU9J4, XU9J4Z 1.9L DOHC, XU10J2, XU10J4 2.0L: 405 M1-16, 605 S/SR1

Head Gaskets

MLS Head Gaskets

Bore	Thickness	Pkg Qty	Part No.	Retail
84mm	.051"	1	C4225-051	\$120.63
85mm	.051"	1	C4226-051	\$120.63
86.5mm	.051"	1	C4227-051	\$120.63
88mm	.051"	1	C4228-051	\$120.63

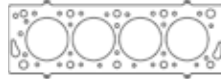

Additional thicknesses available
see pages 2 - 4

XU10J4RS 2.0L DOHC

Head Gaskets

MLS Head Gaskets

Bore	Thickness	Pkg Qty	Part No.	Retail
86.5mm	.051"	1	C4520-051	\$120.63
88mm	.051"	1	C4521-051	\$120.63

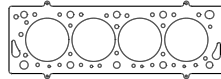

Additional thicknesses available
see pages 2 - 4

PORSCHE

924 2.0L 1976-85

Head Gasket

MLS Head Gasket

Bore	Thickness	Pkg Qty	Part No.	Retail
88mm	.050"	1	C4542-050	\$137.55

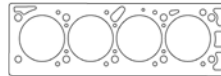

Additional thicknesses available
see pages 2 - 4

944 2.5L 1982-91

Head Gaskets

MLS Head Gasket

Bore	Thickness	Pkg Qty	Part No.	Retail
100.5mm	.040"	1	C4272-040	\$107.24
103mm	.040"	1	C4273-040	\$107.24

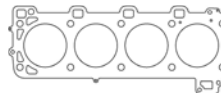

Additional thicknesses available
see pages 2 - 4

Individual Gaskets

Cam Cover Gasket

Application	Part No.	Retail
944 2.5L 82-91	C4925	\$33.44

Intake Manifold Gasket Set

Application	Part No.	Retail
944 2.5L 82-91 - 4pcs	C4924	\$10.22

944 2.7L 1989, 3.0L 1989-91

Head Gasket

MLS Head Gasket

Bore	Thickness	Pkg Qty	Part No.	Retail
106mm	.040"	1	C4274-040	\$107.24

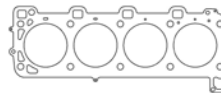

Additional thicknesses available
see pages 2 - 4

996 3.6L 2002-2005 Carrera & Carrera S, 997 3.6L 2005-2008 Carrera, 987 3.4L 2006-2008 Caymen S, 987 3.4L 2007-2008 Boxter S

Head Gasket

MLX Head Gasket

Bore	Thickness	Pkg Qty	Part No.	Retail
97.5mm	.032"	1	C14194-032	\$110.88

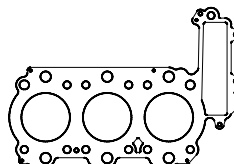

Additional thicknesses available
see pages 2 - 4



PORSCHE

996 3.6L 2001-05 Turbo, 2005 Turbo S, 2002-2005 GT2, 2001-2005 GT3

Head Gasket

MLS Head Gasket				
Bore	Thickness	Pkg Qty	Part No.	Retail
102mm	.040"	1	C4492-040	\$107.24
104mm	.040"	1	C14077-040	\$107.24
104.5mm	.030"	1	C14076-030	\$107.24

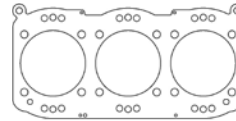

Additional thicknesses available
see pages 2 - 4

997 3.6L 2007-09 Turbo, 2007-2008 GT3/GT3RS, 2008-2009 GT2, 2011 GT2 RS

Head Gasket

MLS Head Gasket				
Bore	Thickness	Pkg Qty	Part No.	Retail
106.5mm	.030"	1	C14049-030	\$107.24

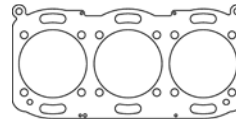

Additional thicknesses available
see pages 2 - 4

997 3.8L M97.01 2005-08

Head Gasket

MLX Head Gasket				
Bore	Thickness	Pkg Qty	Part No.	Retail
102mm	.032"	1	C4926-032	\$110.88

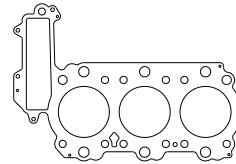

Additional thicknesses available
see pages 2 - 4

997.2 3.8L Turbo 2010-2013, 991/991.2 3.8/4.0L Turbo/GT3 2014-2019

Head Gaskets

MLX Head Gaskets - CYL 1-3 Left Side				
Bore	Thickness	Pkg Qty	Part No.	Retail
105mm	.032"	1	C14142-032	\$110.88
105mm	.040"	1	C14142-040	\$110.88
105mm	.052"	1	C14142-052	\$110.88

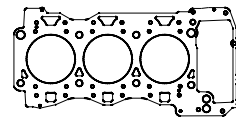

Additional thicknesses available
see pages 2 - 4

MLX Head Gaskets - CYL 4-6 Right Side				
Bore	Thickness	Pkg Qty	Part No.	Retail
105mm	.032"	1	C14143-032	\$110.88
105mm	.040"	1	C14143-040	\$110.88
105mm	.052"	1	C14143-052	\$110.88

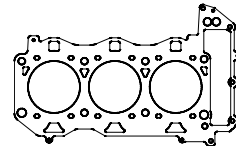

Cayenne GTS 4.5L 2003-06 V8

Head Gaskets

MLS Head Gasket - Left Side				
Bore	Thickness	Pkg Qty	Part No.	Retail
95mm	.027"	1	C4535-027	\$107.24

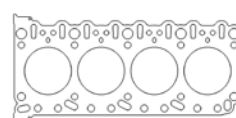

Additional thicknesses available
see pages 2 - 4

MLS Head Gasket - Right Side				
Bore	Thickness	Pkg Qty	Part No.	Retail
95mm	.027"	1	C4536-027	\$107.24

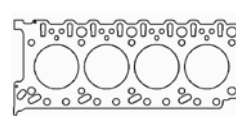

Individual Gaskets

Intake Manifold Gasket Set		
Application	Part No.	Retail
Cayenne 4.5L 03-06 (pair)	C4927	\$31.01



PORSCHE

928 5.0/5.4L 1985-95

Head Gaskets

MLS Head Gaskets - Left Side

Bore	Thickness	Pkg Qty	Part No.	Retail
100mm	.045"	1	C5781-045	\$107.24
104mm	.045"	1	C5783-045	\$107.24

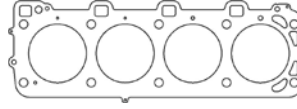

Additional thicknesses available
see pages 2 - 4

MLS Head Gaskets - Right Side

Bore	Thickness	Pkg Qty	Part No.	Retail
100mm	.045"	1	C5780-045	\$107.24
104mm	.045"	1	C5782-045	\$107.24

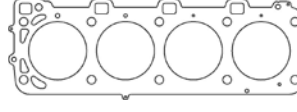

RENAULT

F4P 16v 1.8L, F4R 16v 2.0L: Laguna 98-Up, Clio 01-Up

Head Gaskets

MLS Head Gaskets

Bore	Thickness	Pkg Qty	Part No.	Retail
83mm	.030"	1	C4518-030	\$120.63
84.5mm	.030"	1	C4519-030	\$120.63

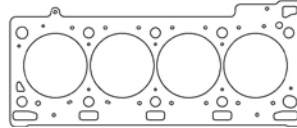

Additional thicknesses available
see pages 2 - 4

F7P 16v 1.8L, F7R 16v 2.0L: R19 89-96, Clio 91-97, Megane Coupe 95-99, Clio Williams 93-95, Spider Sport 1995

Head Gaskets

MLS Head Gaskets

Bore	Thickness	Pkg Qty	Part No.	Retail
83mm	.051"	1	C4539-051	\$120.63
84mm	.051"	1	C4540-051	\$120.63

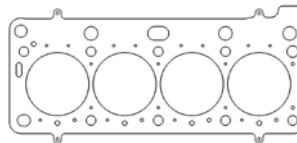

Additional thicknesses available
see pages 2 - 4

ROVER

15G V8 1970-93, 21D-25D V8 1970-93, 35D-38D 1970-93: Range Rover 1970-89, Discovery 1989-93

Head Gaskets

MLS Head Gasket

Bore	Thickness	Pkg Qty	Part No.	Retail
89mm	.040"	1	C4367-040	\$109.90
94mm	.040"	1	C4368-040	\$109.90
96mm	.040"	1	C4369-040	\$109.90

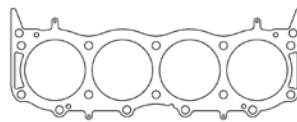

Additional thicknesses available
see pages 2 - 4

Individual Gaskets

Exhaust Manifold Gasket Set

Application	Part No.	Retail
Rover V8 .064" AM	C4966-064	\$31.43



ROVER

35D-38D, 40D, 42D-46D V8 1994-Up: Discovery 1994-Up

Head Gaskets

MLS Head Gaskets

Bore	Thickness	Pkg Qty	Part No.	Retail
89mm	.040"	1	C4366-040	\$109.90
94mm	.040"	1	C4365-040	\$109.90
96mm	.040"	1	C4364-040	\$109.90

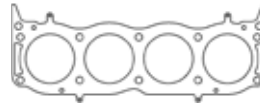

Additional thicknesses available
see pages 2 - 4

Individual Gaskets

Exhaust Manifold Gasket Set

Application	Part No.	Retail
Rover V8 .064" AM	C4966-064	\$31.43

5.0L V8 "LR-V8": 2009-Up Discovery, Range Rover Sport, Range Rover Sport SC, Range Rover, Range Rover SC

Head Gaskets

MLX Head Gaskets - Left Side

Bore	Thickness	Pkg Qty	Part No.	Retail
93mm	.040"	1	C15001-040	\$118.28

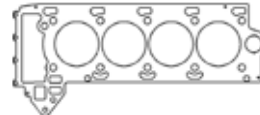

Additional thicknesses available
see pages 2 - 4

MLX Head Gaskets - Right Side

Bore	Thickness	Pkg Qty	Part No.	Retail
93mm	.040"	1	C15000-040	\$118.28

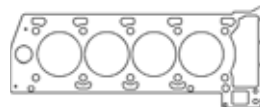

SAAB

B204 1985cc/B234 2290cc Turbo 2.0L: 1995-99 9-3, 9-5, 900

Head Gaskets

MLS Head Gaskets

Bore	Thickness	Pkg Qty	Part No.	Retail
91mm	.030"	1	C4974-030	\$134.02

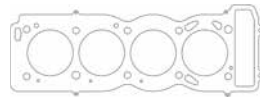

Additional thicknesses available
see pages 2 - 4

B205 1985cc/B235 2290cc Turbo 2.0L: 1999-09 9-3, 9-5

Head Gaskets

MLS Head Gaskets

Bore	Thickness	Pkg Qty	Part No.	Retail
91mm	.030"	1	C4973-030	\$134.02

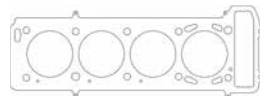

Additional thicknesses available
see pages 2 - 4

SUBARU

FA20F DOHC 2.0L: 2015+Up WRX 2014+Up Forester XT

Head Gaskets

MLX Head Gasket - Left Side

Bore	Thickness	Pkg Qty	Part No.	Retail
89.5mm	.032"	1	C4954-032	\$85.13

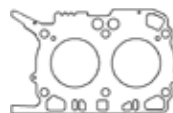

Additional thicknesses available
see pages 2 - 4

MLX Head Gasket - Right Side

Bore	Thickness	Pkg Qty	Part No.	Retail
89.5mm	.032"	1	C4955-032	\$85.13

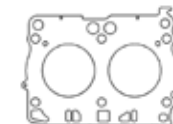

See page 145 for additional gaskets



SUBARU

FA20F DOHC 2.0L: 2015+Up WRX 2014+Up Forester XT (continued)

Individual Gaskets

Exhaust Gaskets

Application	Part No.	Retail
FA20F DOHC 2.0L	C4204-030	\$20.55

FA20D DOHC 2.0L: 2012+Up BRZ/FRS/86

Head Gaskets

MLX Head Gasket - Left Side

Bore	Thickness	Pkg Qty	Part No.	Retail
89.5mm	.032"	1	C4589-032	\$85.13

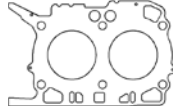

Additional thicknesses available
see pages 2 - 4

MLX Head Gasket - Right Side

Bore	Thickness	Pkg Qty	Part No.	Retail
89.5mm	.032"	1	C4588-032	\$85.13

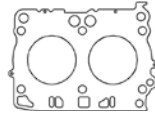

Individual Gaskets

Intake Manifold Gasket Set

Application	Part No.	Retail
FA20 - Driver Side and Passenger Side	C14025	\$21.79

Throttle Body Gasket

Application	Part No.	Retail
FA20 2012 BRZ+	C14024	\$6.57

Exhaust Gaskets

Application	Part No.	Retail
MLS 1.825" Round Port / .030" Thick	C4204-030	\$20.55

FB20B/FB20X DOHC 2.0L: 2012-2016 Impreza, 2013-17 Crosstrek

Head Gaskets

MLX Head Gasket - Left Side

Bore	Thickness	Pkg Qty	Part No.	Retail
85.7mm	.032"	1	C14158-032	\$85.13

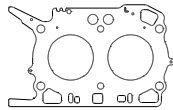

Additional thicknesses available
see pages 2 - 4

MLX Head Gasket - Right Side

Bore	Thickness	Pkg Qty	Part No.	Retail
85.7mm	.032"	1	C14157-032	\$85.13

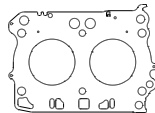

Individual Gaskets

Intake Manifold Gaskets

Application	Part No.	Retail
FB20B 2011-17	C14166	\$31.49

Exhaust Gaskets

Application	Part No.	Retail
FB20B/FB20X DOHC 2.0L	C4204-030	\$20.55

FA24F DOHC 2.4L: 2019+ Ascent, 2022+ Outback XT, 2022+ Legacy XT, 2022+ WRX

Head Gaskets

MLX Head Gasket - Left Side

Bore	Thickness	Pkg Qty	Part No.	Retail
95.8mm	.032"	1	C14180-032	\$85.13

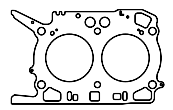

Additional thicknesses available
see pages 2 - 4

MLX Head Gasket - Right Side

Bore	Thickness	Pkg Qty	Part No.	Retail
95.8mm	.032"	1	C14179-032	\$85.13

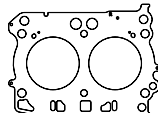



SUBARU

FB25B DOHC 2.5L: 2011-18 Forester, 2013-19 Outback, 2013-19 Legacy

Head Gaskets

MLX Head Gasket - Left Side				
Bore	Thickness	Pkg Qty	Part No.	Retail
95.5mm	.032"	1	C14156-032	\$85.13

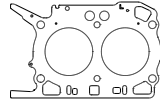

Additional thicknesses available
see pages 2 - 4

MLX Head Gasket - Right Side				
Bore	Thickness	Pkg Qty	Part No.	Retail
95.5mm	.032"	1	C14155-032	\$85.13

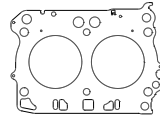

Individual Gaskets

Intake Manifold Gaskets			
Application	Part No.	Retail	
FB25BA, FB25BC 2011-17	C14166	\$31.49	

Exhaust Gaskets		
Application	Part No.	Retail
FB25B DOHC 2.5L	C4204-030	\$20.55

FB25D DOHC 2.5L: 2019-2022 Forester, 2020-2023 Outback, 2020-2023 Legacy

Head Gaskets

MLX Head Gasket - Left Side				
Bore	Thickness	Pkg Qty	Part No.	Retail
95.8mm	.036"	1	C14178-036	\$104.74

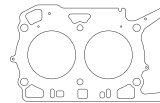

Additional thicknesses available
see pages 2 - 4

MLX Head Gasket - Right Side				
Bore	Thickness	Pkg Qty	Part No.	Retail
95.8mm	.036"	1	C14177-036	\$104.74

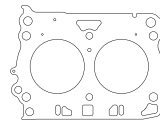

EJ20E SOHC 2.0L 16v JDM 1990-97 Legacy, 1995-97 Impreza

Head Gasket

MLS Head Gasket				
Bore	Thickness	Pkg Qty	Part No.	Retail
93mm	.040"	1	C4260-040	\$57.59

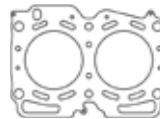

Additional thicknesses available
see pages 2 - 4

EJ205 DOHC 2.0L 16v 2002-05 WRX, 2004-05 Saab 9-2X Aero

Head Gasket

MLX Head Gasket				
Bore	Thickness	Pkg Qty	Part No.	Retail
93mm	.041"	1	C4590-041	\$85.13

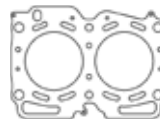

Additional thicknesses available
see pages 2 - 4

Individual Gaskets

Valve Cover Gasket Sets		
Application	Part No.	Retail
EJ205 02-05 - Left Side	C4863	\$54.00
EJ205 02-05 - Right Side	C4864	\$38.44

Valve Stem Seals (sold individually)		
Application	Part No.	Retail
EJ205 02-05 - Exhaust (Brown)	3264V	\$2.03
EJ205 02-05 - Intake (Black)	3265V	\$2.60

Intake Manifold Gaskets		
Application	Part No.	Retail
EJ205 02-05	C4857-039	\$24.00

Rear Main Seal		
Application	Part No.	Retail
EJ205 02-05	C4856	\$18.06

See page 147 for additional gaskets

SUBARU

EJ205 DOHC 2.0L 16v 2002-05 WRX, 2004-05 Saab 9-2X Aero (continued)

Individual Gaskets (continued)

Exhaust Gaskets		
Application	Part No.	Retail
EJ205 02-05 Manifold MLS (2)	C4204-030	\$20.55
EJ205 02-05 Exhaust Pipe (2)	C4856-064	\$10.74
EJ205 02-05 Crossover (2)	C4859-064	\$11.34
EJ205 02-05 Turbo To Up Pipe Gasket (1)	C5723-030	\$10.37
EJ205 02-05 Turbo To Downpipe Gasket (1)	C5736-030	\$10.37

Throttle Body Gasket		
Application	Part No.	Retail
EJ205 02-05	C4855-060	\$6.57

Cam Seal Set		
Application	Part No.	Retail
EJ205 02-05 - 4 Pack	C4858	\$29.45

Front Crank Seal		
Application	Part No.	Retail
EJ205 02-05	C4947	\$7.67

Water Pump Gasket		
Application	Part No.	Retail
EJ205 02-05	C4860-018	\$6.75

Thermostat Gasket		
Application	Part No.	Retail
EJ205 02-05	C4861	\$5.47

Gasket Kits

To purchase a complete gasket kit order both top end and bottom end gasket kit

TOP END GASKET KIT



Application	Part No.	Retail
EJ205 02-03 93.5mm Bore	PRO2044C	\$418.44

BOTTOM END GASKET KIT

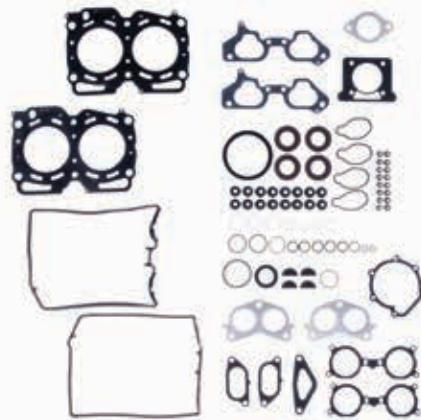

Application	Part No.	Retail
EJ205 04-05	PRO2023C	\$317.79

EJ22E SOHC 2.2L 16v 1990-96 Legacy, 1993-96 Impreza

Head Gasket

MLS Head Gasket				
Bore	Thickness	Pkg Qty	Part No.	Retail
98mm	.040"	1	C4262-040	\$57.59
100mm	.040"	1	C4985-040	\$57.59

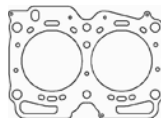

Additional thicknesses available
see pages 2 - 4

MLX Head Gasket				
Bore	Thickness	Pkg Qty	Part No.	Retail
101mm	.041"	1	C4986-041	\$85.13

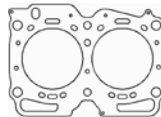

Individual Gaskets

Valve Cover Gasket Set		
Application	Part No.	Retail
EJ22E SOHC	C4871	\$48.95

Thermostat Gasket		
Application	Part No.	Retail
EJ22E SOHC	C4861	\$5.47

Intake Manifold Gasket Set		
Application	Part No.	Retail
EJ22E SOHC	C4868-060	\$21.35

Oil Pan Gasket		
Application	Part No.	Retail
EJ22E SOHC - Cork	C4869-125	\$12.90

See page 148 for additional gaskets



SUBARU

EJ22E SOHC 2.2L 16v 1990-96 Legacy, 1993-96 Impreza (continued)

Individual Gaskets (continued)

Exhaust Gaskets		
Application	Part No.	Retail
EJ22E SOHC MLS	C4204-030	\$20.55

Throttle Body Gasket		
Application	Part No.	Retail
EJ22E SOHC	C4867-060	\$6.57

Cam Seal Set		
Application	Part No.	Retail
EJ22E SOHC - 2 pack	C4870	\$19.73

Valve Stem Seals (sold individually)		
Application	Part No.	Retail
EJ22E SOHC - Exhaust (Brown)	3264V	\$2.03
EJ22E SOHC - Intake (Black)	3265V	\$2.60

Rear Main Seal		
Application	Part No.	Retail
EJ22E SOHC	C4856	\$18.06

Front Crank Seal		
Application	Part No.	Retail
EJ22E SOHC	C4947	\$7.67

Water Pump Gasket		
Application	Part No.	Retail
EJ22E SOHC	C4860-018	\$6.75

Timing Cover Set		
Application	Part No.	Retail
EJ22E SOHC	C4862	\$68.00

Gasket Kit



To purchase a complete gasket kit order both top end and bottom end gasket kit

TOP END GASKET KIT



Application	Part No.	Retail
EJ22E SOHC 98mm Bore	PRO2026C	\$311.18

EJ22T SOHC 2.2L 16v Turbo: 1991-94 Legacy

Head Gasket

MLS Head Gasket				
Bore	Thickness	Pkg Qty	Part No.	Retail
98mm	.051"	1	C4263-051	\$57.59

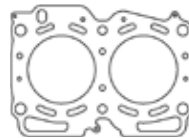

Additional thicknesses available
see pages 2 - 4

Individual Gaskets

Valve Cover Gasket Set		
Application	Part No.	Retail
EJ22T SOHC Turbo	C4871	\$48.95

Intake Manifold Gasket Set		
Application	Part No.	Retail
EJ22T SOHC Turbo	C4868-060	\$21.35

Exhaust Gaskets		
Application	Part No.	Retail
EJ22T SOHC MLS	C4204-030	\$20.55

Cam Seal Set		
Application	Part No.	Retail
EJ22T SOHC Turbo - 2pcs	C4870	\$19.73

Oil Pan Gasket		
Application	Part No.	Retail
EJ22T SOHC Turbo	C4869-125	\$12.90

Rear Main Seal		
Application	Part No.	Retail
EJ22T SOHC Turbo	C4856	\$18.06

Front Crank Seal		
Application	Part No.	Retail
EJ22T SOHC Turbo	C4947	\$7.67

Water Pump Gasket		
Application	Part No.	Retail
EJ22T SOHC Turbo	C4860-018	\$6.75

See page 149 for additional gaskets

EJ22T SOHC 2.2L 16v Turbo: 1991-94 Legacy (continued)

Individual Gaskets (continued)

Valve Stem Seals (sold individually)

Application	Part No.	Retail
EJ22T SOHC - Exhaust (Brown)	3264V	\$2.03
EJ22T SOHC - Intake (Black)	3265V	\$2.60

EJ25D DOHC 2.5L 16v 1998 Impreza RS, 1996-99 Legacy/Outback, 1998 Forester

Head Gasket

MLX Head Gasket

Bore	Thickness	Pkg Qty	Part No.	Retail
101mm	.052"	1	C4578-052	\$85.13



Additional thicknesses available
see pages 2 - 4

Individual Gaskets

Valve Cover Gasket Set

Application	Part No.	Retail
EJ25D DOHC	C4873	\$114.22

Intake Manifold Gasket Set

Application	Part No.	Retail
EJ25D DOHC	C4872-059	\$30.87

Exhaust Gaskets

Application	Part No.	Retail
EJ25D DOHC MLS	C4204-030	\$20.55

Throttle Body Gasket

Application	Part No.	Retail
EJ25D DOHC	C4867-060	\$6.57

Cam Seal Set

Application	Part No.	Retail
EJ25D DOHC - 4pcs	C4866	\$39.46

Valve Stem Seals (sold individually)

Application	Part No.	Retail
EJ25D DOHC - Exhaust (Brown)	3264V	\$2.03
EJ25D DOHC - Intake (Black)	3265V	\$2.60

Thermostat Gasket

Application	Part No.	Retail
EJ25D DOHC	C4861	\$5.47

Oil Pan Gasket

Application	Part No.	Retail
EJ25D DOHC - Cork	C4869-125	\$12.90

Timing Cover Set

Application	Part No.	Retail
EJ25D DOHC	C4862	\$68.00

Rear Main Seal

Application	Part No.	Retail
EJ25D DOHC	C4856	\$18.06

Front Crank Seal

Application	Part No.	Retail
EJ25D DOHC	C4947	\$7.67

Water Pump Gasket

Application	Part No.	Retail
EJ25D DOHC	C4860-018	\$6.75

Gasket Kit

To purchase a complete gasket kit order both top end and bottom end gasket kit

TOP END GASKET KIT



Application	Part No.	Retail
EJ25D DOHC 1996-99 101mm Bore	PRO2025C	\$395.93



SUBARU

EJ251/EJ253 SOHC 2.5L 16v (EJ251): 09/00-03/03 Impreza, 00-02,04 Outback Sport, 11/01-03/04 Forester, 06/99-06/06 Legacy/Outback, 06/02-04/06 Baja (EJ253): 01/04-Up Forester, 04/03+Up Impreza, 11/03-04/09 Legacy/Outback

Head Gasket

MLX Head Gasket				
Bore	Thickness	Pkg Qty	Part No.	Retail
101mm	.032"	1	C4578-032	\$85.13

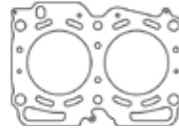

Additional thicknesses available see pages 2 - 4

Individual Gaskets

Valve Cover Gasket Set		
Application	Part No.	Retail
EJ251 SOHC	C4642	\$41.19

Throttle Body Gasket		
Application	Part No.	Retail
EJ251 SOHC	C4874-060	\$6.57

Intake Manifold Gasket Set		
Application	Part No.	Retail
EJ251 SOHC	C4875-060	\$24.00

Thermostat Gasket		
Application	Part No.	Retail
EJ251 SOHC	C4861	\$5.47

Exhaust Gaskets		
Application	Part No.	Retail
EJ251 SOHC MLS	C4204-030	\$20.55

Rear Main Seal		
Application	Part No.	Retail
EJ251 SOHC	C4856	\$18.06

Cam Seal Set		
Application	Part No.	Retail
EJ251 SOHC 2pcs	C4870	\$19.73

Front Crank Seal		
Application	Part No.	Retail
EJ251 SOHC	C4947	\$7.67

Valve Stem Seals (sold individually)		
Application	Part No.	Retail
EJ251 SOHC - Exhaust (Brown)	3264V	\$2.03
EJ251 SOHC - Intake (Black)	3265V	\$2.60

Water Pump Gasket		
Application	Part No.	Retail
EJ251 SOHC	C4860-018	\$6.75

Gasket Kit



To purchase a complete gasket kit order both top end and bottom end gasket kit

GASKET KIT

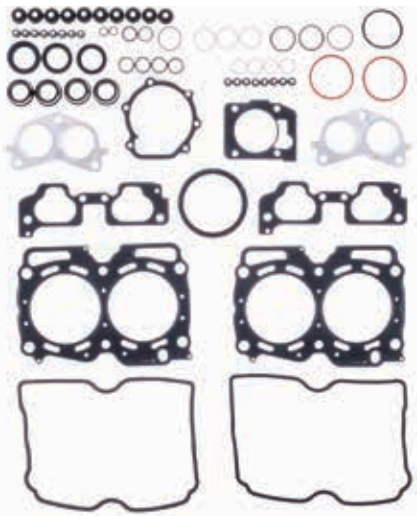

Application	Part No.	Retail
EJ251 SOHC 1999-05 101mm Bore	PRO2022C	\$258.18



SUBARU

EJ253 SOHC 2.5L 16v 02/09-12/14 Legacy/Outback non-turbo

Head Gaskets

MLX Head Gasket - "Improved Cooling Heads"

Bore	Thickness	Pkg Qty	Part No.	Retail
101mm	.032"	1	C4622-032	\$85.13

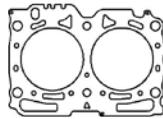

Additional thicknesses available
see pages 2 - 4

Individual Gaskets

Intake Manifold Gasket Set

Application	Part No.	Retail
EJ253 SOHC	C4875-060	\$24.00

Thermostat Gasket

Application	Part No.	Retail
EJ253 SOHC	C4861	\$5.47

Exhaust Gaskets

Application	Part No.	Retail
EJ253 SOHC MLS	C4204-030	\$20.55

Rear Main Seal

Application	Part No.	Retail
EJ253 SOHC	C4856	\$18.06

Cam Seal Set

Application	Part No.	Retail
EJ253 SOHC 2pcs	C4870	\$19.73

Front Crank Seal

Application	Part No.	Retail
EJ253 SOHC	C4947	\$7.67

Valve Stem Seals (sold individually)

Application	Part No.	Retail
EJ253 SOHC - Exhaust (Brown)	3264V	\$2.03
EJ253 SOHC - Intake (Black)	3265V	\$2.60

Water Pump Gasket

Application	Part No.	Retail
EJ253 SOHC	C4860-018	\$6.75

Valve Cover Gasket Set

Application	Part No.	Retail
EJ253 SOHC 2006-12	C14026	\$45.45

Oil Pan Gasket

Application	Part No.	Retail
EJ253 - Cork	C4869-125	\$12.90

EJ255 DOHC 2.5L 16v Turbo 02/03-04/06 Baja Turbo3-03/05 Forester XT, 02/03-06/06 Legacy/Outback Turbo

Head Gasket

MLX Head Gasket

Bore	Thickness	Pkg Qty	Part No.	Retail
101mm	.032"	1	C4578-032	\$85.13



Additional thicknesses available
see pages 2 - 4

EJ255 DOHC 2.5L 16v Turbo 01/05-03/08 Forester XT, 04/05-03/08 Impreza WRX, 11/05-04/09 Legacy/Outback Turbo

Head Gasket

MLX Head Gasket - "Improved Cooling Heads"

Bore	Thickness	Pkg Qty	Part No.	Retail
101mm	.032"	1	C4622-032	\$85.13

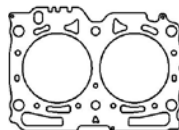

Additional thicknesses available
see pages 2 - 4

Individual Gaskets

Valve Cover Gasket Sets

Application	Part No.	Retail
EJ255 06-07 - Left Side	C4880	\$27.46
EJ255 06-07 - Right Side	C4881	\$27.46

Cam Seal Sets

Application	Part No.	Retail
EJ255 06-07 Exhaust Seals (2)	C4878	\$14.73
EJ255 06-07 Intake Seals (2)	C4879	\$23.55

Intake Manifold Gasket Set

Application	Part No.	Retail
EJ255 DOHC 06-07	C4857-039	\$24.00

Thermostat Gasket

Application	Part No.	Retail
EJ255 DOHC 06-07	C4861	\$5.47

See page 152 for additional gaskets



SUBARU

EJ255 DOHC 2.5L 16v Turbo 01/05-03/08 Forester XT, 04/05-03/08 Impreza WRX, 11/05-04/09 Legacy/Outback Turbo (continued)

Individual Gaskets (continued)

Throttle Body Gasket		
Application	Part No.	Retail
EJ255 DOHC 06-07	C4877-060	\$6.57

Rear Main Seal		
Application	Part No.	Retail
EJ255 DOHC 06-07	C4856	\$18.06

Exhaust Gaskets		
Application	Part No.	Retail
EJ255 06-07 Manifold MLS (2)	C4204-030	\$20.55
EJ255 06-07 Crossover (2)	C4859-064	\$11.34
EJ255 Turbo To Up Pipe Gasket (1)	C5723-030	\$10.37
EJ255 Turbo To Downpipe Gasket (1)	C5736-030	\$10.37

Front Crank Seal		
Application	Part No.	Retail
EJ255 DOHC 06-07	C4947	\$7.67

Valve Stem Seals (sold individually)		
Application	Part No.	Retail
EJ255 DOHC - Exhaust (Brown)	3264V	\$2.03
EJ255 DOHC - Intake (Black)	3265V	\$2.60

Water Pump Gasket		
Application	Part No.	Retail
EJ255 DOHC 06-07	C4860-018	\$6.75

Timing Cover Set		
Application	Part No.	Retail
EJ255 DOHC 06-07	C4862	\$68.00

Gasket Kit



To purchase a complete gasket kit order both top end and bottom end gasket kit

TOP END GASKET KIT

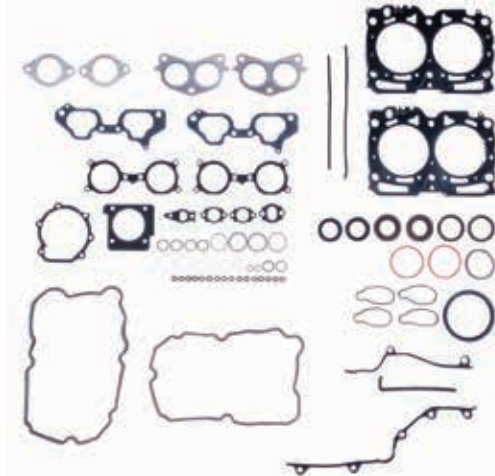

Application	Part No.	Retail
EJ255 DOHC 2006-07 101mm Bore	PRO2045C	\$418.44

EJ255 DOHC 2.5L 16v Turbo 04/08-Up Forester XT, 04/08-Up Impreza WRX, 02/09-Up Legacy/Outback Turbo

Head Gasket

MLX Head Gasket				
Bore	Thickness	Pkg Qty	Part No.	Retail
101mm	.032"	1	C4587-032	\$85.13

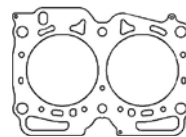

Additional thicknesses available see pages 2 - 4

Individual Gaskets

Valve Cover Gasket Sets		
Application	Part No.	Retail
EJ255 08-Up - Left Side	C4880	\$27.46
EJ255 08-Up - Right Side	C4881	\$27.46

Throttle Body Gasket		
Application	Part No.	Retail
EJ255 DOHC 08-Up	C4882	\$10.49

See page 153 for additional gaskets

SUBARU

EJ255 DOHC 2.5L 16v Turbo 04/08-Up Forester XT, 04/08-Up Impreza WRX, 02/09-Up Legacy/Outback Turbo (continued)

Individual Gaskets (continued)

Intake Manifold Gasket Set		
Application	Part No.	Retail
EJ255 DOHC 08-Up	C4857-039	\$24.00

Thermostat Gasket		
Application	Part No.	Retail
EJ255 DOHC 08-Up	C4861	\$5.47

Exhaust Gaskets		
Application	Part No.	Retail
EJ255 08-Up Manifold MLS (2)	C4204-030	\$20.55
EJ255 Turbo To Up Pipe Gasket (1)	C5723-030	\$10.37
EJ255 Turbo To Downpipe Gasket (1)	C5736-030	\$10.37

Rear Main Seal		
Application	Part No.	Retail
EJ255 DOHC 08-Up	C4856	\$18.06

Front Crank Seal		
Application	Part No.	Retail
EJ255 DOHC 08-Up	C4947	\$7.67

Cam Seal Sets		
Application	Part No.	Retail
EJ255 08-Up Exh Seals (2)	C4878	\$14.73
EJ255 08-Up Intake Seals (2)	C4879	\$23.55

Water Pump Gasket		
Application	Part No.	Retail
EJ255 DOHC 08-Up	C4860-018	\$6.75

Valve Stem Seals (sold individually)		
Application	Part No.	Retail
EJ255 DOHC - Exhaust (Brown)	3264V	\$2.03
EJ255 DOHC - Intake (Black)	3265V	\$2.60

Gasket Kit



To purchase a complete gasket kit order both top end and bottom end gasket kit

TOP END GASKET KIT



Application	Part No.	Retail
EJ255 DOHC 2008-Up 101mm Bore	PRO2046C	\$384.01

EJ257 DOHC 2.5L 16v Turbo: 10/02-06/07 Impreza STi

Head Gasket

MLX Head Gasket				
Bore	Thickness	Pkg Qty	Part No.	Retail
101mm	.032"	1	C4578-032	\$85.13



Additional thicknesses available see pages 2 - 4

See page 154 for additional gaskets

SUBARU

EJ257 DOHC 2.5L 16v Turbo: 10/02-06/07 Impreza STi (continued)

Individual Gaskets

Valve Cover Gasket Sets

Application	Part No.	Retail
EJ257 04-07 - Left Side	C4928	\$27.46
EJ257 04-07 - Right Side	C4929	\$27.46

Intake Manifold Gasket Set

Application	Part No.	Retail
EJ257 DOHC 04-07	C4857-039	\$24.00

Exhaust Gaskets

Application	Part No.	Retail
EJ257 04-07 Manifold MLS (2)	C4204-030	\$20.55
EJ257 04-07 Crossover (1)	C5718	\$5.67
EJ255 Turbo To Up Pipe Gasket (1)	C5723-030	\$10.37
EJ255 Turbo To Downpipe Gasket (1)	C5736-030	\$10.37

Cam Seal Sets

Application	Part No.	Retail
EJ257 04-07 Exh Seals (2)	C4878	\$14.73
EJ257 04-07 Intake Seals (2)	C4879	\$23.55

Valve Stem Seals (sold individually)

Application	Part No.	Retail
EJ257 DOHC - Exhaust (Brown)	3264V	\$2.03
EJ257 DOHC - Intake (Black)	3265V	\$2.60

Throttle Body Gasket

Application	Part No.	Retail
EJ257 DOHC 04-07	C4877-060	\$6.57

Thermostat Gasket

Application	Part No.	Retail
EJ257 DOHC 04-07	C4861	\$5.47

Timing Cover Set

Application	Part No.	Retail
EJ257 DOHC 2007	C4862	\$68.00

Rear Main Seal

Application	Part No.	Retail
EJ257 DOHC 04-07	C4856	\$18.06

Front Crank Seal

Application	Part No.	Retail
EJ257 DOHC 04-07	C4947	\$7.67

Water Pump Gasket

Application	Part No.	Retail
EJ257 DOHC 04-07	C4860-018	\$6.75

Gasket Kits



To purchase a complete gasket kit order both top end and bottom end gasket kit

TOP END GASKET KIT

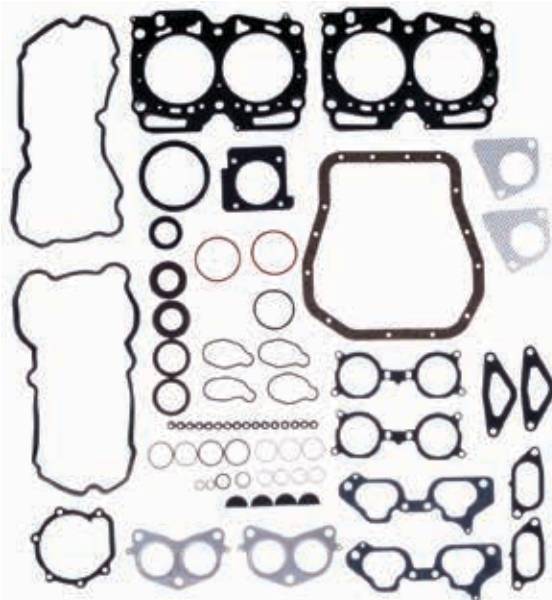

Application	Part No.	Retail
EJ257 DOHC 04-06 101mm Bore	PRO2024C	\$329.71

TOP END GASKET KIT

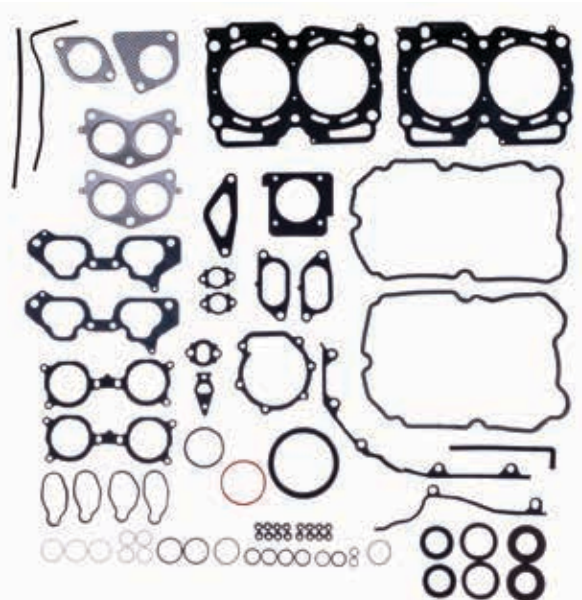

Application	Part No.	Retail
EJ257 DOHC 2007 101mm Bore	PRO2047C	\$391.95

EJ257 DOHC 2.5L 16v Turbo: 2008-2018 Impreza WRX STI

Head Gasket

MLX Head Gasket

Bore	Thickness	Pkg Qty	Part No.	Retail
101mm	.032"	1	C4587-032	\$85.13

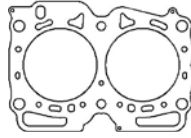

Additional thicknesses available
see pages 2 - 4

Individual Gaskets

Valve Cover Gasket Sets

Application	Part No.	Retail
EJ257 08-Up - Left Side	C4880	\$27.46
EJ257 08-Up - Right Side	C4881	\$27.46

Intake Manifold Gasket Set

Application	Part No.	Retail
EJ257 DOHC 08-Up	C4857-039	\$24.00

Exhaust Gaskets

Application	Part No.	Retail
EJ257 08-Up Manifold MLS (2)	C4204-030	\$20.55
EJ257 08-Up Crossover (1)	C5718	\$5.67
EJ255 Turbo To Up Pipe Gasket (1)	C5723-030	\$10.37
EJ255 Turbo To Downpipe Gasket (1)	C5736-030	\$10.37

Cam Seal Set

Application	Part No.	Retail
EJ257 08+Up 4pcs	C4876	\$47.08

Valve Stem Seals (sold individually)

Application	Part No.	Retail
EJ257 DOHC - Exhaust (Brown)	3264V	\$2.03
EJ257 DOHC - Intake (Black)	3265V	\$2.60

Throttle Body Gasket

Application	Part No.	Retail
EJ257 DOHC 08-Up	C4877-060	\$6.57

Thermostat Gasket

Application	Part No.	Retail
EJ257 DOHC 08-Up	C4861	\$5.47

Timing Cover Set

Application	Part No.	Retail
EJ257 DOHC 08-Up	C4862	\$68.00

Rear Main Seal

Application	Part No.	Retail
EJ257 DOHC 08-Up	C4856	\$18.06

Front Crank Seal

Application	Part No.	Retail
EJ257 DOHC 08-Up	C4947	\$7.67

Water Pump Gasket

Application	Part No.	Retail
EJ257 DOHC 08-Up	C4860-018	\$6.75

Oil Pan Gasket

Application	Part No.	Retail
EJ255/ EJ257 - Cork	C4869-125	\$12.90

Gasket Kit

To purchase a complete gasket kit order both top end and bottom end gasket kit

TOP END GASKET KIT

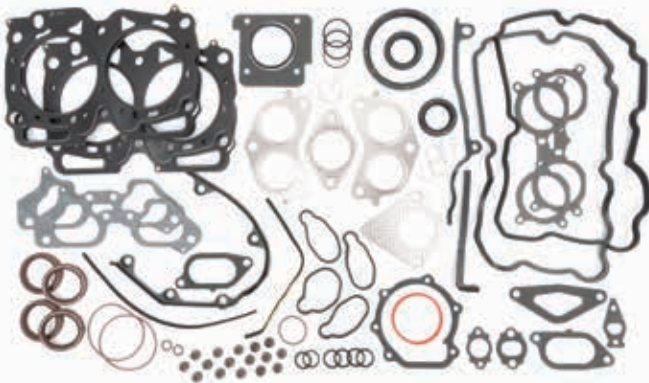

Application	Part No.	Retail
EJ257 DOHC 08-18 101mm Bore	PRO2048C	\$405.09



SUBARU

EJ257 DOHC 2.5L 16v Turbo: 2019-2021 Impreza WRX STI

Head Gaskets

MLX Head Gaskets

Bore	Thickness	Pkg Qty	Part No.	Retail
101.3mm	.036"	1	C14181-036	\$104.74

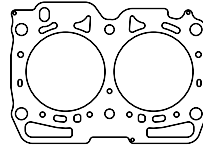

Additional thicknesses available
see pages 2 - 4

EZ30D mk I 3.0L Flat 6: 2000-02 Legacy/Outback

Head Gaskets

MLS Head Gasket - Left Side

Bore	Thickness	Pkg Qty	Part No.	Retail
90mm	.040"	1	C5861-040	\$97.84

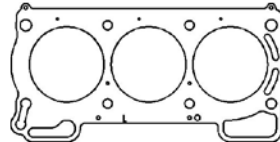

Additional thicknesses available
see pages 2 - 4

MLS Head Gasket - Right Side

Bore	Thickness	Pkg Qty	Part No.	Retail
90mm	.040"	1	C5860-040	\$97.84

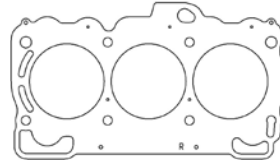

EZ30D mk II 3.0L Flat 6: 2003-09 Legacy/Outback, 2006-07 Tribeca

Head Gaskets

MLS Head Gasket - Left Side

Bore	Thickness	Pkg Qty	Part No.	Retail
90mm	.040"	1	C4623-040	\$97.84

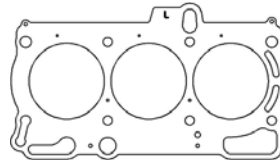

Additional thicknesses available
see pages 2 - 4

MLS Head Gasket - Right Side

Bore	Thickness	Pkg Qty	Part No.	Retail
90mm	.040"	1	C4624-040	\$97.84

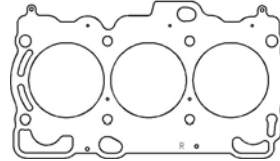

EZ36D 3.6L Flat 6 2010-12 Legacy 3.6R / Outback, 2008-14 Tribeca

Individual Gaskets

Oil Pan Gasket

Application	Part No.	Retail
EJ255/ EJ257/ EZ36D - Cork	C4869-125	\$12.90

EG33 3.3L Flat 6 3318cc 1992-96 SVX

Head Gaskets

MLS Head Gaskets

Bore	Thickness	Pkg Qty	Part No.	Retail
98mm	.066"	1	C4340-066	\$137.55
100mm	.066"	1	C4341-066	\$137.55
102mm	.066"	1	C4342-066	\$137.55

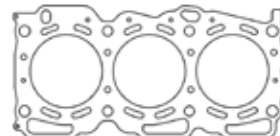

Additional thicknesses available
see pages 2 - 4



TOYOTA

1.3L 4E-FE/4E-FTE/ 1.5L 5E-FE/5E-FHE: 1986-98 Corolla, Corona, Starlet, Tercel, Paseo, Sera

Head Gaskets

MLS Head Gaskets

Bore	Thickness	Pkg Qty	Part No.	Retail
75mm	.040"	1	C4602-040	\$112.58
76mm	.040"	1	C4603-040	\$112.58

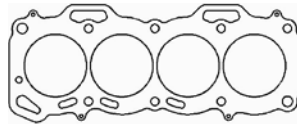

Additional thicknesses available
see pages 2 - 4

2T 1.6L, 2TC 1.6L, 3T 1.8L, 3TC 1.8L 1970-84 Corolla, 1970-76 Sprinter, 1970-76 Celica, 1970-76 Carina, 1970-84 Corona, 1978-84 Camry

Head Gaskets

MLS Head Gaskets

Bore	Thickness	Pkg Qty	Part No.	Retail
87mm	.040"	1	C4258-040	\$107.24
89mm	.040"	1	C4176-040	\$107.24

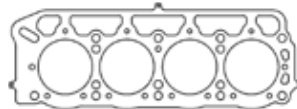

Additional thicknesses available
see pages 2 - 4

Individual Gaskets

Exhaust Manifold Gasket

Application	Part No.	Retail
3TC 1.8L	C4930	\$21.15

4A-GE, 4A-GEC, 4A-GELC, 4A-GEZ 16v 1587cc: 1984-92 Corolla, 1989 Carina, 1989 Sprinter, 1984-89 MR2, 1989-89 Celica

Head Gaskets

MLS Head Gaskets

Bore	Thickness	Pkg Qty	Part No.	Retail
81mm	.040"	1	C4170-040	\$107.24
83mm	.040"	1	C4166-040	\$107.24

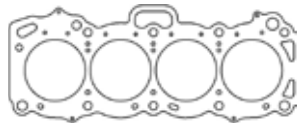

Additional thicknesses available
see pages 2 - 4

Individual Gaskets

Valve Cover Gasket Set

Application	Part No.	Retail
4A-GE 84-92 16v	C4807	\$21.96

Thermostat Gasket

Application	Part No.	Retail
4A-GE 84-92 16v	C4809	\$10.06

Intake Gasket Set

Application	Part No.	Retail
4A-GE 84-92 16v	C4806	\$24.00

Timing Cover Dust Seal Set

Application	Part No.	Retail
4A-GE 84-92 16v	C4811	\$31.45

Exhaust Manifold Gasket

Application	Part No.	Retail
4A-GE 84-92 16v .042" AM	C4805-042	\$21.15

Rear Main Seal

Application	Part No.	Retail
4A-GE 84-92 16v	C4810	\$24.69

Cam Seal Set

Application	Part No.	Retail
4A-GE 84-92 16v 2pcs	C4808	\$18.50

Front Crank Seal

Application	Part No.	Retail
4A-GE 84-92 16v	C4931	\$8.78

Valve Stem Seals (sold individually)

Application	Part No.	Retail
4A-GE 84-92 16v	3225V	\$2.04

Water Pump Gasket

Application	Part No.	Retail
4A-GE 84-92 16v	C4812-039	\$2.43

See page 158 for StreetPro gasket kits

TOYOTA

4A-GE, 4A-GEC, 4A-GELC 16v 1587cc 1984-92 Corolla, 1989 Carina, 1989 Sprinter, 1984-89 MR2, 1989-89 Celica (continued)

Gasket Kits



To purchase a complete gasket kit order both top end and bottom end gasket kit

TOP END GASKET KIT

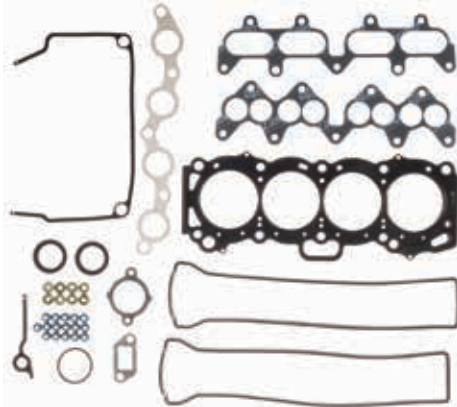

Application	Part No.	Retail
4A-GE 84-92 16v 81mm Bore	PRO2041T	\$251.57

BOTTOM END GASKET KIT



Application	Part No.	Retail
4A-GE 84-92 16v	PRO2041B	\$53.61

4A-GE 1.6L 20v 1587cc 1991-95 Corolla, 1996-01 Carina, 1991-00 Sprinter

Head Gaskets

MLS Head Gaskets

Bore	Thickness	Pkg Qty	Part No.	Retail
81mm	.040"	1	C4604-040	\$107.24
83mm	.040"	1	C4605-040	\$107.24

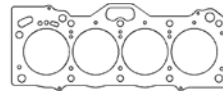

Additional thicknesses available see pages 2 - 4

Individual Gaskets

Intake Manifold Gasket

Application	Part No.	Retail
4A-GE 20v Small Port	C4932-031	\$11.99

Exhaust Manifold Gasket

Application	Part No.	Retail
4A-GE 20v .064" AM	C4933-064	\$21.15

G16E-GTS 1.6L: 2020-2024 GR Yaris, 2023-2024 Toyota GR Corolla

NEW!

Head Gaskets

MLS Head Gaskets

Bore	Thickness	Pkg Qty	Part No.	Retail
89mm	.035"	1	C14201-035	\$121.02

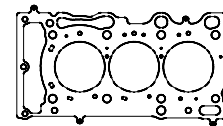

Additional thicknesses available see pages 2 - 4

1ZZ-FE 1.8L DOHC 1997-08

Head Gaskets

MLS Head Gaskets

Bore	Thickness	Pkg Qty	Part No.	Retail
80mm	.027"	1	C4496-027	\$107.24
82mm	.027"	1	C4497-027	\$107.24

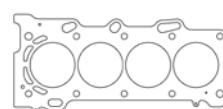

Additional thicknesses available see pages 2 - 4

Individual Gaskets

Intake Manifold Gasket

Application	Part No.	Retail
1ZZ-FE .032" AFM	C4934-032	\$7.25

Exhaust Manifold Gasket

Application	Part No.	Retail
1ZZ-FE 98-02 .030" MLS	C4205-030	\$27.22

1G-GTE 2.0L DOHC 1986-92 Supra

Head Gaskets

MLX Head Gaskets

Bore	Thickness	Pkg Qty	Part No.	Retail
76.5mm	.040"	1	C14162-040	\$212.73

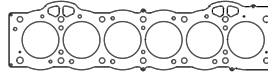

Additional thicknesses available
see pages 2 - 4

2ZZ-GE 1.8L DOHC 1795cc: 2000-05 Celica, 2005-06 Corolla, 2003-06 Matrix/Vibe, 2005-11 Lotus Elise, 2006-10 Lotus Exige

Head Gasket

MLX Head Gasket

Bore	Thickness	Pkg Qty	Part No.	Retail
82.5mm	.028"	1	C4962-028	\$132.81
82.5mm	.040"	1	C4962-040	\$169.68



Additional thicknesses available
see pages 2 - 4

2ZR-FE/2ZR-FAE/2ZR-FEX 1.8L, 3ZR-FAE 2.0L: 2009+ Corolla, 2009-2013 Matrix, 2010-2015 Prius, 2012-2017 Prius V, 2018+ C-HR

Head Gasket

MLS HP Head Gasket

Bore	Thickness	Pkg Qty	Part No.	Retail
81.5mm	.034"	1	C14175-034	\$156.31

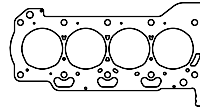

Additional thicknesses available
see pages 2 - 4

3S-GE/3S-GTE 2.0L DOHC Turbo 1998cc 1989-94 Celica, 1990-94 MR2

Head Gasket

MLS Head Gasket

Bore	Thickness	Pkg Qty	Part No.	Retail
87mm	.040"	1	C4314-040	\$107.24

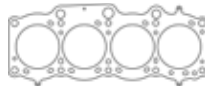

Additional thicknesses available
see pages 2 - 4

Individual Gaskets

Valve Cover Gasket Set

Application	Part No.	Retail
3S-GTE 90-95	C4608	\$45.32

Oil Pan Gasket

Application	Part No.	Retail
3S-GE/GTE 91-95	C4817-062	\$24.26

Intake Manifold Gasket Set

Application	Part No.	Retail
3S-GE/GTE 88-95	C4813	\$24.00

Timing Cover Dust Seal Set

Application	Part No.	Retail
3S-GE/GTE 89-94	C4811	\$31.45

Exhaust Manifold Gasket

Application	Part No.	Retail
3S-GE/GTE 89-95 MLS	C4206-030	\$33.79

Water Pump Gasket

Application	Part No.	Retail
3S-GE/GTE 89-94	C4818-031	\$2.82

Cam Seal Set

Application	Part No.	Retail
3S-GE/GTE 89-95	C4808	\$18.50

Rear Main Seal Set

Application	Part No.	Retail
3S-GE/GTE 89-94	C4815	\$22.59

Valve Stem Seals (sold individually)

Application	Part No.	Retail
3S-GE/GTE 89-95	3225V	\$2.04

Oil Pump Gasket Set

Application	Part No.	Retail
3S-GE/GTE 89-94	C4816	\$11.47

See page 160 for StreetPro gasket kits

TOYOTA

3S-GE/3S-GTE 2.0L DOHC Turbo 1998cc 1989-94 Celica, 1990-94 MR2 (continued)

Gasket Kits



To purchase a complete gasket kit order both top end and bottom end gasket kit

TOP END GASKET KIT

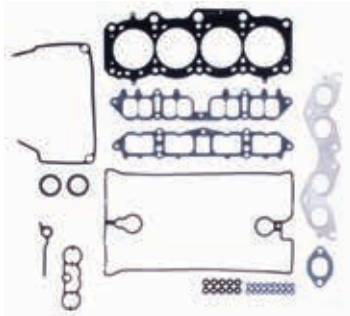

Application	Part No.	Retail
3S-GTE 89-94 87mm Bore	PRO2019T	\$198.59

BOTTOM END GASKET KIT

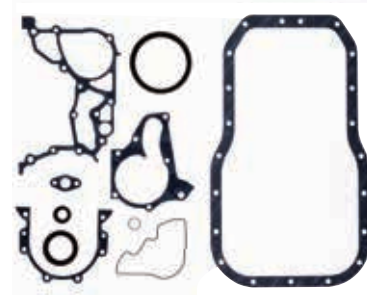

Application	Part No.	Retail
3S-GE/GTE 89-94	PRO2019B	\$83.37

3S-GE/3S-GTE 2.0L DOHC Turbo 3rd Gen, ST205 1994-99

Head Gasket

MLS Head Gasket

Bore	Thickness	Pkg Qty	Part No.	Retail
87mm	.040"	1	C4606-040	\$107.24

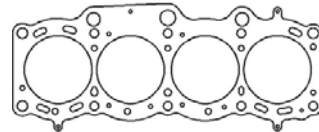

Additional thicknesses available
see pages 2 - 4

4U-GSE DOHC 2.0L 2013-20 Scion, 2017-20 Toyota 86

Head Gasket

MLX Head Gasket - Left Side

Bore	Thickness	Pkg Qty	Part No.	Retail
89.5mm	.032"	1	C4589-032	\$85.13

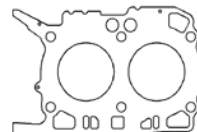

Additional thicknesses available
see pages 2 - 4

MLX Head Gasket - Right Side

Bore	Thickness	Pkg Qty	Part No.	Retail
89.5mm	.032"	1	C4588-032	\$85.13

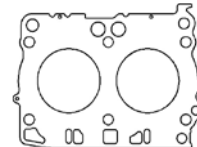

5S-FE 2.2L 2164cc 1990-97 Camry, 1990-97 Celica, 1990-97 MR2

Head Gasket

MLS Head Gasket

Bore	Thickness	Pkg Qty	Part No.	Retail
88mm	.040"	1	C4315-040	\$107.24

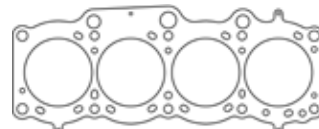

Additional thicknesses available
see pages 2 - 4

See page 161 for additional gaskets

TOYOTA

5S-FE 2.2L 2164cc 1990-97 Camry, 1990-97 Celica, 1990-97 MR2 (continued)

Individual Gaskets

Valve Cover Gasket Set		
Application	Part No.	Retail
5S-FE 1990-97	C4820	\$31.57

Oil Pan Gasket		
Application	Part No.	Retail
5S-FE 1990-97	C4817-062	\$24.26

Intake Manifold Gasket Set		
Application	Part No.	Retail
5S-FE 1990-97	C4819-046	\$3.66

Water Pump Gasket		
Application	Part No.	Retail
5S-FE 1990-97	C4818-031	\$2.82

Exhaust Manifold Gasket		
Application	Part No.	Retail
5S-FE 1990-97 MLS	C4206-030	\$33.79

Rear Main Seal Set		
Application	Part No.	Retail
5S-FE 1990-97	C4823	\$14.95

Cam Seal Set		
Application	Part No.	Retail
5S-FE 1990-97	C4821	\$5.00

Oil Pump Gasket Set		
Application	Part No.	Retail
5S-FE 1990-97	C4824	\$6.67

Valve Stem Seals (sold individually)		
Application	Part No.	Retail
5S-FE 1990-97	3225V	\$2.04

Thermostat Gasket Set		
Application	Part No.	Retail
5S-FE 1990-97	C4822	\$8.48

Gasket Kits

STREETpro
by Cometic Gasket

To purchase a complete gasket kit order both top end and bottom end gasket kit

TOP END GASKET KIT



Application	Part No.	Retail
5S-FE 1990-97 88mm Bore	PRO2042T	\$225.08

BOTTOM END GASKET KIT

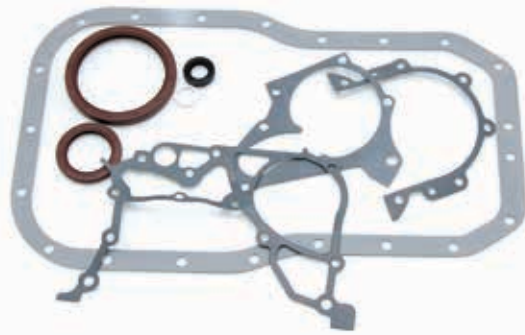

Application	Part No.	Retail
5S-FE 1990-97	PRO2042B	\$46.62

22R/22R-TEC 2.4L 1982-85 Celica, 1981-95 Hi-Lux, 1981-82 Corona, 1984-95 4 Runner

Head Gasket

MLS Head Gasket				
Bore	Thickness	Pkg Qty	Part No.	Retail
92mm	.040"	1	C4268-040	\$107.24
93mm	.040"	1	C14086-040	\$107.24
94mm	.040"	1	C14074-040	\$107.24
95mm	.040"	1	C4269-040	\$107.24

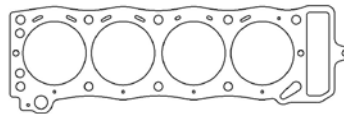

Additional thicknesses available
see pages 2 - 4

Individual Gaskets

Valve Cover Gasket Set		
Application	Part No.	Retail
22R 2.4L 81-85	C4935	\$20.58

Oil Pan Gasket		
Application	Part No.	Retail
22R 2.4L 81-85	C4940	\$23.10

Intake Manifold Gasket Set		
Application	Part No.	Retail
22R 2.4L 81-85	C4936	\$21.81

Water Pump Gasket Set		
Application	Part No.	Retail
22R 2.4L 81-85	C4941	\$7.18

See page 162 for additional gaskets



TOYOTA

22R/22R-TEC 2.4L 1982-85 Celica, 1981-95 Hi-Lux, 1981-82 Corona, 1984-95 4 Runner (continued)

Individual Gaskets (continued)

Exhaust Manifold Gaskets		
Application	Part No.	Retail
22R 2.4L 81-82	C4937-064	\$20.65
22R 2.4L 83-84	C4938-064	\$20.65
22R 2.4L 85-87	C4939-064	\$27.64

Valve Stem Seals (sold individually)		
Application	Part No.	Retail
22R 2.4L 81-85	3157V	\$2.16

Timing Cover Sets		
Application	Part No.	Retail
22R 2.4L 81-84	C4942	\$23.80
22R 2.4L 1985	C4943	\$21.82

Rear Main Seal		
Application	Part No.	Retail
22R 2.4L 81-85	C4944	\$16.32

2RZ-FE 2.4L 1995-04, 3RZ-FE 2.7L 1997-04

Head Gaskets

MLS Head Gaskets				
Bore	Thickness	Pkg Qty	Part No.	Retail
96mm	.040"	1	C4598-040	\$107.24
97mm	.040"	1	C4245-040	\$107.24

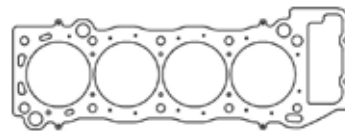

Additional thicknesses available see pages 2 - 4

Individual Gaskets

Valve Cover Gasket Set		
Application	Part No.	Retail
2RZ/3RZ 97-04	C4830	\$41.96

Thermostat Gasket Set		
Application	Part No.	Retail
2RZ/3RZ 97-04	C4831	\$9.28

Intake Manifold Gaskets		
Application	Part No.	Retail
2RZ/3RZ 95-99	C4826-018	\$24.19
2RZ/3RZ 95-99 Plenum	C4827-032	\$24.19
2RZ/3RZ 99-04	C4828-032	\$29.60
2RZ/3RZ 99-04 Plenum	C4829-032	\$29.60

Oil Pan Gasket		
Application	Part No.	Retail
2RZ/3RZ 97-04	C4834	\$24.26

Exhaust Manifold Gasket		
Application	Part No.	Retail
2RZ/3RZ MLS	C4207-030	\$30.94

Timing Cover Sets		
Application	Part No.	Retail
2RZ/3RZ 97-04	C4833	\$4.11

Valve Stem Seals (sold individually)		
Application	Part No.	Retail
2RZ/3RZ 97-04	3225V	\$2.04

Water Pump Gasket		
Application	Part No.	Retail
2RZ/3RZ 97-04	C4835-020	\$8.74

Rear Main Seal Set		
Application	Part No.	Retail
2RZ/3RZ 97-04	C4832	\$31.71

Gasket Kits



To purchase a complete gasket kit order both top end and bottom end gasket kit

TOP END GASKET KIT



Application	Part No.	Retail
2RZ/3RZ 97-04 97mm Bore	PRO2043T	\$311.18

BOTTOM END GASKET KIT



Application	Part No.	Retail
2RZ/3RZ 97-04	PRO2043B	\$82.05

TOYOTA

2AZ-FE 2.4L DOHC 2002-09 Camry, 2009-11 Matrix, 2009-10 Pontiac Vibe, 2009-11 Corolla ZRS, 2002-09 Solara, 2004-08 RAV4, 2001-08 Highlander, 2005-10 Scion tC, 2008-12 Scion xB

Head Gaskets

MLS Head Gaskets				
Bore	Thickness	Pkg Qty	Part No.	Retail
89mm	.027"	1	C4507-027	\$107.24
92mm	.027"	1	C4506-027	\$107.24

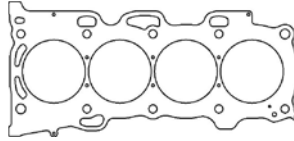

Additional thicknesses available
see pages 2 - 4

Individual Gaskets

Exhaust Manifold Gasket		
Application	Part No.	Retail
2AZ-FE .030" MLS	C4203-030	\$27.22

7M-GE/7M-GTE 3.0L Inline 6 24v 2954cc 1986-92 Supra, 1988-92 Cressida

Head Gaskets

MLS Head Gaskets				
Bore	Thickness	Pkg Qty	Part No.	Retail
84mm	.051"	1	C4278-051	\$201.10
86mm	.051"	1	C4275-051	\$201.10

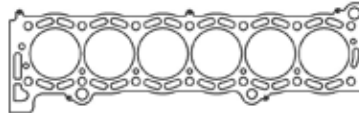

Additional thicknesses available
see pages 2 - 4

Individual Gaskets

Valve Cover Gasket Set		
Application	Part No.	Retail
7M-GE/GTE 86-92	C4838	\$27.46

Thermostat Gasket		
Application	Part No.	Retail
7M-GE/GTE 86-92	C4839	\$5.19

Intake Manifold Gasket Set		
Application	Part No.	Retail
7M-GE/GTE 86-92	C4837-031	\$17.99

Oil Pan Gasket		
Application	Part No.	Retail
7M-GE/GTE 86-92	C4845-062	\$29.77

Exhaust Manifold Gasket		
Application	Part No.	Retail
7M-GE/GTE 86-92 MLS	C4208-030	\$30.94

Timing Cover Set		
Application	Part No.	Retail
7M-GE/GTE 86-92	C4844	\$4.46

Cam Seal Set		
Application	Part No.	Retail
7M-GE/GTE 86-92 2pcs	C4808	\$18.50

Water Pump Gasket Set		
Application	Part No.	Retail
7M-GE/GTE 86-92	C4846-031	\$11.16

Valve Stem Seals (sold individually)		
Application	Part No.	Retail
7M-GE/GTE 86-92	3225V	\$2.04

Rear Main Seal Set		
Application	Part No.	Retail
7M-GE/GTE 86-92	C4843	\$21.00

Throttle Body Gasket		
Application	Part No.	Retail
7M-GE/GTE 86-92	C4836-032	\$6.57

Front Crank/Balance Shaft Seals		
Application	Part No.	Retail
7M-GE/GTE 86-92 Front Crank	C4945	\$6.03
7M-GE/GTE 86-92 Balance Shaft	C4946	\$6.68

See page 164 for StreetPro gasket kits

TOYOTA

7M-GE/7M-GTE 3.0L Inline 6 24v 2954cc 1986-92 Supra, 1988-92 Cressida (continued)

Gasket Kits



To purchase a complete gasket kit order both top end and bottom end gasket kit

TOP END GASKET KIT

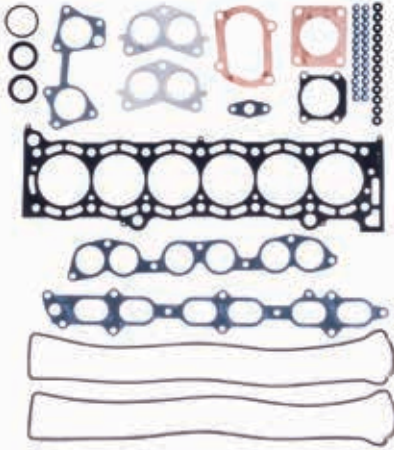

Application	Part No.	Retail
7M-GE/GTE 86-92 84mm Bore	PRO2020T	\$263.50

BOTTOM END GASKET KIT

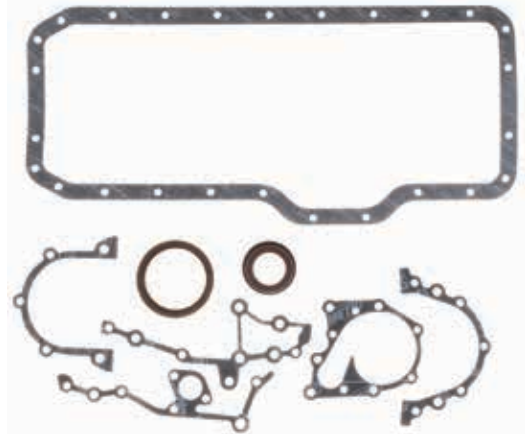

Application	Part No.	Retail
7M-GE/GTE 86-92	PRO2020B	\$62.18

1JZ-GE/GTE 2.5L Inline 6 24v

Head Gaskets

MLS Head Gaskets

Bore	Thickness	Pkg Qty	Part No.	Retail
87mm	.051"	1	C14036-051	\$201.10

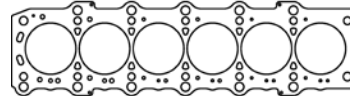

Additional thicknesses available see pages 2 - 4

Individual Gaskets

Turbo Exhaust Manifold Gasket

Application	Part No.	Retail
Turbo Exh. Manifold .060" thick, VVTi Only	C14119-060	\$23.29

Turbo Exhaust Manifold Gasket

Application	Part No.	Retail
Exhaust to Head - Includes 2 Non VVT	C14123-060	\$23.29

2JZ-GE/GTE 3.0L Inline 6 24v: 1993-02 Supra, 1993-03 GS300, 2001-03 IS300, 1993-00 SC300

Head Gasket

MLS Head Gasket

Bore	Thickness	Pkg Qty	Part No.	Retail
87mm	.051"	1	C4276-051	\$201.10
87mm	.060"	1	C4276-060	\$240.83

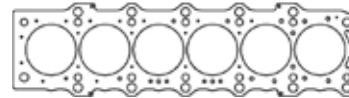

Additional thicknesses available see pages 2 - 4

NEW!

MLX Head Gasket

(Fits Stock 2JZ-GE/GTE & Dart Iron Eagle 2JZ w/ M11x1.25 Studs)

Bore	Thickness	Pkg Qty	Part No.	Retail
87mm	.052"	1	C14016-052	\$267.25
87mm	.062"	1	C14016-062	\$267.25

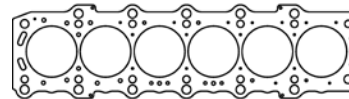

NEW!

MLX Head Gasket

(Fits Stock 2JZ-GE/GTE & Dart Iron Eagle 2JZ w/ 1/2" Studs)

Bore	Thickness	Pkg Qty	Part No.	Retail
87mm	.052"	1	C14212-052	\$267.25
87mm	.062"	1	C14212-062	\$267.25

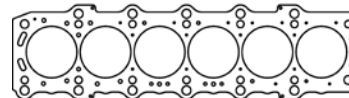

See page 165 for additional gaskets

TOYOTA

2JZ-GE/GTE 3.0L Inline 6 24v: 1993-02 Supra, 1993-03 GS300, 2001-03 IS300, 1993-00 SC300 (continued)

Individual Gaskets

Valve Cover Gasket Set		
Application	Part No.	Retail
2JZ-GE/GTE	C4851	\$41.19

Intake Manifold Gasket		
Application	Part No.	Retail
2JZ-GE	C4849	\$116.74

Exhaust Manifold Gaskets		
Application	Part No.	Retail
2JZ-GE .064" AM	C4847-064	\$42.26
2JZ-GTE .030" MLS	C4209-030	\$92.91

Cam Seal Set		
Application	Part No.	Retail
2JZ-GE	C4850	\$17.57

Valve Stem Seals (sold individually)		
Application	Part No.	Retail
2JZ-GE/GTE	3225V	\$2.04

Throttle Body Gasket		
Application	Part No.	Retail
2JZ-GE	C4848	\$6.57

Thermostat Gasket Set		
Application	Part No.	Retail
2JZ-GE/GTE	C4852	\$6.55

Water Pump Gasket		
Application	Part No.	Retail
2JZ-GE/GTE	C4854-031	\$20.57

Rear Main Seal		
Application	Part No.	Retail
2JZ-GE/GTE	C4853	\$19.88

Oil Pan Gasket		
Application	Part No.	Retail
Automatic Transmission	C14118-060	\$22.92

Gasket Kits



To purchase a complete gasket kit order both top end and bottom end gasket kit

TOP END GASKET KIT

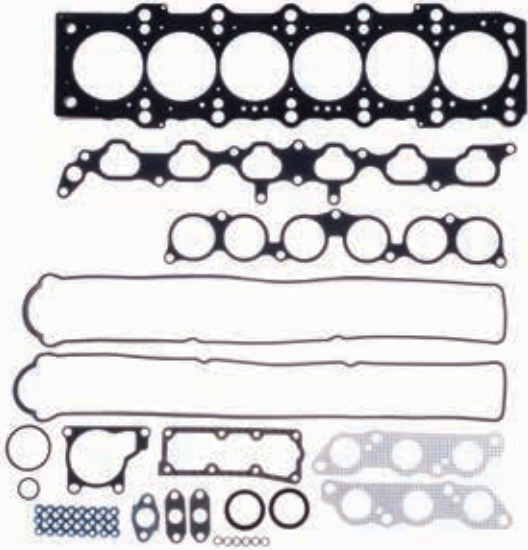

Application	Part No.	Retail
2JZ-GE 93-98 87mm Bore	PRO2021T	\$435.67

BOTTOM END GASKET KIT



Application	Part No.	Retail
2JZ-GE/GTE 93-98	PRO2021B	\$83.37

B58/B58H 3.0L Inline 6 B58B30C/B58B3001 2020+ Toyota Supra

Head Gaskets

MLX Head Gasket				
Bore	Thickness	Pkg Qty	Part No.	Retail
83mm	.036"	1	C14144-036	\$201.10

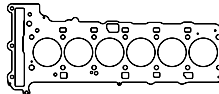

Additional thicknesses available
see pages 2 - 4

DST Head Gasket				
Bore	Thickness	Pkg Qty	Part No.	Retail
83mm	.063"	1	C14208-063	302.17
83mm	.071"	1	C14208-071	302.17

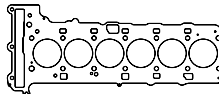

NEW!

See page 166 for additional gaskets



TOYOTA

B58/B58H 3.0L Inline 6 B58B30C/B58B3001 2020+ Toyota Supra (continued)

Individual Gaskets

Exhaust Manifold Gasket		
Application	Part No.	Retail
B58/B58H Exhaust Gasket	C14198-030	\$30.81

5VZ-FE 3.4L V6: 95-99 Tacoma, 95-98 T100, 95-99 4 Runner, 2000-04 Tundra, 96-99 Landcruiser, 00 Hi-Lux

Head Gaskets

MLS Head Gasket - Left Side				
Bore	Thickness	Pkg Qty	Part No.	Retail
98mm	.040"	1	C4215-040	\$107.24

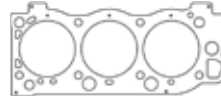

Additional thicknesses available see pages 2 - 4

MLS Head Gasket - Right Side				
Bore	Thickness	Pkg Qty	Part No.	Retail
98mm	.040"	1	C4214-040	\$107.24

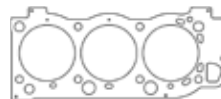

1UZ-FE 4.0L 32v V8 w/o VVTi 90-98 LS400, 92-98 SC300, 92-98 SC400

Head Gaskets

MLS Head Gasket - Left Side				
Bore	Thickness	Pkg Qty	Part No.	Retail
89mm	.051"	1	C14151-051	\$112.58
92.5mm	.051"	1	C4137-051	\$112.58

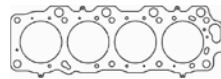

Additional thicknesses available see pages 2 - 4

MLS Head Gasket - Right Side				
Bore	Thickness	Pkg Qty	Part No.	Retail
89mm	.051"	1	C14152-051	\$112.58
92.5mm	.051"	1	C4136-051	\$112.58

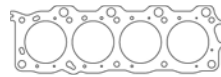

1UR-FE/1UR-FSE/2UR-FSE/2UR-GSE/3UR-FE/3UR-FBE 2006+

Head Gaskets

MLS HP Head Gasket - Left Side				
Bore	Thickness	Pkg Qty	Part No.	Retail
97mm	.034"	1	C4993-034	\$112.35

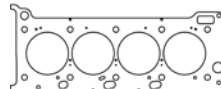

Additional thicknesses available see pages 2 - 4

MLS HP Head Gasket - Right Side				
Bore	Thickness	Pkg Qty	Part No.	Retail
97mm	.034"	1	C4994-034	\$112.35

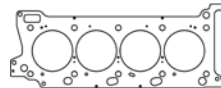

Individual Gaskets

Exhaust Manifold Gasket Set		
Application	Part No.	Retail
1UR-FE/3UR-FBE/3UR-FE	C14125-040	\$70.85

2GR-FE 3.5L V6 3456cc 2005 Avalon, 2006 RAV4, 2008 Highlander

Head Gaskets

MLS Head Gasket - Left Side				
Bore	Thickness	Pkg Qty	Part No.	Retail
94.5mm	.045"	1	C4582-045	\$112.58

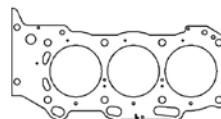

Additional thicknesses available see pages 2 - 4

MLS Head Gasket - Right Side				
Bore	Thickness	Pkg Qty	Part No.	Retail
94.5mm	.045"	1	C4581-045	\$112.58

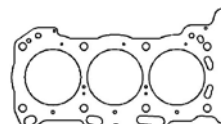

TOYOTA

1GR-FE 4.0L V6 Single VVT-i: 2003-09 4Runner, 2007-10 FJ Cruiser, 2005-15 Tacoma, 2005-11 Tundra

Head Gaskets

MLS Head Gasket - Left Side

Bore	Thickness	Pkg Qty	Part No.	Retail
95.5mm	.027"	1	C4556-027	\$112.58
96.5mm	.036"	1	C14054-036	\$112.58
96.5mm	.045"	1	C14054-045	\$112.58

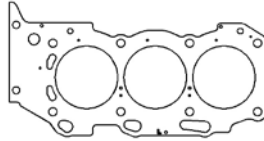

Additional thicknesses available
see pages 2 - 4

MLS Head Gasket - Right Side

Bore	Thickness	Pkg Qty	Part No.	Retail
95.5mm	.027"	1	C4557-027	\$112.58
96.5mm	.036"	1	C14045-036	\$112.58
96.5mm	.045"	1	C14045-045	\$112.58

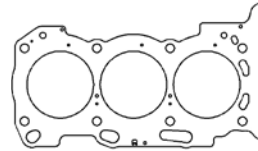

Individual Gaskets

Oil Pan Gasket

Application	Part No.	Retail
05-17 Lower (1GR-FE/2GR/2TR-FE/2GR-FKS)	C14113-060	\$22.92
Automatic Trans - 19 Bolt (1UZ/2UZ/7MGTE)	C14118-060	\$22.92
Automatic Trans - 20 Bolt (1UR/3UR/4GR-FSE)	C14122-060	\$22.92

Intake Manifold Gasket Set

Application	Part No.	Retail
03-15 1GR-FE Set of 2	C14127-020	\$17.67

Exhaust Manifold Gasket Set

Application	Part No.	Retail
07-15 1GR-FE Set of 2	C14116-064	\$22.92

1FZ-FE 4.5L DOHC Inline 6: 1993-97 Landcruiser, 1996-97 Lexus 450

Head Gaskets

MLS Head Gasket

Bore	Thickness	Pkg Qty	Part No.	Retail
101.5mm	.053"	1	C4530-053	\$240.83

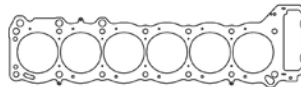

Additional thicknesses available
see page 1 & 2

MLX Head Gasket

Bore	Thickness	Pkg Qty	Part No.	Retail
101.5mm	.040"	1	C4611-040	\$221.75

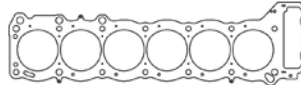

2UZ-FE 4.7L 32v V8 1998 Landcruiser, 2004 GX470, 2004 4 Runner, 2001-04 Tundra, 2001-04 Sequoia, 1998-00 LX470

Head Gaskets

MLS Head Gaskets - Left Side

Bore	Thickness	Pkg Qty	Part No.	Retail
92mm	.040"	1	C4358-040	\$112.58
98mm	.040"	1	C4212-040	\$112.58

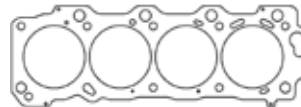

Additional thicknesses available
see page 1 & 2

MLS Head Gaskets - Right Side

Bore	Thickness	Pkg Qty	Part No.	Retail
92mm	.040"	1	C4357-040	\$112.58
98mm	.040"	1	C4211-040	\$112.58

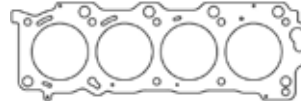

Individual Gaskets

Oil Pan Gasket

Application	Part No.	Retail
Automatic Trans - 20 Bolt (1UR/3UR/4GR-FSE)	C14122-060	\$22.92



TOYOTA

PH11 Race V8

Head Gaskets

MLS Head Gasket - Left Side

Bore	Thickness	Pkg Qty	Part No.	Retail
4.200"	.040"	1	C5584-040	\$132.81



Additional thicknesses available
see pages 2 - 4

MLS Head Gasket - Right Side

Bore	Thickness	Pkg Qty	Part No.	Retail
4.200"	.040"	1	C5583-040	\$132.81



TRIUMPH

1966-74 Spitfire 1500cc

Head Gasket

Copper Head Gasket

Bore	Thickness	Pkg Qty	Part No.	Retail
74mm	.043"	1	C4153-043	\$107.86

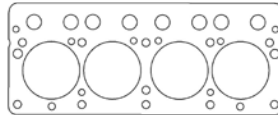

Additional thicknesses available
see pages 2 - 4

1961-65 TR4 2138cc Pushrod

Head Gasket

CFM-20 Head Gasket

Bore	Thickness	Pkg Qty	Part No.	Retail
88mm	.043"	1	C4152-043	\$93.79

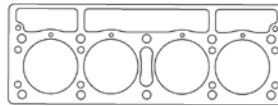

Additional thicknesses available
see pages 2 - 4

1969-71 TR6 2498cc Inline 6 Pushrod

Head Gasket

Copper Head Gasket

Bore	Thickness	Pkg Qty	Part No.	Retail
76mm	.043"	1	C4154-043	\$107.86

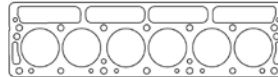

Additional thicknesses available
see pages 2 - 4

TVR

Speed Six 3.6/4.0L: 1999-06 Tuscon, 1996-06 Cerbera, 2002-06 Tamora, 2002-06 T350, 2004-06 Sagaris

Head Gasket

MLS Head Gasket

Bore	Thickness	Pkg Qty	Part No.	Retail
96.5mm	.060"	1	C4527-060	\$262.01

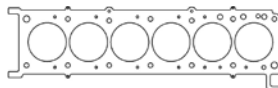

Additional thicknesses available
see pages 2 - 4

VAUXHALL / OPEL

C16XE, X16XE, X16XEL, Y16XE: 1994-98 Astra, 1993-94 Corsa B GSI, 1994-00 Tigra 16v

Head Gasket

MLS Head Gasket

Bore	Thickness	Pkg Qty	Part No.	Retail
82mm	.051"	1	C4257-051	\$107.24

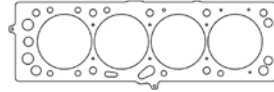

Additional thicknesses available
see pages 2 - 4

20XE, C20XE, C20LET: 1992-97 Calibra Turbo, 1987-91 Kadett E 16v, 1993-95 Vectra A Turbo

Head Gaskets

MLS Head Gasket

Bore	Thickness	Pkg Qty	Part No.	Retail
88mm	.051"	1	C4216-051	\$107.24

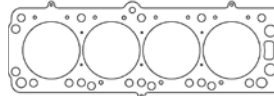

Additional thicknesses available
see pages 2 - 4

MLX Head Gasket

Bore	Thickness	Pkg Qty	Part No.	Retail
88mm	.050"	1	C4960-050	\$132.81

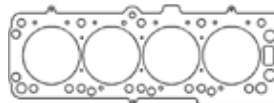

20E, 20N, 20S CIH 2.0L: 1983-88 Manta B, 1978-81 Ascona, 1976-80 Rekord, 1983-84 Monza, 1977-79 Kadett

Head Gasket

MLS Head Gasket

Bore	Thickness	Pkg Qty	Part No.	Retail
97mm	.051"	1	C4512-051	\$181.34

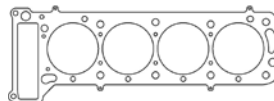

Additional thicknesses available
see pages 2 - 4

VOLKSWAGEN / AUDI

1.4L 1390cc DOHC TFSI 2007+: BMY, BLG

Head Gaskets

MLX Head Gasket

Bore	Thickness	Pkg Qty	Part No.	Retail
77mm	.032"	1	C4980-032	\$132.81

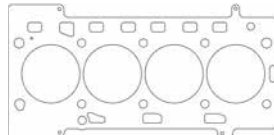

Additional thicknesses available
see pages 2 - 4

Individual Gaskets

Exhaust Manifold Gasket Sets

Application	Part No.	Retail
1.4L DOHC 16v MLS	C4975-030	\$24.76

1.8L AGB, 2H, GX, HT, JH, JN, MZ, PG, PF, RD, RV, PL 2.0L: 9A - Golf Mk2/Mk3, Jetta Mk2/Mk3, Passat B2/B3/B4, Audi 80/100, Seat Ibiza Mk2

Head Gaskets

MLS Head Gaskets

Bore	Thickness	Pkg Qty	Part No.	Retail
83mm	.051"	1	C4247-051	\$107.24
85mm	.051"	1	C4246-051	\$107.24

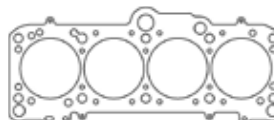

Additional thicknesses available
see pages 2 - 4

Individual Gaskets

Exhaust Manifold Gasket Sets

Application	Part No.	Retail
1.8L 8v MLS - 4pcs	C4163-030	\$41.48
1.8L 16v MLS - 4pcs	C4210-030	\$41.48



VOLKSWAGEN / AUDI

1.8L Turbo 1998-06 AEB, AGU, AJH, APH, ARX, ARZ, ATW, AUM, AVC, AWD, AWL, AWT, AWW, BJX, BKF, BKV, CFMA, AYP, CED, AMB, AWM, AJQ, APP, ARY, ATC, AUQ, AWP, BEK, BNU, BEX, BVR, AMU, AMK, BAM, BEA

Head Gaskets

MLS Head Gaskets				
Bore	Thickness	Pkg Qty	Part No.	Retail
82mm	.051"	1	C4558-051	\$107.24
85mm	.051"	1	C4559-051	\$107.24

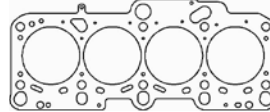

Additional thicknesses available
see pages 2 - 4

2.0L TFSI 16v DOHC (belt driven): Golf GTI 2004-08, A3, A4, A6, Jetta, Passat 2005-08, TT, EOS 2006-08, Seat Leon 2005-08 (AXX, BPY, BWA, BPJ, BUL, BWE, BRC, BWT, BYK)

Head Gasket

MLS Head Gasket				
Bore	Thickness	Pkg Qty	Part No.	Retail
83.5mm	.051"	1	C4541-051	\$107.24

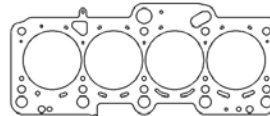

Additional thicknesses available
see pages 2 - 4

Individual Gaskets

Exhaust Manifold Gasket Sets			
Application	Part No.	Retail	
2.0L DOHC 16v MLS 2005-14	C4972-030	\$24.76	

2.0L 16v DOHC 2008-11 (chain driven): A3, A4, A6, A3, A4, A5, Q5, TT, 2009-11 CC, 2008-11 Jetta, 2008-10 Passat

Head Gaskets

MLS Head Gasket				
Bore	Thickness	Pkg Qty	Part No.	Retail
82.5mm	.040"	1	C4976-040	\$107.24
84mm	.040"	1	C4977-040	\$107.24



Additional thicknesses available
see pages 2 - 4

Individual Gaskets

Exhaust Manifold Gasket Sets			
Application	Part No.	Retail	
2.0L DOHC 16v MLS 2005-14	C4972-030	\$24.76	

2.0L 8v EA113 1998-2015

Head Gaskets

MLS Head Gasket				
Bore	Thickness	Pkg Qty	Part No.	Retail
84mm	.040"	1	C14124-040	\$107.24

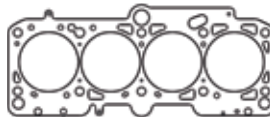

Additional thicknesses available
see pages 2 - 4

2.0L 16v DOHC 2012-Present (chain driven): A1, A3, A4, A5, Q3, Q5, TT

Head Gaskets

MLS Head Gasket				
Bore	Thickness	Pkg Qty	Part No.	Retail
83mm	.040"	1	C4978-040	\$107.24
84mm	.040"	1	C4979-040	\$107.24

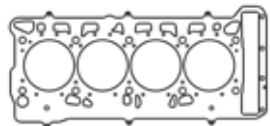

Additional thicknesses available
see pages 2 - 4

Individual Gaskets

Exhaust Manifold Gasket Sets			
Application	Part No.	Retail	
2.0L DOHC 16v MLS 2005-14	C4972-030	\$24.76	

VOLKSWAGEN / AUDI

1.8L 16V DOHC (CNSA, CNSB, CPRA, CPKA, CXBA, CXBB) 2.0L 16v DOHC (CJXC, CXBB, CXCA, CNTC, CPPA, CPLA CXCB, CYFB, CYMC, CYNB, CZRA, DBPA, EA113)

Head Gaskets

MLX Head Gasket

Bore	Thickness	Pkg Qty	Part No.	Retail
83mm	.036"	1	C14009-036	\$132.81

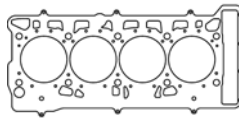

Additional thicknesses available
see pages 2 - 4

2.5L 20V TFSI DAZA, DNWA

Head Gaskets

MLX Head Gasket

Bore	Thickness	Pkg Qty	Part No.	Retail
83.5mm	.055"	1	C14145-055	\$177.65

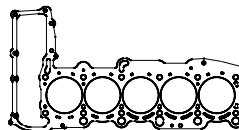

Additional thicknesses available
see pages 2 - 4

3.0L 24V V6 Audi 2010-16 S4, S5 2010-17, A6 2009-17, A7 2012-17, A8 2013-16 Q5 2013-17, Q7 2011-19, SQ5 2014-17

Head Gaskets

MLX Head Gasket - Right Side

Bore	Thickness	Pkg Qty	Part No.	Retail
85mm	.036"	1	C14153-036	\$110.88

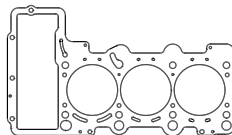

Additional thicknesses available
see pages 2 - 4

MLX Head Gasket - Left Side

Bore	Thickness	Pkg Qty	Part No.	Retail
85mm	.036"	1	C14154-036	\$110.88

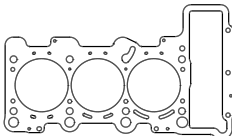

2.9L, 3.0L EA839 V6 Audi 2019-24 A6, 2019-24 A7, 2019-24 A8, 2020-24 Q7, 2019-24 Q8, 2018-2024 RS5, 2018-24 S4, 2018-24 S5, 2020-24 S6, 2020-24 S7, 2018-24 SQ5

Head Gaskets

NEW!

MLX Head Gasket - Right Side

Bore	Thickness	Pkg Qty	Part No.	Retail
86mm	.032"	1	C14195-032	\$110.88

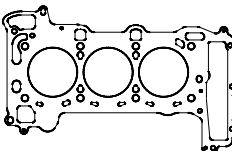

Additional thicknesses available
see pages 2 - 4

NEW!

MLX Head Gasket - Left Side

Bore	Thickness	Pkg Qty	Part No.	Retail
86mm	.032"	1	C14196-032	\$110.88

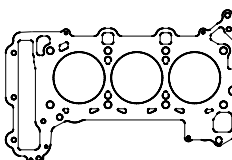



VOLKSWAGEN/AUDI

2.8L VR6 24V 2002-05 Golf GTI

Head Gaskets

MLX Head Gasket

Bore	Thickness	Pkg Qty	Part No.	Retail
84mm	.032"	1	C14184-032	\$126.63

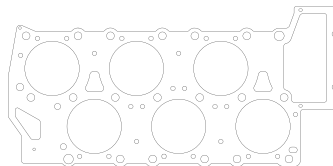

Additional thicknesses available
see pages 2 - 4

3.2L VR6 24v 2004-09: Golf Mk4 R32

Head Gaskets

MLS Head Gasket

Bore	Thickness	Pkg Qty	Part No.	Retail
83mm	.030"	1	C4968-030	\$126.63

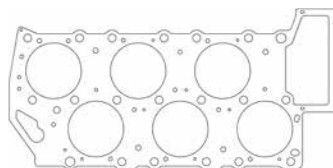

Additional thicknesses available
see pages 2 - 4

Individual Gaskets

Throttle Body Gasket

Application	Part No.	Retail
3.2L VR6	C14027-060	\$6.57

Intake Manifold Gasket

Application	Part No.	Retail
2007-08 Eos, 2003-04 Golf	C14029-060	\$24.19

VOLVO

B18A/B/D 1.8L 1961-68, B20A/B/E/F 2.0L 1969-81

Head Gasket

MLS Head Gasket

Bore	Thickness	Pkg Qty	Part No.	Retail
86mm	.045"	1	C4287-045	\$134.02
90mm	.045"	1	C4288-045	\$134.02
92mm	.045"	1	C4289-045	\$134.02
93mm	.045"	1	C14085-045	\$134.02

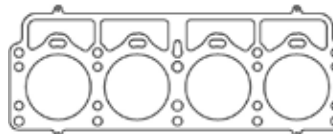

Additional thicknesses available
see pages 2 - 4

B19A/E/ET 2.0L 1976-84, B200E/ET/F/K 2.0L 1985-95, B21E/F/FT 2.1L 1975-85

Head Gasket

MLS Head Gasket

Bore	Thickness	Pkg Qty	Part No.	Retail
92mm	.045"	1	C4498-045	\$134.02
92mm	.098"	1	C4498-098	\$174.23
100.5mm	.045"	1	C14093-045	\$134.02

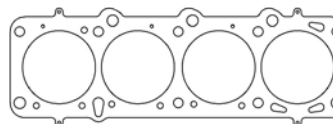

Additional thicknesses available
see pages 2 - 4

B23A/E/F/FT/K 2.3L 1978-84, B230A/E/F/FT/K 2.3L 1985-98

Head Gasket

MLS Head Gasket

Bore	Thickness	Pkg Qty	Part No.	Retail
97mm	.045"	1	C4499-045	\$134.02
98mm	.051"	1	C14094-051	\$134.02
100.5mm	.045"	1	C14093-045	\$134.02

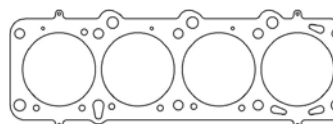

Additional thicknesses available
see pages 2 - 4

Fel-Pro Part No.	Cometic Part No.
1003	C5272-040
1008	C5456-040
1009	C5462-040
1013	C5871-040
1014	C5249-040
1016	C5712-040
1018	C5667-040
1020	C5840-040
1021	C5481-040
1028	C5668-040
1034	C15498-040
1035	C5709-040
1043	C15604-040
1046	C5485-051
1047	C5333-040
1047	C15656-040
1067	C5334-040
1133	C5481-040
1133	C5511-040
1135	C15622-040
1143	C5248-040
1144	C5249-040
1152	C5911-045
1200	C5694-060
1201	C5792-060
1204	C5544-060
1205	C15580-060
1205	CP15580
1206	C15609-060
1207	C15686-060
1208	C15687-060
1209	C15688-060
1210	C15041-060
1210	C15693-060
1211	C15689-060
1212	C15041-060
1213	C15690-060
1216	C15691-060
1218	C15692-060
1230	C5043-060
1231	C5206-060
1233	C5778-060
1234	C5598-060
1246	C5137-060
1250	CP15648
1262	C15610-060
1262	CP5652
1277	C5541-031
1282	C5541-060

Fel-Pro Part No.	Cometic Part No.
1298	C5342-060
1356	C5813-060
1357	C5775-060
1404	C15612-060
1405	C15611-060
1411	C5349-030
1412	C5251-030
1413	C5901-030
1414	C5902-030
1415	CP5898
1419	C5900-030
1423	C5147-064
1424	C5905-030
1426	C5891-030
1427	CP15650
1427	C15683-030
1439	C5904-030
1442	C5922-030
1462	C5965-030
1470	C5895-030
1487	CP15651
1612	C5983
1623	C5044
1628	C5973
1628	C5973-2
1628	C5973PR
1629	C5976
1635	C5975
1635	C5975-2
1643	C15467
1644	C15608
1649	C15613-188
1658	C15440
1678	C15579
1678	C15579-2
1684	C5974-2
1684	C5974
1804	C5344
1810	C5279-094
1811	C5278-094
1818	C5294
1821	C5488-060
1823	C15269-094
1827	C15092
1839	C5104-094
1863	C15607
1866	C15077
1886	C5072
1900	C5263FC

Fel-Pro Part No.	Cometic Part No.
1901	C5262
1901	C5262FC
1904	C15184FC
1935	C15616
2302	C5848-032
2324	C15615
2324	CP15615
2331	CP5276
2400	C15619
2900	C5680
2901	C5688
2904	C5682
2912	C5680
2919	C5106
2920	C5087
5152	C15618
5152	C5299-018
5182	C15617
6579	C5642-031
13267	C15093
30060	C5347-039
35005	C4948
35019	C15094
35062	C5538-047
35066	C5353
35214	C15095
35235	C4812-039
35249	C4913
35273	C4696
35278	C4839
35294	C4818-031
35326	C4804-020
35336	C4716-032
35340	C4941
35352	C15098
35380	C15096
35385	C4846-031
35397	C15097
35415	C4777-015
35480	C4659
35483	C4774-031
35495	C4728-020
35569	C4792-031
35642	C4831
35643	C4835-020
35644	C4831
35747	C4860-018
35752	C4917
35753	C4751

Fel-Pro Part No.	Cometic Part No.
35943	C4918
35946	C4919
60818	C4733-018
60859	C15101
60879	C4693
60889	C4904
60920	C4867-060
60971	C4681
60973	C4672-032
60979	C4657-032
61065	C4667-032
61067	C4656-032
61354	C4911
61359	C4877-060
61360	C4874-060
61634	C4882
61697	C15441
70194	C5531-060
70262	C15099
71217	C14132-010
72663	C4824
1077041	C5331-040
1011-1	C5514-040
1011-2	C5514-040
1017-1	C5330-040
1017-2	C5330-051
1135SD-4	C15624-041
1141L	C5118-036
1141R	C5119-036
1144-053	C5249-051
1153-1	C4235-051
1161L041	C5489-040
1206-S3	C15614-059
1250 S-3	C5652-060
1252-3	C5649-060
1262R	CP15649
1884R	C15550
2302-1	C15605-032
26182PT	C4558-045
26192PT	C5489-051
26208PT	C5015-075
26209PT	C5016-075
26541PT	C15658-032
26542PT	C15659-032
26666PT	C15429-054
26682PT	C15430-054
8530PT-1	C5956-040
8559PT-1	C15655-049
9076 PT-1	C5988-050

Fel-Pro Part No.	Cometic Part No.
BS40245	C5564
BS40345-1	C4843
BS40408-1	C4697
BS40427	C4823
BS40430	C4663
BS40535	C4705
BS40562	C4720
BS40613	C5707
BS40634	C4783
BS40637	C4832
BS40640	C5172
BS40648	C4699
CS26550-1	PRO1049B
CS26565	PRO3007B
CS26568	PRO1048B
CS8180-2	PRO1045B
CS8523	PRO1046B
HS26404PT	PRO2054T
HS26550PT	PRO1049T
HS26568PT	PRO1048T
HS8523PT-2	PRO1047T
HS9502PT	PRO1046T
MS90000	C5898HTS
MS90175	C5611-060
MS90206	C5897HTS
MS90832	C4937-064
MS91395	C4908
MS91484	C4671-060
MS91485	C4666
MS91679	C4936
MS91680	C4938-064
MS91815-1	C4715-042
MS92148	C4806
MS92438	C5165
MS92467	C5818HTS
MS92504	C4674
MS92672	C4828-032
MS92692	C4462
MS9275B	C5892HTS
MS92939	C4805-042
MS92968	C4939-064
MS93233	C4813
MS93362	C4707-046
MS93353	C4909
MS93550-1	C4819-046
MS93795-3	C4714
MS93856	C4934-032
MS93909	C4205-030
MS94054	C5548-064

Fel-Pro Part No.	Cometic Part No.
MS94119-2	C4702-060
MS94328	C4692-060
MS94357	C4760
MS94537	C4779-060
MS94611	C14033-060
MS94612-1	C14030-018
MS94626	C4772
MS94628	C4771-064
MS94946	C4723
MS95082	C4724-064
MS95088	C4204-030
MS95480	C5558-064
MS96105	C4872-059
MS96106	C4875-060
MS96476	C14095
MS96477	C4668
MS96536	C4748
MS96587	C5166
MS96788	C15042-040
MS96905	C5854-030
MS97161	C14166
MS97215	C15444
MS97256	C5041-030
MS97402	C15599
MS97405	C5020-021
MS97406	C15567HT
MS98017	C15574HT
OS20102C	C4940
OS30460A	C4695
OS30468C	C4817-062
OS30542R	C4660
OS30570C	C4717
OS30591	C4776
OS30630R	C4676
OS30632R	C4158
OS30642C	C4834
OS30644C	C4764-060
OS30665C	C4698
OS30690R	C4899
OS30691R	C4670
OS30693R	C5173
OS30693R	CP5173
OS30787	C14114-060
OS34308R	C15710
OS34405	C4845-062
OS34500R	C5072
RDS13089	C15214
RDS13270	C15222
RDS13314-1	C15216

Fel-Pro Part No.	Cometic Part No.
RDS13391	C15227
RDS13889	C15212
RDS55008	C15226
RDS55019	C15213
RDS55028-1	C15232
RDS55029	C15228
RDS55029	C15228FC
RDS55047	C15220
RDS55063	C15234
RDS55072	C15229
RDS55075	C15231
RDS55341	C15223
RDS55387	C15233
RDS55390	C15230
RDS55391	C15219
RDS55394	C15221
RDS55447	C15218
RDS55476	C15225
RDS6095-1	C15217
RDS6629	C15215
TCS13198	C5053
TCS13417	C5070
TCS45002	C5050
TCS45060	C5057
TCS45061	C5066
TCS45117	C5047
TCS45424	C4808
TCS45483	C4905
TCS45568	C4942
TCS45641	C4821
TCS45685	C4943
TCS45696	C4914
TCS45718	C4709
TCS45786	C4739
TCS45887-1	C4915
TCS45897	C4833
TCS45901	C4725
TCS45953	C5054
TCS45956	C5055
TCS45996	C5060
TCS46008	C4870
TCS46008	C4866
TCS46049	C5202
TCS46139	C4675
TCS46140-1	C4878
TCS5124-1	C5052
TOS18583	C15246
TOS18608	C15252
TOS18621	C15253

Fel-Pro Part No.	Cometic Part No.
TOS18628	C15249
TOS18633	C15254
TOS18634	C15248
TOS18663	C15251
TOS18667	C15469
TOS18679	C15247
TOS18698	C15250
VS13403	C15440
VS26081R	C4935
VS50041R	C4691
VS50068R	C5659-125
VS50090R	C5975
VS50184R	C15468
VS50268R	C4807
VS50277R	C15006-125
VS50279B	C4800-059
VS50293R	C15206
VS50303R	C4838
VS50304R1	C4820
VS50326R	C4701
VS50361R	C4781
VS50362R	C4679
VS50377R	C5178
VS50377R1	C5178
VS50384R	C4747
VS50385R	C4761
VS50390R	C4722
VS50393R	C4608
VS50396R	C15066-1
VS50455R	C15046
VS50461R	C4713
VS50477R	C5177
VS50498R	C4628
VS50499R	C4655
VS50500R	C4665
VS50504R	C5170
VS50512R	C4830
VS50517R	C4631
VS50555R	C4873
VS50561R	C4642
VS50574R	C4788
VS50581R	C4644
VS50620R	C4928
VS50620R	C4880
VS50625R	C5193PR
VS50696R	C4766
VS50780R	C14026
VS50811R	C15576
VS50820R	C15151
VS50902R	C15442



Scan here to
download catalog

8090 Auburn Road • Concord, OH 44077

1 (440) 354-0777

1 (440) 354-0350

info@cometic.com

facebook.com/cometic

www.cometic.com

[@cometicgasket](https://www.instagram.com/cometicgasket)



Copyright 2026 Cometic Gasket, Inc.

Photos courtesy of: Automobile Racing Club of America, Bigfoot 4X4, Elite Motorsports, High Limit Racing, Michael Lewis Racing, Open Wheel Showdown, Davey Hamilton Jr., RCR Enterprises, LLC, Rico Abreu Racing, Roush Yates Engines, Shane McDowell Racing, Spire Motorsports



California, Proposition 65 Warning. The state of California has determined that certain chemicals used in the manufacture of this product have been known to cause cancer and birth defects. For more information, visit www.p65Warnings.ca.gov

AB2026
Printed in U.S.A.